

# Glossary of Symbols

$\ A\ $	norm of linear map	$f A$	restriction of map $f$ to subset $A$	$M \# N$	connected sum, 191	$V_n$	Stiefel manifold of $k$ -frames in $\mathbb{R}^n$ , 78
Bd $X$	boundary of set $X$	$F^*$	evaluation map of $F$ , 79	$M_x$	tangent space to $M$ at $x$ , 17	$W$ (subscript)	weak topology, 35
$CP^n$	complex projective $n$ -space, 14	$f'(x)$	derivative at $x$ of map of interval, 20	$M_x^*$	cotangent space to $M$ at $x$ , 143	$ X $	norm of vector $X$
$C^r$	(of map) having $r$ continuous derivatives, 9, 15, 214	$f^*\xi$	pullback of vector bundle $\xi$ by map $f$ , 97	$\mathfrak{N}^n$	unoriented cobordism group, 170	$X(\xi)$	Euler number of vector bundle $\xi$ , 133
$C^\infty$	infinitely differentiable	$\Phi W$	induced differential structure, 13	$\mathcal{N}^r(f; \Phi, \Psi, K, \varepsilon)$	strong basic neighborhood, 35	$[X, Y]$	set of homotopy classes of maps from $X$ to $Y$
$C^*$	real analytic	$gf, g \circ f$	composition of maps	$\Omega^r$	oriented cobordism group, 170	$\xi$	fibre of vector bundle $\xi$ over $x$
$C^r(M, N)$	set of $C^r$ maps from $M$ to $N$ , 34	$GL(n)$	group of invertible real $n \times n$ matrices	$\nu_k$	$k$ th type number of Morse function, 160	$\xi \oplus \eta$	Whitney sum of vector bundles, 94
$C(X, Y)$	set of continuous maps from $X$ to $Y$	$G_{n, k}$	Grassmann manifold of $k$ -planes in $\mathbb{R}^n$ , 14	$(\nu_0, \dots, \nu_n)$	type of Morse function, 160	$\bar{X}$	closure of set $X$
$\chi$	Euler characteristic, 133	grad $f$	gradient vector field of function $f$ , 152	$O(n)$	group of real orthogonal $n \times n$ matrices	$\langle x, y \rangle$	inner product of vectors, 95
$\chi'$	homological Euler characteristic, 161	$\gamma_{n, k}$	universal or Grassmann bundle over $G_{n, k}$ , 99	$\omega^n$	standard orientation of $\mathbb{R}^n$ , 103	$\eta^\perp$	orthogonal complement of subbundle $\eta$ , 95
deg	degree of map, 124	$H_k$	disk with $k$ holes, 203	$\Omega^r$	oriented cobordism group, 170	$Z^*$	zero section of $T^*M$ , 143
Det	determinant	$H_n(X, A)$	singular homology group, 161	$P^n$	real projective $n$ -space, 14	$l_w$	identify map of $M$ , 19
$Df$	derivative of $f$ , 20, 214	$H_n(X, A; F)$	singular homology vector space with coefficients in field $F$ , 161	Prop $^r(M, N)$	set of proper $C^r$ maps from $M$ to $N$	$\#(M, N)$	intersection number of $M, N$ in $W$ , 132
$D_\varepsilon(\xi)$	closed disk subbundle of $\xi$ of radius $\varepsilon$	$H_n(X, A; F)$	singular homology vector space with coefficients in field $F$ , 161	$\pi_n(X)$	$n$ th homotopy group of $X$	$\#(M, N; W)$	intersection number of $M, N$ in $W$ , 132
Diff $^r(M)$	set of $C^r$ diffeomorphisms of $M$	$H_n(X, A; F)$	singular homology vector space with coefficients in field $F$ , 161	$\mathbb{R}^n$	Euclidean $n$ -space	$\#(f, g)$	intersection number of maps $f, g$ , 139
dim	dimension, 11	$H_n(X, A; F)$	singular homology vector space with coefficients in field $F$ , 161	$S$ (subscript)	strong topology 35, 59	$\approx$	relation of diffeomorphism, 16
$D^k f$	$k$ 'th derivative of $f$	$H_n(X, A; F)$	singular homology vector space with coefficients in field $F$ , 161	$S^n$	unit $n$ -sphere, 8	$\cong$	relation of homotopy
$D^n$	(closed) unit disk in $\mathbb{R}^n$ , 23	$H_n(X, A; F)$	singular homology vector space with coefficients in field $F$ , 161	$SO(n)$	group of orthogonal real $n \times n$ matrices of determinant 1	$\equiv$	relation of vector bundle isomorphism, 88
$\Delta, M_\Delta$	diagonal, 25	$H_n(X, A; F)$	singular homology vector space with coefficients in field $F$ , 161	Supp $g$	support of function $g$ , 43	$\sim$	relation to cobordism, 164
$\partial M$	boundary of manifold $M$ , 30	$H_n(X, A; F)$	singular homology vector space with coefficients in field $F$ , 161	$\sum$	set of critical points of $f$ , 69	$\hookrightarrow$	embedding, 21
$\partial$ -manifold	manifold with boundary, 30	$H_n(X, A; F)$	singular homology vector space with coefficients in field $F$ , 161	$T_x M$	restriction of $TM$ to $A \subset M$ , 17	$\uparrow$	set of $C^r$ maps transverse to submanifold $A$ , 74
$E^*$	Thom space of vector bundle $E$ , 172	$H_n(X, A; F)$	singular homology vector space with coefficients in field $F$ , 161	$Tf, T.f$	tangent of map, 18	$\uparrow$	relation of transversality, 74
$e^k$	$k$ -cell, 157	$H_n(X, A; F)$	singular homology vector space with coefficients in field $F$ , 161	$TM$	tangent vector bundle of $M$ , 17	$\emptyset$	the empty set
$e^{n-k}$	dual $(n - k)$ -cell, 160	$H_n(X, A; F)$	singular homology vector space with coefficients in field $F$ , 161	$T^*M$	cotangent bundle of $M$ , 143	$X'$	homological Euler characteristic, 161
Emb $^r(M, N)$	set of $C^r$ embeddings of $M$ in $N$	$H_n(X, A; F)$	singular homology vector space with coefficients in field $F$ , 161	$T_x M$	restriction of $TM$ to $A \subset M$ , 17	$Z$	integers
$\varepsilon_n, \varepsilon^n$	trivial $n$ -dimensional vector bundle, 88	$H_n(X, A; F)$	singular homology vector space with coefficients in field $F$ , 161	$T_x M$	restriction of $TM$ to $A \subset M$ , 17	$Z_+$	positive integers
$\hat{F}$	track of isotopy $F$ , 111	$H_n(X, A; F)$	singular homology vector space with coefficients in field $F$ , 161	$T_x M$	restriction of $TM$ to $A \subset M$ , 17	$\mathbb{R}_+$	positive real numbers
		$H_n(X, A; F)$	singular homology vector space with coefficients in field $F$ , 161	$T_x M$	restriction of $TM$ to $A \subset M$ , 17	$X(M)$	Euler characteristic of manifold $M$ , 133

Graduate Texts in Mathematics 33

*Editorial Board*

J.H. Ewing F.W. Gehring P.R. Halmos

## Graduate Texts in Mathematics

- 1 TAKEUTI/ZARING. Introduction to Axiomatic Set Theory. 2nd ed.
- 2 OXTOBY. Measure and Category. 2nd ed.
- 3 SCHAEFFER. Topological Vector Spaces.
- 4 HILTON/STAMMBACH. A Course in Homological Algebra.
- 5 MAC LANE. Categories for the Working Mathematician.
- 6 HUGHES/PIPER. Projective Planes.
- 7 SERRE. A Course in Arithmetic.
- 8 TAKEUTI/ZARING. Axiomatic Set Theory.
- 9 HUMPHREYS. Introduction to Lie Algebras and Representation Theory.
- 10 COHEN. A Course in Simple Homotopy Theory.
- 11 CONWAY. Functions of One Complex Variable. 2nd ed.
- 12 BEALS. Advanced Mathematical Analysis.
- 13 ANDERSON/FULLER. Rings and Categories of Modules. 2nd ed.
- 14 GOLUBITSKY/GUILEMIN. Stable Mappings and Their Singularities.
- 15 BERBERIAN. Lectures in Functional Analysis and Operator Theory.
- 16 WINTER. The Structure of Fields.
- 17 ROSENBLATT. Random Processes. 2nd ed.
- 18 HALMOS. Measure Theory.
- 19 HALMOS. A Hilbert Space Problem Book. 2nd ed.
- 20 HUSEMOLLER. Fibre Bundles. 3rd ed.
- 21 HUMPHREYS. Linear Algebraic Groups.
- 22 BARNES/MACK. An Algebraic Introduction to Mathematical Logic.
- 23 GREUB. Linear Algebra. 4th ed.
- 24 HOLMES. Geometric Functional Analysis and Its Applications.
- 25 HEWITT/STROMBERG. Real and Abstract Analysis.
- 26 MANES. Algebraic Theories.
- 27 KELLEY. General Topology.
- 28 ZARISKI/SAMUEL. Commutative Algebra. Vol. I.
- 29 ZARISKI/SAMUEL. Commutative Algebra. Vol. II.
- 30 JACOBSON. Lectures in Abstract Algebra I. Basic Concepts.
- 31 JACOBSON. Lectures in Abstract Algebra II. Linear Algebra.
- 32 JACOBSON. Lectures in Abstract Algebra III. Theory of Fields and Galois Theory.
- 33 HIRSCH. Differential Topology.
- 34 SPITZER. Principles of Random Walk. 2nd ed.
- 35 WERMER. Banach Algebras and Several Complex Variables. 2nd ed.
- 36 KELLEY/NAMIOKA et al. Linear Topological Spaces.
- 37 MONK. Mathematical Logic.
- 38 GRAUERT/FRITZSCHE. Several Complex Variables.
- 39 ARVESON. An Invitation to  $C^*$ -Algebras.
- 40 KEMENY/SNELL/KNAPP. Denumerable Markov Chains. 2nd ed.
- 41 APOSTOL. Modular Functions and Dirichlet Series in Number Theory. 2nd ed.
- 42 SERRE. Linear Representations of Finite Groups.
- 43 GILLMAN/JERISON. Rings of Continuous Functions.
- 44 KENDIG. Elementary Algebraic Geometry.
- 45 LOËVE. Probability Theory I. 4th ed.
- 46 LOËVE. Probability Theory II. 4th ed.
- 47 MOISE. Geometric Topology in Dimensions 2 and 3.
- 48 SACHS/WU. General Relativity for Mathematicians.
- 49 GRUENBERG/WEIR. Linear Geometry. 2nd ed.
- 50 EDWARDS. Fermat's Last Theorem.
- 51 KLINGENBERG. A Course in Differential Geometry.
- 52 HARTSHORNE. Algebraic Geometry.
- 53 MANIN. A Course in Mathematical Logic.
- 54 GRAVER/WATKINS. Combinatorics with Emphasis on the Theory of Graphs.
- 55 BROWN/PEARCY. Introduction to Operator Theory I: Elements of Functional Analysis.
- 56 MASSEY. Algebraic Topology: An Introduction.
- 57 CROWELL/FOX. Introduction to Knot Theory.
- 58 KOBLITZ.  $p$ -adic Numbers,  $p$ -adic Analysis, and Zeta-Functions. 2nd ed.
- 59 LANG. Cyclotomic Fields.
- 60 ARNOLD. Mathematical Methods in Classical Mechanics. 2nd ed.
- 61 WHITEHEAD. Elements of Homotopy Theory.
- 62 KARGAPOLOV/MERLZJAKOV. Fundamentals of the Theory of Groups.
- 63 BOLLOBAS. Graph Theory.
- 64 EDWARDS. Fourier Series. Vol. I. 2nd ed.

*continued after index*

Morris W. Hirsch

## Differential Topology



Springer-Verlag

New York Berlin Heidelberg London Paris  
Tokyo Hong Kong Barcelona Budapest

Morris W. Hirsch  
Department of Mathematics  
University of California  
Berkeley, CA 94720  
USA

Dedicated to the memory of  
HENRY WHITEHEAD

*Editorial Board*

J.H. Ewing  
Department of  
Mathematics  
Indiana University  
Bloomington, IN 47405  
USA

P.R. Halmos  
Department of  
Mathematics  
Santa Clara University  
Santa Clara, CA 95053  
USA

F.W. Gehring  
Department of  
Mathematics  
University of Michigan  
Ann Arbor, MI 48109  
USA

---

Mathematics Subject Classification (1980): 34C40, 54Cxx, 57D05, 57D10, 57D12, 57D20, 57D55

---

Library of Congress Cataloging in Publication Data

Hirsch, Morris W 1933–

Differential topology.

(Graduate texts in mathematics; 33)

Bibliography: p. 209

Includes index.

I. Differential topology. I. Title.

II. Series

QA613.6.H57 514'.7 75-26615

© 1976 by Springer-Verlag New York Inc.

All rights reserved. This work may not be translated or copied in whole or in part without the written permission of the publisher (Springer-Verlag, 175 Fifth Avenue, New York, NY 10010, USA), except for brief excerpts in connection with reviews or scholarly analysis. Use in connection with any form of information storage and retrieval, electronic adaptation, computer software, or by similar or dissimilar methodology now known or hereafter developed is forbidden.

The use of general descriptive names, trade names, trademarks, etc. in this publication, even if the former are not especially identified, is not to be taken as a sign that such names, as understood by the Trade Marks and Merchandise Marks Act, may accordingly be used freely by anyone.

Typeset by Asco Trade Typesetting, Ltd., Hong Kong.

Printed and bound by R.R. Donnelley & Sons, Harrisonburg, Virginia.

Printed in the United States of America.

9 8 7 6 5 (Corrected fifth printing, 1994)

ISBN 0-387-90148-5 Springer-Verlag New York Berlin Heidelberg

ISBN 3-540-90148-5 Springer-Verlag Berlin Heidelberg New York



## *Preface*

This book presents some of the basic topological ideas used in studying differentiable manifolds and maps. Mathematical prerequisites have been kept to a minimum; the standard course in analysis and general topology is adequate preparation. An appendix briefly summarizes some of the background material.

In order to emphasize the geometrical and intuitive aspects of differential topology, I have avoided the use of algebraic topology, except in a few isolated places that can easily be skipped. For the same reason I make no use of differential forms or tensors.

In my view, advanced algebraic techniques like homology theory are better understood after one has seen several examples of how the raw material of geometry and analysis is distilled down to numerical invariants, such as those developed in this book: the degree of a map, the Euler number of a vector bundle, the genus of a surface, the cobordism class of a manifold, and so forth. With these as motivating examples, the use of homology and homotopy theory in topology should seem quite natural.

There are hundreds of exercises, ranging in difficulty from the routine to the unsolved. While these provide examples and further developments of the theory, they are only rarely relied on in the proofs of theorems.

## *Table of Contents*

### *Introduction*

1

### *Chapter 1: Manifolds and Maps*

- 0. Submanifolds of  $\mathbb{R}^{n+k}$  8
- 1. Differential Structures 11
- 2. Differentiable Maps and the Tangent Bundle 15
- 3. Embeddings and Immersions 21
- 4. Manifolds with Boundary 29
- 5. A Convention 32

### *Chapter 2: Function Spaces*

- 1. The Weak and Strong Topologies on  $C(M, N)$  34
- 2. Approximations 41
- 3. Approximations on  $\partial$ -Manifolds and Manifold Pairs 56
- 4. Jets and the Baire Property 58
- 5. Analytic Approximations 65

### *Chapter 3: Transversality*

- 1. The Morse–Sard Theorem 68
- 2. Transversality 74

### *Chapter 4: Vector Bundles and Tubular Neighborhoods*

- 1. Vector Bundles 86
- 2. Constructions with Vector Bundles 92
- 3. The Classification of Vector Bundles 99
- 4. Oriented Vector Bundles 103
- 5. Tubular Neighborhoods 109
- 6. Collars and Tubular Neighborhoods of Neat Submanifolds 113
- 7. Analytic Differential Structures 118

### *Chapter 5: Degrees, Intersection Numbers, and the Euler Characteristic*

- 1. Degrees of Maps 121
- 2. Intersection Numbers and the Euler Characteristic 131
- 3. Historical Remarks 140

Chapter 6: *Morse Theory*

1. Morse Functions 143
2. Differential Equations and Regular Level Surfaces 149
3. Passing Critical Levels and Attaching Cells 156
4. CW-Complexes 166

Chapter 7: *Cobordism*

1. Cobordism and Transversality 169
2. The Thom Homomorphism 172

Chapter 8: *Isotopy*

1. Extending Isotopies 177
2. Gluing Manifolds Together 184
3. Isotopies of Disks 185

Chapter 9: *Surfaces*

1. Models of Surfaces 189
2. Characterization of the Disk 194
3. The Classification of Compact Surfaces 200

*Bibliography*

209

*Appendix*

213

*Index*

217

**Introduction**

Any problem which is non-linear in character, which involves more than one coordinate system or more than one variable, or where structure is initially defined in the large, is likely to require considerations of topology and group theory for its solution. In the solution of such problems classical analysis will frequently appear as an instrument in the small, integrated over the whole problem with the aid of topology or group theory.

—M. Morse, *Calculus of Variations in the Large*, 1934

La possibilité d'utiliser le modèle différentiel est, à mes yeux, la justification ultime de l'emploi des modèles quantitatifs dans les sciences.

—R. Thom, *Stabilité Structurale et Morphogénèse*, 1972

In many branches of mathematics one finds spaces that can be described locally by  $n$ -tuples of real numbers. Such objects are called manifolds: a manifold is a topological space which is locally homeomorphic to Euclidean  $n$ -space  $\mathbb{R}^n$ . We can think of a manifold as being made of pieces of  $\mathbb{R}^n$  glued together by homeomorphisms. If these homeomorphisms are chosen to be differentiable, we obtain a *differentiable manifold*. This book is concerned mainly with differentiable manifolds.

**The Development of Differentiable Topology**

The concept of manifold emerged gradually from the geometry and function theory of the nineteenth century. Differential geometers studied curves and surfaces in "ordinary space"; they were mainly interested in local concepts such as curvature. Function theorists took a more global point of view: they realized that invariants of a function  $F$  of several real or complex variables could be obtained from topological invariants of the sets  $F^{-1}(c)$ ; for "most" values of  $c$ , these are manifolds.

Riemann broke new ground with the construction of what we call Riemann surfaces. These were perhaps the first abstract manifolds; that is, they were not defined as subsets of Euclidean space.

Riemann surfaces furnish a good example of how manifolds can be used to investigate global questions. The idea of a convergent power series (in one complex variable) is not difficult. This simple local concept becomes a complex global one, however, when the process of analytic continuation is introduced. The collection of all possible analytic continuations of a convergent power series has a global nature which is quite elusive. The global

aspect suddenly becomes clear as soon as Riemann surfaces are introduced: the continuations fit together to form a (single valued) function on a surface. *The surface expresses the global nature of the analytic continuation process.* The problem has become geometrized.

Riemann introduced the global invariant of the *connectivity* of a surface: this meant maximal number of curves whose union does not disconnect the surface, plus one. It was known and “proved” in the 1860’s that compact orientable surfaces were classified topologically by their connectivity. Strangely enough, no one in the nineteenth century saw the necessity for proving the subtle and difficult theorem that the connectivity of a compact surface is actually *finite*.

Poincaré began the topological analysis of 3-dimensional manifolds. In a series of papers on “Analysis Situs,” remarkable for their originality and power, he invented many of the basic tools of algebraic topology. He also bequeathed to us the most important unsolved problem in differential topology, known as *Poincaré’s conjecture*: is every simply connected compact 3-manifold, without boundary, homeomorphic to the 3-sphere?

It is interesting to note that Poincaré used purely differentiable methods at the beginning of his series of papers, but by the end he relied heavily on combinatorial techniques. For the next thirty years topologists concentrated almost exclusively on combinatorial and algebraic methods.

Although Herman Weyl had defined abstract differentiable manifolds in 1912 in his book on Riemann surfaces, it was not until Whitney’s papers of 1936 and later that the concept of differentiable manifold was firmly established as an important mathematical object, having its own problems and methods.

Since Whitney’s papers appeared, differential topology has undergone a rapid development. Many fruitful connections with algebraic and piecewise linear topology were found; good progress was made on such questions as embedding, immersions, and classification by homotopy equivalence or diffeomorphism. Poincaré’s conjecture is still unsolved, however. In recent years techniques and results from differential topology have become important in many other fields.

## The Nature of Differential Topology

In today’s mathematical sciences manifolds are found in many different fields. In algebra they occur as Lie groups; in relativity as space-time; in economics as indifference surfaces; in mechanics as phase-spaces and energy surfaces. Wherever dynamical processes are studied, (hydrodynamics, population genetics, electrical circuits, etc.) manifolds are used for the “state-space,” the setting for a model of the process by a differential equation or a mapping.

In most of these examples the historical development follows the *local-to-global* pattern. Lie groups, for example, were originally “local groups”

having a single parametrization as a neighborhood of the origin in  $\mathbb{R}^n$ . Only later did global questions arise, such as the classification of compact groups. In each case the global nature of the subject became geometrized (at least partially) by the introduction of manifolds. In mechanics, for example, the differences in the possible long-term behavior of two physical systems become clear if it is known that one energy surface is a sphere and the other is a torus.

When manifolds occur “naturally” in a branch of mathematics, there is always present some extra structure: a Riemannian metric, a binary operation, a dynamical system, a conformal structure, etc. It is often this structure which is the main object of interest; the manifold is merely the setting. But the differential topologist studies the manifold itself; the extra structures are used only as tools.

The extra structure often presents fascinating local questions. In a Riemannian manifold, for instance, the curvature may vary from point to point. *But in differential topology there are no local questions.* (More precisely, they belong to calculus.) A manifold looks exactly the same at all points because it is locally Euclidean. In fact, a manifold (connected, without boundary) is homogeneous in a more exact sense: its diffeomorphism group acts transitively.

The questions which differential topology tries to answer are global: they involve the whole manifold. Some typical questions are: Can a given manifold be embedded in another one? If two manifolds are homeomorphic, are they necessarily diffeomorphic? Which manifolds are boundaries of compact manifolds? Do the topological invariants of a manifold have any special properties? Does every manifold admit a non-trivial action of some cyclic group?

Each of these questions is, of course, a shorthand request for a *theory*. The embedding question, for example, really means: define and compute diffeomorphism invariants that enable us to decide whether  $M$  embeds in  $N$ , and in how many essentially distinct ways.

If we knew how to construct all possible manifolds and how to tell from “computable” invariants when two are diffeomorphic, we would be a long way toward answering any given question about manifolds. Unfortunately, such a classification theorem seems unattainable at present, except for very special classes of manifolds (such as surfaces). Therefore we must resort to more direct attacks on specific questions, devising different theories for different questions. Some of these theories, or parts of them, are presented in this book.

## The Contents of This Book

The first difficulty that confronts us in analyzing manifolds is their homogeneity. A manifold has no distinguished “parts”; every point looks like every other point. How can we break it down into simpler objects?

The solution is to artificially impose on a manifold a nonhomogeneous structure of some kind which can be analyzed. The major task then is to derive intrinsic properties of the original manifold from properties of the artificial structure.

This procedure is common in many parts of mathematics. In studying vector spaces, for example, one imposes coordinates by means of a basis; the cardinality of the basis is then proved to depend only on the vector space. In algebraic topology one defines the homology groups of a polyhedron in terms of a particular triangulation, and then proves the groups to be independent of the triangulation.

Manifolds are, in fact, often studied by means of triangulations. A more natural kind of decomposition, however, consists of the level sets  $f^{-1}(y)$  of a smooth map  $f: M \rightarrow \mathbb{R}$ , having the simplest kinds of critical points (where  $Df$  vanishes). This method of analysis goes back to Poincaré and even to Möbius (1866); it received extensive development by Marston Morse and today is called *Morse theory*. Chapter 6 is devoted to the elementary aspects of Morse theory. In Chapter 9 Morse theory is used to classify compact surfaces.

A basic idea in differential topology is that of *general position* or *transversality*; this is studied in Chapter 3. Two submanifolds  $A, B$  of a manifold  $N$  are in general position if at every point of  $A \cap B$  the tangent spaces of  $A$  and  $B$  span that of  $N$ . If  $A$  and  $B$  are not in general position, arbitrarily small perturbations of one of them will put them in general position. If they are in general position, they remain in it under all sufficiently small perturbations; and  $A \cap B$  is then a submanifold of the “right” dimension. A map  $f: M \rightarrow N$  is *transverse* to  $A$  if the graph of  $f$  and  $M \times A$  are in general position in  $M \times N$ . This makes  $f^{-1}(A)$  a submanifold of  $M$ , and the topology of  $f^{-1}(A)$  reflects many properties of  $f$ . In this way an important connection between manifolds and maps is established.

Transversality is a great unifying idea in differential topology; many results, including most of those in this book, are ultimately based on transversality in one form or another.

The theory of degrees of maps, developed in Chapter 5, is based on transversality in the following way. Let  $f: M \rightarrow N$  be a map between compact oriented manifolds of the same dimension, without boundary. Suppose  $f$  is transverse to a point  $y \in N$ ; such a point is called a regular value of  $f$ . The degree of  $f$  is the “algebraic” number of points in  $f^{-1}(y)$ , that is, the number of such points where  $f$  preserves orientation minus the number where  $f$  reverses orientation. It turns out that this degree is independent of  $y$  and, in fact, depends only on the homotopy class of  $f$ . If  $N = S^n$  then the degree is the *only* homotopy invariant. In this way we develop a bit of classical algebraic topology: the set of homotopy classes  $[M, S^n]$  is naturally isomorphic to the group of integers.

The theory of fibre bundles, especially vector bundles, is one of the

strongest links between algebraic and differential topology. Patterned on the tangent and normal bundles of a manifold, vector bundles are analogous to manifolds in form, but considerably simpler to analyze. Most of the deeper diffeomorphism invariants are invariants of the tangent bundle. In Chapter 4 we develop the elementary theory of vector bundles, including the classification theorem: isomorphism classes of vector bundles over  $M$  correspond naturally to homotopy classes of maps from  $M$  into a certain Grassmann manifold. This result relates homotopy theory to differential topology in a new and important way.

Further importance of vector bundles comes from the tubular neighborhood theorem: a submanifold  $B \subset M$  has an essentially unique neighborhood looking like a vector bundle over  $B$ .

In 1954 René Thom proposed the equivalence relation of *cobordism*: two manifolds are cobordant if together they form the boundary of a compact manifold. The resulting set of equivalence classes in each dimension has a natural abelian group structure. In a *tour de force* of differential and algebraic topology, Thom showed that these groups coincide with certain homotopy groups, and he carried out a good deal of their calculation. The elementary aspects of Thom’s theory, which is a beautiful mixture of transversality, tubular neighborhoods, and the classification of vector bundles, is presented in Chapter 7.

Of the remaining chapters, Chapter 1 introduces the basic definitions and, proves the “easy” Whitney embedding theorem: any map of a compact  $n$ -manifold into a  $(2n + 1)$ -manifold can be approximated by embeddings. Chapter 2 topologizes the set of maps from one manifold to another and develops approximation theorems. A key result is that for most purposes it can be assumed that every manifold is  $C^\infty$ . Much of this chapter can be skipped by a reader interested chiefly in compact  $C^\infty$  manifolds. Chapter 8 is a technical chapter on isotopy, containing some frequently used methods of deforming embeddings; these results are needed for the final chapter on the classification of surfaces.

The first three chapters are fundamental to everything else in the book. Most of Chapter 6 (Morse Theory) can be read immediately after Chapter 3; while Chapter 7 (Cobordism) can be read directly after Chapter 4. The classification of surfaces, Chapter 9, uses material from all the other chapters except Chapter 7.

The more challenging exercises are starred, as are those requiring algebraic topology or other advanced topics. The few that have two stars are really too difficult to be considered exercises, but are included for the sake of the results they contain. Three-star “exercises” are problems to which I do not know the answer.

A reference to Theorem 1 of Section 2 in Chapter 3 is written 3.2.1, or as 2.1 if it appears in Chapter 3. The section is called Section 3.2. Numbers in brackets refer to the bibliography.

### Acknowledgments

I am grateful to Alan Durfee for catching many errors; to Marnie McElhiney for careful typing; and to the National Science Foundation and the Miller Institute for financial support at various times while I was writing this book.

## Chapter 1

### Manifolds and Maps

Il faut d'abord examiner la question de la définition des variétés.

—P. Heegard, *Dissertation*, 1892

The assemblage of points on a surface is a twofold manifoldness; the assemblage of points in tri-dimensional space is a threefold manifoldness; the values of a continuous function of  $n$  arguments an  $n$ -fold manifoldness.

—G. Chrystal, *Encyclopedia Britannica*, 1892

The introduction of numbers as coordinates . . . is an act of violence . . .

—H. Weyl, *Philosophy of Mathematics and Natural Science*, 1949

Differential topology is the study of differentiable manifolds and maps. A manifold is a topological space which locally looks like Cartesian  $n$ -space  $\mathbb{R}^n$ ; it is built up of pieces of  $\mathbb{R}^n$  glued together by homeomorphisms. If these homeomorphisms are differentiable we obtain a differentiable manifold.

The task of differential topology is the discovery and analysis of global properties of manifolds. These properties are often quite subtle. In order to study them, or even to express them, a wide variety of topological, analytic and algebraic tools have been developed. Some of these will be examined in this book.

In this chapter the basic concepts of differential topology are introduced: differentiable manifolds, submanifolds and maps, and the tangent functor. This functor assigns to each differentiable manifold  $M$  another manifold  $TM$  called its tangent bundle, and to every differentiable map  $f: M \rightarrow N$  it assigns a map  $Tf: TM \rightarrow TN$ . In local coordinates  $Tf$  is essentially the derivative of  $f$ . Although its definition is necessarily rather complicated, the tangent functor is the key to many problems in differential topology; it reveals much of the deeper structure of manifolds.

In Section 1.3 we prove some basic theorems about submanifolds, maps and embeddings. The key ideas of regular value and transversality are introduced. The regular value theorem, which is just a global version of the implicit function theorem, is proved. It states that if  $f: M \rightarrow N$  is a map then under certain conditions  $f^{-1}(y)$  will be a submanifold of  $M$ . The submanifolds

$f^{-1}(y)$  and of the map  $f$  are intimately related; in this way a powerful positive feedback loop is created:

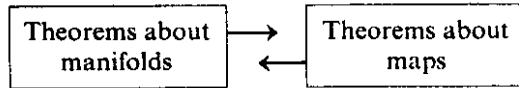

This interplay between manifolds and maps will be exploited in later chapters.

Also proved in Section 1.3 is the pleasant fact that every compact manifold embeds in some  $\mathbb{R}^q$ . Borrowing an analytic lemma from a later chapter, we then prove a version of the deeper embedding theorem of Whitney: every map of a compact  $n$ -manifold into  $\mathbb{R}^{2n+1}$  can be approximated by embeddings.

Manifolds with boundary, or  $\partial$ -manifolds, are introduced in Section 1.4. These form a natural and indeed indispensable extension of the manifolds defined in Section 1.1; their presence, however, tends to complicate the mathematics. The special arguments needed to handle  $\partial$ -manifolds are usually obvious; in order to present the main ideas without interruption we shall frequently postpone or omit entirely proofs of theorems about  $\partial$ -manifolds.

At the end of the chapter a convention is stated which is designed to exclude the pathology of non-Hausdorff and nonparacompact manifolds.

Running through the chapter is an idea that pervades all of differential topology: the passage from local to global. This theme is expressed in the very definition of manifold; every statement about manifolds necessarily repeats it, explicitly or implicitly. The proof of the regular value theorem, for example, consists in pointing out the local nature of the hypothesis and conclusion, and then applying the implicit function theorem (which is itself a passage from infinitesimal to local). The compact embedding theorem pieces together local embeddings to get a global one. Whitney's embedding theorem builds on this, using, in addition, a lemma on the existence of regular values. This proof of this lemma, as will be seen in Chapter 3, is a simple globalization of a rather subtle local property of differentiable maps.

Every concept in differential topology can be analyzed in terms of this local-global polarity. Often a definition, theorem or proof becomes clearer if its various local and global aspects are kept in mind.

## 0. Submanifolds of $\mathbb{R}^{n+k}$

Before giving formal definitions we first discuss informally the familiar space  $S^n$  and then more general submanifolds of Euclidean space.

The *unit  $n$ -sphere* is

$$S^n = \{x \in \mathbb{R}^{n+1} : |x| = 1\},$$

where  $|x| = \left(\sum_{i=1}^{n+1} x_i^2\right)^{1/2}$ . We introduce local coordinates in  $S^n$  as follows.

## 0. Submanifolds of $\mathbb{R}^{n+k}$

For  $j = 1, \dots, n+1$  define open hemispheres

$$U_{2j-1} = \{x \in S^n : x_j > 0\},$$

$$U_{2j} = \{x \in S^n : x_j < 0\}.$$

For  $i = 1, \dots, 2n+2$  define maps

$$\varphi_i : U_i \rightarrow \mathbb{R}^n,$$

$$\varphi_i(x) = (x_1, \dots, \hat{x}_j, \dots, x_{n+1}) \quad \text{if } i = 2j-1 \text{ or } 2j;$$

this means the  $n$ -tuple obtained from  $x$  by deleting the  $j$ th coordinate. Clearly  $\varphi_i$  maps  $U_i$  homeomorphically onto the open  $n$ -disk

$$B = \{y \in \mathbb{R}^n : |y| < 1\}.$$

It is easy to see that  $\varphi_i^{-1} : B \rightarrow \mathbb{R}^{n+1}$  is analytic.

Each  $(\varphi_i, U_i)$  is called a "chart" for  $S^n$ ; the set of all  $(\varphi_i, U_i)$  is an "atlas". In terms of this atlas we say a map  $f : S^n \rightarrow \mathbb{R}^k$  is "differentiable of class  $C^r$ " in case each composite map

$$f \circ \varphi_i^{-1} : B \rightarrow \mathbb{R}^k$$

is  $C^r$  i.e., has continuous partial derivatives of order  $r$ . If it happens that  $g : S^n \rightarrow \mathbb{R}^{m+1}$  is  $C^r$  in this sense, and  $g(S^n) \subset S^m$ , it is natural to call  $g : S^n \rightarrow S^m$  a  $C^r$  map. This definition is equivalent to the following. Let  $\{(\psi_j, V_j)\}$  be an atlas for  $S^m$ ,  $j = 1, \dots, q$ . Then  $g : S^n \rightarrow S^m$  is  $C^r$  provided each map

$$\psi_j \circ g \circ \varphi_i^{-1} : \varphi_i^{-1}(V_j) \rightarrow \mathbb{R}^m$$

is  $C^r$ ; this makes sense because  $\varphi_i^{-1}(V_j)$  is an open subset of  $\mathbb{R}^n$ .

Thus we have extended the notion of  $C^r$  map to the unit spheres  $S^n$ ,  $n = 1, 2, \dots$ . It is easy to verify that the composition of  $C^r$  maps (in this extended sense) is again  $C^r$ .

A larger class of manifolds is obtained as follows. Let  $f : \mathbb{R}^{n+k} \rightarrow \mathbb{R}^k$  be a  $C^r$  map,  $r \geq 1$ , and put  $M = f^{-1}(0)$ . Suppose that  $f$  has rank  $k$  at every point of  $f^{-1}(0)$ ; we call  $M$  a "regular level surface". An example is  $M = S^n \subset \mathbb{R}^{n+1}$  where  $f(x) = 1 - \sum_{i=1}^{n+1} x_i^2$ .

Local coordinates are introduced into  $M$  as follows. Fix  $p \in M$ . By a linear coordinate change we can assume that the  $k \times k$  matrix  $\partial f_i / \partial x_j$ ,  $1 \leq i, j \leq k$ , has rank  $k$  at  $p$ . Now identify  $\mathbb{R}^{n+k}$  with  $\mathbb{R}^n \times \mathbb{R}^k$  and put  $p = (a, b)$ . According to the implicit function theorem there exist a neighborhood  $U \times V$  of  $(a, b)$  in  $\mathbb{R}^n \times \mathbb{R}^k$  and a  $C^r$  map  $g : U \rightarrow V$ , such that  $g(x) = y$  if and only if  $f(x, y) = 0$ . Thus

$$M \cap (U \times V) = \{(x, g(x)) : x \in U\}$$

$$= \text{graph of } g.$$

Define

$$\begin{aligned} W &= M \cap (U \times V), \\ \varphi: W &\rightarrow \mathbb{R}^n, \\ (x, \varphi(x)) &\mapsto x \quad (x \in U). \end{aligned}$$

Then  $(\varphi, W)$  is taken as a local coordinate system on  $M$ . In terms of such coordinates we can further extend the notion of  $C^r$  map to maps between regular level surfaces.

Exactly the same constructions are made when the domain of  $f$  is taken to be an open subset of  $\mathbb{R}^{n+k}$ , rather than all of  $\mathbb{R}^{n+k}$ .

A significantly broader class of manifolds comprises those subsets  $M$  of  $\mathbb{R}^{n+k}$  which *locally* are regular level surfaces of  $C^r$  maps. That is, each point of  $M$  has a neighborhood  $W \subset \mathbb{R}^{n+k}$  such that

$$W \cap M = f^{-1}(0)$$

for some  $C^r$  map  $f: W \rightarrow \mathbb{R}^k$  having rank  $k$  at each point  $W \cap M$ . Local coordinates are introduced and  $C^r$  maps are defined as before. A manifold of this type is called an " $n$ -dimensional submanifold of  $\mathbb{R}^{n+k}$ ".

In each of these examples it is easy to see that *the coordinate changes are  $C^r$* . These coordinate changes are the maps

$$\varphi_j \varphi_i^{-1}: \varphi_i(U_i \cap U_j) \rightarrow \varphi_j(U_i \cap U_j)$$

where  $(\varphi_i, U_i)$  and  $(\varphi_j, U_j)$  vary over an atlas for the manifold in question. (The domain and range of  $\varphi_j \varphi_i^{-1}$  are open subsets of  $\mathbb{R}^n$ , so that it makes sense to say that  $\varphi_j \varphi_i^{-1}$  is  $C^r$ .)

This has an important implication: to verify that a map  $f: M \rightarrow N$  is  $C^r$ , it suffices to check that for each point  $x \in M$  there is at least one pair of charts,  $(\varphi, U)$  for  $M$  and  $(\psi, V)$  for  $N$ , with  $x \in U$  and  $f(U) \subset V$ , such that the map

$$\mathbb{R}^n \supset \varphi(U) \xrightarrow{\psi \circ \varphi^{-1}} \psi(V) \subset \mathbb{R}^n$$

is  $C^r$ . For suppose this is true, and let  $(\bar{\varphi}, \bar{U})$ ,  $(\bar{\psi}, \bar{V})$  be any charts for  $M$ ,  $N$ ; we must show that  $\bar{\psi} \bar{\varphi}^{-1}$  is  $C^r$ . An arbitrary point in the domain of  $\bar{\psi} \bar{\varphi}^{-1}$  is of the form  $\bar{\varphi}(x)$  where  $x \in \bar{U} \cap f^{-1}(\bar{V})$ . Let  $(\varphi, U)$ ,  $(\psi, V)$  be charts for  $M$ ,  $N$  such that  $x \in U$ ,  $f(U) \subset V$  and  $\psi \varphi^{-1}$  is  $C^r$ . Then in a neighborhood of  $\bar{\varphi}(x)$  we have

$$\bar{\psi} \bar{\varphi}^{-1} = (\bar{\psi} \psi^{-1})(\psi \varphi^{-1})(\varphi \bar{\varphi}^{-1}).$$

Thus  $\bar{\psi} \bar{\varphi}^{-1}$  is locally the composition of three  $C^r$  maps, so it is  $C^r$ .

Next we discuss the tangent bundle of an  $n$ -dimensional submanifold  $M \subset \mathbb{R}^{n+k}$ . Let  $x \in M$  and let  $(\varphi, U)$  be a chart at  $x$  (that is,  $x \in U$ ). Put  $a = \varphi(x) \in \mathbb{R}^n$ . Let  $E_x \subset \mathbb{R}^{n+k}$  be the vector subspace which is the range of the linear map

$$D\varphi_a^{-1}: \mathbb{R}^n \rightarrow \mathbb{R}^{n+k}.$$

Because of the chain rule,  $E_x$  depends only on  $x$ , not on the choice of  $(\varphi, U)$ .

The set  $x \times E_x = M_x$  is called the "tangent space" to  $M$  at  $x$ . We give it the natural vector space structure inherited from  $E_x$ . Notice that  $D\varphi_a^{-1}$  induces a vector space isomorphism between  $\mathbb{R}^n$  and  $M_x$ .

If we associate to every  $(x, y) \in M_x$  the point  $x + y \in \mathbb{R}^{n+k}$ , we obtain an embedding  $M_x \rightarrow \mathbb{R}^{n+k}$ . The image of this embedding is an affine  $n$ -plane in  $\mathbb{R}^{n+k}$  passing through  $x$ . It is tangent to  $M$  in the sense that it consists of all vectors based at  $x$  which are tangents to curves in  $M$  passing through  $x$ .

If  $f: M \rightarrow N$  is a  $C^r$  map (between submanifolds) and  $f(x) = z$ , a linear map  $Tf_x: M_x \rightarrow N_z$  is defined as follows. Let  $(\varphi, U)$ ,  $(\psi, V)$  be charts for  $M$ ,  $N$  at  $x$ ,  $z$ . Put  $\varphi(x) = a$ , and define  $Tf_x$  by

$$Tf_x: (x, y) \mapsto (z, D(\psi \varphi^{-1})_a y).$$

This is independent of the choice of  $(\varphi, U)$  and  $(\psi, V)$ , thanks to the chain rule.

The union of all the tangent spaces of  $M$  is called the "tangent bundle" of  $M$ . The linear maps  $Tf_x$  form a map  $Tf: TM \rightarrow TN$ . This map plays the role of a "derivative" of the map  $f: M \rightarrow N$ .

By means of  $Tf$  we can extend the notion of "rank" to maps between submanifolds: the rank of  $f$  at  $x \in M$  means the rank of the linear map  $Tf_x: M_x \rightarrow N_y$ .

The set  $TM$  is a subset of  $M \times \mathbb{R}^{n+k}$ , hence of  $\mathbb{R}^{n+k} \times \mathbb{R}^{n+k}$ . It is natural to ask whether  $TM$  is a submanifold. In fact, if  $(\varphi, U)$  is a chart for  $M$ , we obtain a natural chart  $(\Phi, TU)$  for  $TM$  by identifying

$$TU = \{(x, y) \in TM: x \in U\}$$

and defining

$$\begin{aligned} \Phi: TU &\rightarrow \mathbb{R}^n \times \mathbb{R}^n, \\ \Phi(x, y) &= (\varphi(x), (D\varphi_a^{-1})^{-1}y). \end{aligned}$$

These charts make  $TM$  into a  $C^{r-1}$  submanifold. The maps  $Tf$  are of class  $C^{r-1}$ .

This completes our sketch of the basic notions of *manifold*, *map* and *tangent bundle* for the special case of submanifolds of Euclidean space. We now proceed to abstract manifolds.

## 1. Differential Structures

A topological space  $M$  is called an  $n$ -dimensional *manifold* if it is locally homeomorphic to  $\mathbb{R}^n$ . That is, there is an open cover  $\mathcal{U} = \{U_i\}_{i \in A}$  of  $M$  such that for each  $i \in A$  there is a map  $\varphi_i: U_i \rightarrow \mathbb{R}^n$  which maps  $U_i$  homeomorphically onto an open subset of  $\mathbb{R}^n$ . We call  $(\varphi_i, U_i)$  a *chart* (or *coordinate system*) with domain  $U_i$ ; the set of charts  $\Phi = \{\varphi_i, U_i\}_{i \in A}$  is an *atlas*.

Two charts  $(\varphi_i, U_i)$ ,  $(\varphi_j, U_j)$  are said to have  $C^r$  *overlap* if the *coordinate change*

$$\varphi_j \varphi_i^{-1}: \varphi_i(U_i \cap U_j) \rightarrow \varphi_j(U_i \cap U_j)$$



is of differentiability class  $C^r$ , and  $\varphi_i\varphi_j^{-1}$  is also  $C^r$ . See Figure 1-1. Here  $r$  can be a natural number,  $\infty$ , or  $\omega$  (meaning real analytic). This definition makes sense because  $\varphi_i(U_i \cap U_j)$  and  $\varphi_j(U_i \cap U_j)$  are open sets in  $\mathbb{R}^n$ .

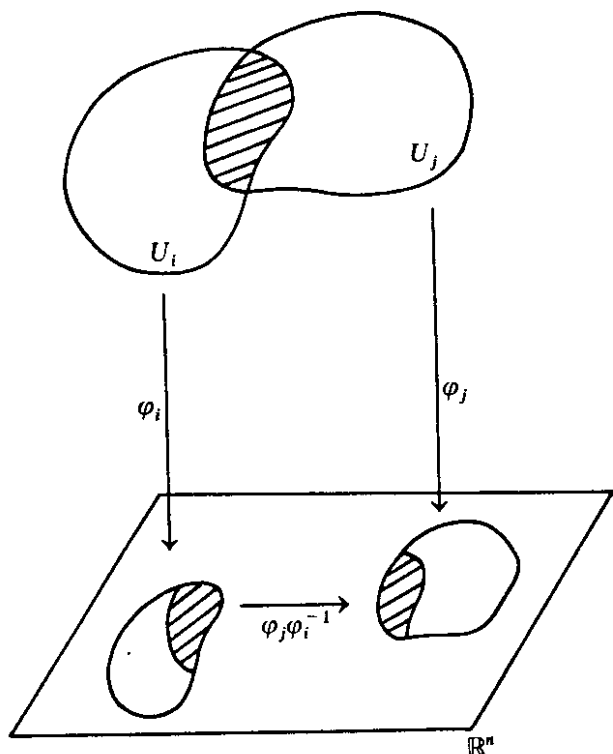

Figure 1-1. Overlapping charts.

An atlas  $\Phi$  on  $M$  is called  $C^r$  if every pair of its charts has  $C^r$  overlap. In this case there is a unique maximal  $C^r$  atlas  $\Psi$  which contains  $\Phi$ . In fact  $\Psi$  is the set of all charts which have  $C^r$  overlap with every chart in  $\Phi$ .

A maximal  $C^r$  atlas  $\alpha$  on  $M$  is a  $C^r$  differential structure; the pair  $(M, \alpha)$  is called a manifold of class  $C^r$ . A manifold of class  $\geq 1$  is called smooth.

To determine a  $C^r$  differential structure it suffices to give a single  $C^r$  atlas contained in it. Thus  $\mathbb{R}^n$  has a unique  $C^r$  differential structure containing the identity map of  $\mathbb{R}^n$ . More generally every open set  $U \subset \mathbb{R}^n$  has a unique  $C^r$  differential structure containing the inclusion map  $U \subset \mathbb{R}^n$ .

Suppose  $\alpha$  is a  $C^s$  differential structure on  $M$  and  $r$  is an integer such that  $1 \leq r < s$ . Since  $\alpha$  also a  $C^r$  atlas, it belongs to a unique  $C^r$  differential structure on  $M$ , obtained by adding to  $\alpha$  all charts having  $C^r$  overlap with every chart in  $\alpha$ . In this way every  $C^s$  manifold may be considered a  $C^r$  manifold. In Chapter 2 we shall prove the converse.

Let  $r$  be fixed until further notice; we omit the term " $C^r$ ."

If  $(M, \Phi)$  and  $(N, \Psi)$  are manifolds their Cartesian product is the manifold  $(M \times N, \Theta)$ , where  $\Theta$  is the differential structure containing all charts of the form

$$(\varphi \times \psi, U \times V); (\varphi, U) \in \Phi, (\psi, V) \in \Psi.$$

Here  $\varphi \times \psi$  maps  $U \times V$  into  $\mathbb{R}^m \times \mathbb{R}^n$ , which we identify with  $\mathbb{R}^{m+n}$ .

If  $(M, \Phi)$  is a manifold and  $W \subset M$  is an open set the induced differential structure on  $W$  is

$$\Phi|W = \{(\varphi, U) \in \Phi: U \subset W\}.$$

A differential structure  $\Phi$  on  $M$  is often obtained by the collation of differential structures  $\Phi_i$  on open sets  $U_i$  covering  $M$ . This means that

$$\Phi_i|U_i \cap U_j = \Phi_j|U_i \cap U_j \quad \text{for all } i, j$$

and  $\Phi$  is the unique differential structure on  $M$  containing each  $\Phi_i$  as a subset.

Let  $M$  be a topological space,  $(N, \Phi)$  a manifold and  $h: M \rightarrow N$  a homeomorphism of  $M$  onto an open subset of  $N$ . The induced differential structure on  $M$  is

$$h^*\Phi = \{(\varphi h, h^{-1}U): (\varphi, U) \in \Phi \quad \text{and} \quad U \subset h(M)\}.$$

The  $n$ -sphere  $S^n$  is given the  $C^\infty$  differential structure defined by the atlas given in the preceding section.

Real projective  $n$ -space  $P^n$  is the  $C^\infty$  manifold whose underlying space is the identification space of  $S^n$  under the antipodal map: we identify  $x \in S^n$  with  $-x$ . If  $p: S^n \rightarrow P^n$  is the natural projection,  $p$  maps each open hemisphere homeomorphically. Let  $\{U_1, \dots, U_k\}$  be a covering of  $S^n$  by open hemispheres. If we give each set  $p(U_i) = V_i$  the differential structure  $\Phi_i$  induced by  $(p|U_i)^{-1}$ , it is easy to see that  $\Phi_i$  and  $\Phi_j$  agree on  $V_i \cap V_j$ . Thus  $P^n$  is given a differential structure by collation.

More examples of manifolds are given in the exercises at the end of the section.

Some manifolds are contained in other manifolds in a natural way; thus  $S^n \subset \mathbb{R}^{n+1}$ . A subset  $A$  of a  $C^r$  manifold  $(M, \Phi)$  is a  $C^r$  submanifold of  $(M, \Phi)$  if for some integer  $k \geq 0$ , each point of  $A$  belongs to the domain of a chart  $(\varphi, U) \in \Phi$  such that

$$U \cap A = \varphi^{-1}(\mathbb{R}^k)$$

where  $\mathbb{R}^k \subset \mathbb{R}^n$  is the set of vectors whose last  $n - k$  coordinates are 0.<sup>1</sup> We call such a  $(\varphi, U)$  a submanifold chart for  $(M, A)$ . It is evident that if  $A$  is a submanifold of  $M$  then the maps

$$\varphi|U \cap A: U \cap A \rightarrow \mathbb{R}^k$$

form a  $C^r$  atlas for  $A$ , where  $(\varphi, U)$  varies over all submanifold charts. Thus  $A$  is a  $C^r$  manifold in its own right, of dimension  $k$ . The codimension of  $A$  is  $n - k$ .

<sup>1</sup> For  $r = 0$  this is sometimes called a locally flat  $C^0$  submanifold.

Let  $W \subset \mathbb{R}^n$  be an open set and  $f: W \rightarrow \mathbb{R}^r$  a  $C^r$  map,  $1 \leq r \leq \omega$ . Suppose  $y \in f(W)$  is a *regular value* of  $f$ ; this means that  $f$  has rank  $q$  at every point of  $f^{-1}(y)$ . (Therefore  $q \leq n$ .) Then the subset  $f^{-1}(y)$  is a  $C^r$  submanifold of  $\mathbb{R}^n$  of codimension  $q$ . This follows from the implicit function theorem, as explained in Section 1.0.

### Exercises

1. The *Grassmann manifold*  $G_{n,k}$  of  $k$ -dimensional linear subspaces or  $k$ -planes of  $\mathbb{R}^n$  is given an atlas as follows. Let  $E \subset \mathbb{R}^n$  be a  $k$ -plane and  $E^\perp$  its orthogonal complement. Identify  $\mathbb{R}^n$  with  $E \times E^\perp$ . Every  $k$ -plane near enough to  $E$  is the graph of a unique linear map  $E \rightarrow E^\perp$ . In this way a neighborhood of  $E \in G_{n,k}$  is mapped homeomorphically onto an open set in the vector space of linear maps  $E \rightarrow E^\perp$ . This makes  $G_{n,k}$  an analytic manifold of dimension  $k(n-k)$ .

2. *Complex projective  $n$ -space* is the manifold  $CP^n$  of (real) dimension  $2n$  obtained as follows. An element of  $CP^n$  is an equivalence class  $[z_0, \dots, z_n]$  of  $(n+1)$ -tuples of complex numbers not all 0. The equivalence relation is:  $[z_0, \dots, z_n] = [wz_0, \dots, wz_n]$  if  $w$  is a nonzero complex number. The topology is the natural quotient space topology. An atlas  $\{\varphi_i, U_i\}$ ,  $i = 0, \dots, n$  is defined as follows. Let  $U_i$  be the set of equivalence classes whose  $i$ 'th entry is nonzero. Map  $U_i$  into  $C^n$  by

$$[z_0, \dots, z_n] \rightarrow (z_0/z_i, \dots, \widehat{z_i/z_i}, \dots, z_n/z_i),$$

where  $\widehat{\phantom{x}}$  indicates deletion. Under the natural identification of complex  $n$ -space  $C^n$  with  $\mathbb{R}^{2n}$ , these maps form a  $C^\infty$  atlas on  $CP^n$ .

3. *Quaternionic projective  $n$ -space* is a  $4n$ -dimensional manifold constructed as in Exercise 2, using quaternions instead of complex numbers.

4. The group  $O(n)$  of orthogonal  $n \times n$  matrices is a compact submanifold of the vector space  $\mathbb{R}^{n^2}$  of all  $n \times n$  matrices; its dimension is  $\sum_{k=0}^{n-1} k$ . The component of the identity is the subgroup  $SO(n)$  of orthogonal matrices of determinant 1.

5. Let  $\Phi = \{\varphi_i, U_i\}_{i \in A}$  be an atlas on an  $n$ -dimensional manifold  $M$ . Put  $\varphi_i(U_i) = V_i \subset \mathbb{R}^n$ , and let  $X$  be the identification space obtained from  $\bigcup_{i \in A} V_i \times i$  when  $(x, i)$  is identified with  $(\varphi_i \varphi_j^{-1}(x), j)$ . Then  $X$  is homeomorphic to  $M$ .

6. If  $A$  is a submanifold of  $M$ , then  $A$  is a (relatively) closed submanifold of an open submanifold of  $M$ .

7. Let  $G_\lambda \subset \mathbb{R} \times \mathbb{R}$  be the graph of  $y = |x|^\lambda$ ,  $0 \leq \lambda < \infty$ . If  $r \in \mathbb{Z}$  and  $r < \lambda < r+1$  then  $G_\lambda$  is a submanifold which is  $C^r$  but not  $C^{r+1}$ . What if  $\lambda$  is an integer?

8. An *atlas of class  $C^r$*  on a set  $X$  is sometimes defined as a collection of bijective maps from subsets of  $X$  to open subsets of  $\mathbb{R}^n$  such that all coordinate changes are  $C^r$ . Given such an atlas  $\Phi$ , there is a unique topology on  $X$  making  $\Phi$  a  $C^r$  atlas (as defined in the text) on the space  $X$ .

9. Let  $C$  be the set of countable ordinal numbers. Let  $M = C \times [0, \infty) \setminus \{0, 0\}$ . Give  $M$  the total ordering

$$(\alpha, t) < (\alpha', t') \text{ if } \alpha < \alpha' \text{ or } \alpha = \alpha' \text{ and } t < t'.$$

Endow  $M$  with the order topology. Then  $M$  is a 1-manifold which is Hausdorff but not paracompact, called the *long line*.  $M$  has a  $C^\infty$  differential structure but no Riemannian metric. (See Koch and Puppe [1], Kneser and Kneser [1].)

10. Let  $L$  be the quotient space obtained from  $(\mathbb{R} \times 1) \cup (\mathbb{R} \times 0)$  by identifying  $(x, 1)$  with  $(x, 0)$  if  $x \neq 0$ . Then  $L$  is a non-Hausdorff 1-manifold, called the *line with two origins*. It has a  $C^\infty$  differential structure.

\*11. Let  $U \subset \mathbb{R}^2$  be a nonempty open set. Suppose given a  $C^r$  ( $r > 0$ ) vector field on  $U$  without zeros, such that each integral curve is closed in  $U$ . Let  $M$  be the identification space obtained by collapsing each integral curve to a point. Then  $M$  is a  $C^r$  1-manifold, which can be non-Hausdorff. [Hint: Use small intervals transverse to the integral curves to construct charts.]

\*\*12. A manifold is metrizable, and has a complete metric, if and only if it is paracompact and Hausdorff. A connected metrizable manifold has a countable base. But there is a connected separable Hausdorff 2-manifold which is not paracompact, (the double of  $M$  in Exercise 7, Section 4.6).

\*\*13. A paracompact manifold is an absolute neighborhood retract (see Hanner [1]).

## 2. Differentiable Maps and the Tangent Bundle

From now on we shall frequently suppress notation for the differential structure on a manifold  $M$ .

Let  $M$  and  $N$  be  $C^r$  manifolds and  $f: M \rightarrow N$  a map. A pair of charts  $(\varphi, U)$  for  $M$  and  $(\psi, V)$  for  $N$  is *adapted to  $f$*  if  $f(U) \subset V$ . In this case the map

$$\psi f \varphi^{-1}: \varphi(U) \rightarrow \psi(V)$$

is defined; we call it the *local representation* of  $f$  in the given charts, at the point  $x$  if  $x \in U$ .

The map  $f$  is called *differentiable* at  $x$  if it has a local representation at  $x$  which is differentiable. This definition makes sense since a local representation is a map between open sets in Cartesian spaces. Similarly,  $f$  is *differentiable of class  $C^r$*  if it has  $C^r$  local representations at all points.

If  $f$  is  $C^r$  then every local representation is  $C^r$ . To see this, let  $(\varphi, U)$  and  $(\psi, V)$  be a pair of charts adapted to  $f$ , and suppose  $f$  is  $C^r$ . To prove  $\psi f \varphi^{-1}$  is  $C^r$ , let  $y \in \varphi(V)$  be any point; put  $x = \varphi^{-1}(y)$ . Let  $(\varphi_0, U_0)$  and  $(\psi_0, V_0)$  be an adapted pair of charts giving  $f$  the  $C^r$  local representation  $\psi_0 f \varphi_0^{-1}$  at  $x$ . By replacing  $U_0$  and  $V_0$  by smaller open sets, if necessary, we can arrange that  $U_0 \subset U$  and  $V_0 \subset V$ . Then

$$\psi f \varphi^{-1} = (\psi \psi_0^{-1})(\psi_0 f \varphi_0^{-1})(\varphi_0 \varphi^{-1})$$

in  $\varphi(U_0)$ . The first and third maps on the right are  $C^r$  since they are coordinate changes. Hence  $\psi f \varphi^{-1}|_{\varphi(U_0)}$  is the composition of  $C^r$  maps and so is  $C^r$ . This proves that  $\psi f \varphi^{-1}$  is  $C^r$  in some neighborhood of every point, and so it is  $C^r$ .

Let  $f: M \rightarrow N$  and  $g: N \rightarrow P$  be  $C^r$  maps between  $C^r$  manifolds. It is easy to verify, using local representations, that the composition  $gf: M \rightarrow P$  is also  $C^r$ . The identity map and all constant maps are  $C^r$ . There is evidently a category of  $C^r$  manifolds and  $C^r$  maps.

An isomorphism in the  $C^r$  category is called a  $C^r$  diffeomorphism. (If  $r = 0$  this means a homeomorphism.) Explicitly, a  $C^r$  diffeomorphism  $f: M \rightarrow N$  is a  $C^r$  map between  $C^r$  manifolds  $M$  and  $N$  which is a homeomorphism, and whose inverse  $f^{-1}: N \rightarrow M$  is also of class  $C^r$ . If such a map exists we call  $M$  and  $N$   $C^r$  diffeomorphic manifolds and write  $M \approx N$ . This is the basic equivalence relation of differential topology.

Lest the reader lose heart at the prospect of an infinite sequence of equivalence relations, one for each  $r$ , we hasten to point out that there is no essential difference between  $C^r$  and  $C^s$  for  $1 \leq r < s \leq \infty$  (or even  $s = \omega$ , but that is much more difficult). In Chapter 3 we shall see that every  $C^r$  manifold is  $C^r$  diffeomorphic to a  $C^\omega$  manifold, and the latter is unique up to  $C^\omega$  diffeomorphism; and any  $C^r$  map can be approximated by  $C^\omega$  maps.

There is, however, an unbridgeable gap between  $C^0$  and  $C^1$ . In fact one of the most fascinating topics in differential topology began with the discoveries by Kervaire [1] and Smale [1] of compact manifolds having no differential structure whatever. (It is known that such a "nonsmoothable" manifold must have dimension at least 4; explicit examples are known in dimension 8.)

A basic task of differential topology is to find methods for deciding whether two given manifolds diffeomorphic. Of course diffeomorphic manifolds are homeomorphic, and have the same homotopy type. Therefore the diffeomorphism problem usually takes the form: what more do we need to know about two manifolds, in addition to their having the same homotopy type, to guarantee that they are diffeomorphic?

Often a differential invariant turns out to be a topological or homotopy type invariant. (The classic example is the sum of the indices of zeros of a vector field on a compact smooth manifold, which turns out to equal the Euler characteristic.) Such an invariant cannot distinguish between non-diffeomorphic manifolds which are homeomorphic. On the other hand, when a differential invariant is a homotopy invariant as well, it is easier to compute.

One of the most important differential invariants is the tangent bundle. In later chapters we will study the tangent bundle in some detail; here we merely give its definition (as a manifold) and the definition of the tangent of a map.

Let  $(M, \Phi)$  be a  $C^{r+1}$  manifold,  $0 \leq r \leq \omega$ , where  $\infty + 1 = \infty$  and  $\omega + 1 = \omega$ , with  $\Phi = \{\varphi_i, U_i\}_{i \in A}$ . Intuitively speaking, a "tangent vector" to  $M$  at  $x \in M$  is simply a vector in  $\mathbb{R}^n$  together with a chart which identifies each point near  $x$  with a point of  $\mathbb{R}^n$ .

A tangent vector should be an object independent of any particular chart, however, so we make the following definition. A *tangent vector* to  $M$  is an

equivalence class  $[x, i, a]$  of triples

$$(x, i, a) \in M \times A \times \mathbb{R}^n$$

under the equivalence relation:

$$[x, i, a] = [y, j, b]$$

if and only if  $x = y$  and

$$D(\varphi_j \varphi_i^{-1})(\varphi_i(x))a = b.$$

In other words, the derivative of the coordinate change at  $\varphi_i(x)$  sends  $a$  to  $b$ . That this is an equivalence relation follows from the rules for derivatives of compositions and inverses.

The set of all tangent vectors is  $TM$ , the *tangent bundle* of  $M$ . The map

$$p = p_M: TM \rightarrow M,$$

$$[x, i, a] \mapsto x$$

is well defined. For any subset  $A \subset M$  we put  $p^{-1}(A) = T_A M$ ; also  $p^{-1}(x) = M_x$  for  $x \in M$ . If  $U \subset M$  is open then  $(U, \Phi|_U)$  is also a  $C^{r+1}$  manifold, and we make the harmless identification  $T_U M = T U$ .

For any chart  $(\varphi_i, U_i) \in \Phi$  there is a well defined bijective map

$$T\varphi_i: T U_i \rightarrow \varphi_i(U_i) \times \mathbb{R}^n \subset \mathbb{R}^n \times \mathbb{R}^n,$$

$$[x, i, a] \mapsto (\varphi_i(x), a).$$

The map

$$(T\varphi_j)(T\varphi_i)^{-1}: \varphi_i(U_i \cap U_j) \times \mathbb{R}^n \rightarrow \varphi_j(U_i \cap U_j) \times \mathbb{R}^n$$

is the homeomorphism

$$(y, a) \mapsto (\varphi_j \varphi_i^{-1}(y), D(\varphi_j \varphi_i^{-1})(y)a).$$

It follows that  $TM$  has a topology making each  $T\varphi_i$  a homeomorphism, and this topology is unique. Moreover, since  $(T\varphi_j)(T\varphi_i)^{-1}$  is a  $C^r$  diffeomorphism, the set of charts  $\{T\varphi_i, T U_i\}_{i \in A}$  is a  $C^r$  atlas on  $TM$ . In this way  $TM$  is a  $C^r$  manifold. The projection map  $p: TM \rightarrow M$  is  $C^r$ . The charts  $(T\varphi_i, T U_i)$  are called *natural charts* on  $TM$ .

Let  $x \in U_i$ . The map  $T\varphi_{ix}: M_x \rightarrow \mathbb{R}^n$ , defined as the composition

$$M_x \subset T U_i \xrightarrow{T\varphi_i} \varphi_i(U_i) \times \mathbb{R}^n \rightarrow \mathbb{R}^n,$$

is a bijection; hence it induces an  $n$ -dimensional vector space structure on  $M_x$ . This structure is independent of  $i$ , since if  $x \in U_j$ ,

$$(T\varphi_{jx})(T\varphi_{ix})^{-1} = D(\varphi_j \varphi_i^{-1})(\varphi_i(x))$$

which is a linear automorphism of  $\mathbb{R}^n$ . In this way  $M_x$  becomes a vector space, the *tangent space to  $M$  at  $x$* . Thus  $TM$  is the disjoint union of the vector spaces  $M_x$ . It is a bundle of vector spaces, or "vector bundle." This aspect of  $TM$  will be emphasized in later chapters.

The simplest kind of tangent bundle is that of an open set  $W \subset \mathbb{R}^q$ . In this case we identify  $TW$  with  $W \times \mathbb{R}^q$  via the inclusion chart  $\varphi: W \rightarrow \mathbb{R}^q$  and the corresponding natural chart on  $TW$ . The projection  $TW \rightarrow W$  is just the natural projection  $W \times \mathbb{R}^q \rightarrow W$ . If  $M$  is a submanifold of  $\mathbb{R}^3$  we can think of tangent vectors to  $M$  as arrows and  $M_x$  as a plane, as in Figure 1-2.

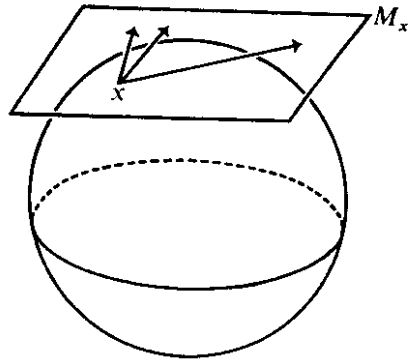

Figure 1-2. Tangent vectors to  $M = S^2 \subset \mathbb{R}^3$ .

Let  $f: M \rightarrow N$  be a  $C^{r+1}$  map,  $0 \leq r \leq \omega$ . A  $C^r$  map  $Tf: TM \rightarrow TN$  is defined as follows: a local representation of  $Tf$  in natural charts on  $TM$  and  $TN$  is the derivative of the corresponding local representation of  $f$ . More explicitly, let  $\varphi_i: U_i \rightarrow \mathbb{R}^m$ ,  $\psi_j: V_j \rightarrow \mathbb{R}^n$  be charts for  $M, N$  with  $f(U_i) \subset V_j$ . An application of the chain rule shows that the  $C^r$  map

$$(Tf)_{ij}: TU_i \rightarrow TV_j, \\ [x, i, a] \mapsto [f(x), j, D(\psi_j f \varphi_i^{-1})(\varphi_i(x))a]$$

is independent of  $i, j$ . Thus there is a well defined map  $Tf: TM \rightarrow TN$  which coincides with  $(Tf)_{ij}$  on  $TU_i$ .

If  $f(x) = y$  then  $Tf$  maps  $M_x$  into  $N_y$ , and the restriction of  $Tf$  is a linear map:  $T_x f: M_x \rightarrow N_y$ .

In the natural charts this is just the derivative at  $x$  of the corresponding local representation of  $f$ . Thus  $T_x f$  may be thought of as the derivative of  $f$  at  $x$ . Note, however, that its domain and range depend on  $x$ .

Using natural charts one sees that the diagram

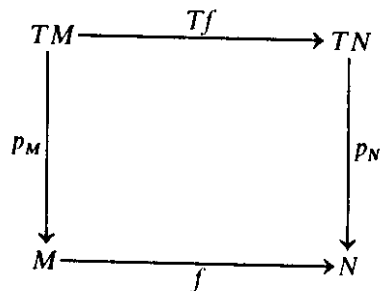

is commutative, that is,  $f \circ p_M = p_N \circ Tf$ . Likewise, if  $f: M \rightarrow N$  and  $g: N \rightarrow Q$  are  $C^{r+1}$  maps then the diagram

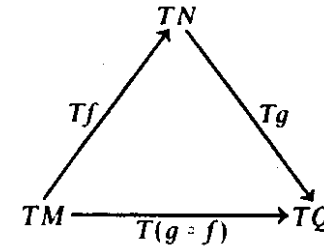

commutes; in other words

$$T(g \circ f) = (Tg) \circ (Tf).$$

And clearly

$$T 1_M = 1_{TM}.$$

(The identity map of any space  $S$  is denoted by  $1_S$ .) These last two properties may be summarized by saying that the assignments  $M \mapsto TM$ ,  $f \mapsto Tf$  define a covariant functor  $T$  from the category of  $C^{r+1}$  manifolds to the category of  $C^r$  manifolds.

If  $M \subset N$  is a  $C^{r+1}$  submanifold,  $r \geq 0$ , let  $j: M \rightarrow N$  be the inclusion map. Then  $Tj: TM \rightarrow TN$  is a  $C^r$  embedding and the image of  $TM$  is a  $C^r$  submanifold of  $TN$ ; this is seen by using natural charts derived from submanifold charts. Thus we identify  $TM$  with a  $C^r$  submanifold of  $TN$ .

In the special case  $M \subset \mathbb{R}^q$ ,  $TM$  is a submanifold of  $T\mathbb{R}^q = \mathbb{R}^q \times \mathbb{R}^q$ . A tangent vector to  $M$  is sometimes defined as an equivalence class of  $C^1$  maps  $f: [0, a) \rightarrow M$ , where  $f$  is equivalent to  $g: [0, b) \rightarrow M$  if  $f(0) = g(0)$  and for some (and hence any) chart  $(\varphi_i, U_i)$  at  $f(0)$ .

$$D(\varphi_i f)(0) = D(\varphi_i g)(0).$$

To such an equivalence class we associate the tangent vector (as defined previously)

$$[f(0), i, D(\varphi_i f)(0)].$$

Conversely, to a tangent vector  $[x, i, a]$  we associate the equivalence class of the  $C^1$  map

$$f: [0, a) \rightarrow M, \\ f(t) = \varphi_i^{-1}(\varphi_i(x) + ta),$$

which is defined for sufficiently small  $a > 0$ .

These processes are inverse to each other; the two definitions of tangent vector are equivalent. But the first definition works better for manifolds with boundary.

We introduce two special notations which extend standard usage from calculus. If  $J \subset \mathbb{R}$  is an interval and  $f: J \rightarrow M$  is a  $C^1$  map, for each  $x \in J$

we denote by  $f'(x)$  the image under  $Tf$  of the tangent vector

$$(x, 1) \in T_x J = J \times \mathbb{R}.$$

If  $U \subset \mathbb{R}^n$  is open and  $f: M \rightarrow U$  is  $C^1$ , for each  $x \in M$  we define the linear map

$$Df_x = Df(x): M_x \rightarrow \mathbb{R}^n$$

to be the composition

$$M_x \xrightarrow{Tf} TU = U \times \mathbb{R}^n \rightarrow \mathbb{R}^n.$$

### Exercises

- Let  $M, N$  be  $C^r$  manifolds. A map  $f: M \rightarrow N$  is  $C^r$  if and only if  $f \circ g: W \rightarrow N$  is  $C^r$  for every  $C^r$  map  $g: W \rightarrow M$  where  $W$  is open in some Euclidean space.
- Let  $M$  be a  $C^r$  manifold,  $r \geq 1$ , and  $A \subset M$  a connected subset. Suppose that there is a  $C^r$  retraction  $f: M \rightarrow A$ , i.e.  $f|_A = \text{identity}$ . Then  $A$  is a  $C^r$  submanifold. (A converse is proved in Chapter 4.) [Hint:  $f$  has constant rank near  $A$ .]
- Let  $A, M_1, M_2$  be  $C^r$  manifolds. A map  $f: A \rightarrow M_1 \times M_2$ ,  $f(x) = (f_1(x), f_2(x))$  is  $C^r$  if and only if each map  $f_i: A \rightarrow M_i$  is  $C^r$ .
- The map  $G_{n,k} \rightarrow G_{n,n-k}$ ,  $E \mapsto E^\perp$  (Exercise 1, Section 1.1) is a  $C^\infty$  diffeomorphism.
- Let  $f: \mathbb{R}^n \rightarrow \mathbb{R}^k$  be any continuous map. There exists a  $C^\infty$  differential structure  $\phi$  on  $\mathbb{R}^n \times \mathbb{R}^k$  such that the map

$$g: \mathbb{R}^n \rightarrow (\mathbb{R}^n \times \mathbb{R}^k, \phi), \\ x \mapsto (x, f(x)),$$

is a  $C^\infty$  embedding.

- A connected, paracompact Hausdorff 1-manifold is diffeomorphic to the circle if it is compact, and to the line if it is not compact.
- Let  $Q$  be a positive definite quadratic form on  $\mathbb{R}^n$ . Then  $Q^{-1}(y)$  is diffeomorphic to  $S^{n-1}$  for all  $y > 0$ .
- Every nonempty starshaped open subset of  $\mathbb{R}^n$  is  $C^\infty$  diffeomorphic to  $\mathbb{R}^n$ . ( $M \subset \mathbb{R}^n$  is *starshaped* about some  $x \in \mathbb{R}^n$  if it contains the entire closed interval in  $\mathbb{R}^n$  from  $x$  to each point of  $M$ .)
- A  $C^r$  map which is a  $C^1$  diffeomorphism is a  $C^r$  diffeomorphism.
- (a) The manifold  $G_{3,2}$  of 2-dimensional subspaces of  $\mathbb{R}^3$  is diffeomorphic to real projective 2-space  $P^2$ .  
 \*(b)  $SO(3) \approx P^3$ .  
 \*(c) The manifold of oriented 2-dimensional subspaces of  $\mathbb{R}^4$  (supply the definition) is diffeomorphic to  $S^2 \times S^2$ .

\*11. A subset of  $\mathbb{R}^2$  which is homeomorphic to  $S^1$  is a  $C^0$  submanifold. (This requires Schoenflies' theorem.)

12. For each  $n \geq 0$  there is a diffeomorphism

$$(TS^n) \times \mathbb{R} \approx S^n \times \mathbb{R}^{n+1}.$$

[Hint: there are natural isomorphisms  $T_x S^n \oplus \mathbb{R} \approx \mathbb{R}^{n+1}$ .]

13. There is a natural diffeomorphism

$$T(M \times N) \approx TM \times TN.$$

14. Let  $G \subset \mathbb{R} \times \mathbb{R}$  be the graph of  $y = |x|^{1/3}$ . Then  $G$  has a  $C^\infty$  differential structure making the inclusion  $G \rightarrow \mathbb{R} \times \mathbb{R}$  a  $C^\infty$  map.

\*\*15. (M. Brown [1]) Let  $M$  be an  $n$ -manifold of the form  $\bigcup_{k=1}^{\infty} M_k$ , where each  $M_k \approx \mathbb{R}^n$  and  $M_k \subset M_{k+1}$ . Then  $M \approx \mathbb{R}^n$ .

## 3. Embeddings and Immersions

Let  $f: M \rightarrow N$  be a  $C^1$  map (where  $M$  and  $N$  are  $C^r$  manifolds,  $r \geq 1$ ). We call  $f$  *immersive* at  $x \in M$  if the linear map  $T_x f: M_x \rightarrow N_{f(x)}$  is injective, and *submersive* if  $T_x f$  is surjective. If  $f$  is immersive at every point of  $M$  it is an *immersion*; if it is submersive at every point,  $f$  is a *submersion*.

We call  $f: M \rightarrow N$  an *embedding* if  $f$  is an immersion which  $f$  maps  $M$  homeomorphically onto its image. To indicate this we may write  $f: M \hookrightarrow N$ .

**3.1. Theorem.** Let  $N$  be a  $C^r$  manifold,  $r \geq 1$ . A subset  $A \subset N$  is a  $C^r$  submanifold if and only if  $A$  is the image of a  $C^r$  embedding.

*Proof.* Suppose  $A$  is a  $C^r$  submanifold. Then  $A$  has a natural  $C^r$  differential structure derived from a covering by submanifold charts. For this differential structure the inclusion of  $A$  in  $N$  is a  $C^r$  embedding.

Conversely, suppose  $f: M \hookrightarrow N$  is a  $C^r$  embedding.  $f(M) = A$ . The property of being a  $C^r$  submanifold has *local character*, that is it is true of  $A \subset N$  if and only if it is true of  $A_i \subset N_i$  where  $\{A_i\}$  is an open cover of  $A$  and each  $N_i$  is an open subset of  $N$  containing  $A_i$ . It is also *invariant under  $C^r$  diffeomorphisms*, that is,  $A \subset N$  is a  $C^r$  submanifold if and only if  $g(A) \subset N'$  is a  $C^r$  submanifold where  $g: N \rightarrow N'$  is a  $C^r$  diffeomorphism (or even a  $C^r$  embedding).

To exploit local character and invariance under diffeomorphism, let  $\Psi = \{\psi_i: N_i \rightarrow \mathbb{R}^n\}_{i \in I}$  be a family of charts on  $N$  which covers  $A$ . Then find an atlas  $\Phi = \{\varphi_i: M_i \rightarrow \mathbb{R}^m\}_{i \in I}$  for  $M$  such that  $f(M_i) \subset N_i$  (re-indexing  $\Psi$  if necessary). Since  $f$  is an embedding,  $\Phi$  and  $\Psi$  can be chosen so that  $f(M_i) = A \cap N_i$ . By invariance it is enough to show that  $\psi_i f(M_i) \subset \mathbb{R}^n$  is a  $C^r$  submanifold. Put

$$U_i = \varphi_i(M_i) \subset \mathbb{R}^m, \\ f_i = \psi_i f \varphi_i^{-1}: U_i \rightarrow \mathbb{R}^n.$$

Then  $f_i$  is a  $C^r$  embedding and  $f_i(U_i) = \psi_i f(M_i)$ . Thus we have reduced the theorem to the special case where  $N = \mathbb{R}^n$ ,  $M$  is an open set  $U \subset \mathbb{R}^m$ , and  $f: U \hookrightarrow \mathbb{R}^n$  is a  $C^r$  embedding. In this case a corollary of the inverse function theorem implies that there is a  $C^r$  submanifold chart for  $(\mathbb{R}^n, f(U))$  at each point of  $f(U)$ .

QED

The theorem just proved exhibits the interplay between *local* and *global*. The statement of the theorem asserts that an object defined by local properties—a submanifold—is the same as an object defined in global terms, namely the image of an embedding. The first part of the proof just collates the local submanifold charts (restricted to  $A$ ) into a differential structure on  $A$ ; this makes the inclusion map of  $A$  into an embedding.

In the second part of the proof a new idea appears: the passage from *infinitesimal* to *local*. The condition that  $f: M \rightarrow N$  be an immersion is an “infinitesimal” condition in that it refers only to the limiting behavior of  $f$  at each point. The inverse function theorem is a link between an infinitesimal condition and a local condition (by which we mean a statement about the behavior of  $f$  on whole neighborhoods of points).

Before stating the next theorem we make some important definitions. Let  $f: M \rightarrow N$  be a  $C^1$  map. We call  $x \in M$  a *regular point* if  $f$  is submersive at  $x$ ; otherwise  $x$  is a *critical point* and  $f(x)$  is a *critical value*. If  $y \in N$  is not a critical value it is called a *regular value*, even if  $y$  is not in  $f(M)$ .<sup>2</sup> If  $y \in f(M)$  is a regular value,  $f^{-1}(y)$  is called a *regular level surface*.

The following *regular value theorem* is often used to define manifolds.

**3.2. Theorem.** *Let  $f: M \rightarrow N$  be a  $C^r$  map,  $r \geq 1$ . If  $y \in f(M)$  is a regular value then  $f^{-1}(y)$  is a  $C^r$  submanifold of  $M$ .*

*Proof.* By using local character and invariance, as in the proof of Theorem 3.1, we reduce the theorem to the case where  $M$  is an open set in  $\mathbb{R}^m$  and  $N = \mathbb{R}^n$ . Again the theorem follows from the inverse function theorem.

QED

Theorems 3.2 and 3.1 are somewhat dual to each other under the vague dualities *immersion-submersion* and *kernel-image*, regarding  $f^{-1}(y)$  as a “kernel” of  $f$ . The duality is flawed because in Theorem 3.2 the implication is only in one direction. In fact, it is not true that every submanifold is the inverse image of a regular value; see Exercise 11.

An important extension of the last result concerns a map  $f: M \rightarrow N$  which is *transverse* to a submanifold  $A \subset N$ . This means that whenever  $f(x) = y \in A$ , then

$$A_y + T_x f(M_x) = N_y;$$

that is, the tangent space to  $N$  at  $y$  is spanned by the tangent space to  $A$  at  $y$  and the image of the tangent space to  $M$  at  $x$ .

**3.3. Theorem.** *Let  $f: M \rightarrow N$  be a  $C^r$  map,  $r \geq 1$  and  $A \subset N$  a  $C^r$  submanifold. If  $f$  is transverse to  $A$  then  $f^{-1}(A)$  is a  $C^r$  submanifold of  $M$ . The codimension of  $f^{-1}(A)$  in  $M$  is the same as the codimension of  $A$  in  $N$ .*

<sup>2</sup> This is in accordance with the principle that in mathematics a *red herring* does not have to be either red or a herring.

*Proof.* It suffices to prove the theorem locally. Therefore we replace the pair  $(N, A)$  by  $(U \times V, U \times 0)$  where  $U \times V \subset \mathbb{R}^p \times \mathbb{R}^q$  is an open neighborhood of  $(0, 0)$ . It is easy to see that the map  $f: M \rightarrow U \times V$  is transverse to  $U \times 0$  if and only if the composite map

$$g: M \xrightarrow{f} U \times V \xrightarrow{\pi} V$$

has 0 for a regular value (Figure 1-3). Since  $f^{-1}(U \times 0) = g^{-1}(0)$  the theorem follows from Theorem 3.2.

QED

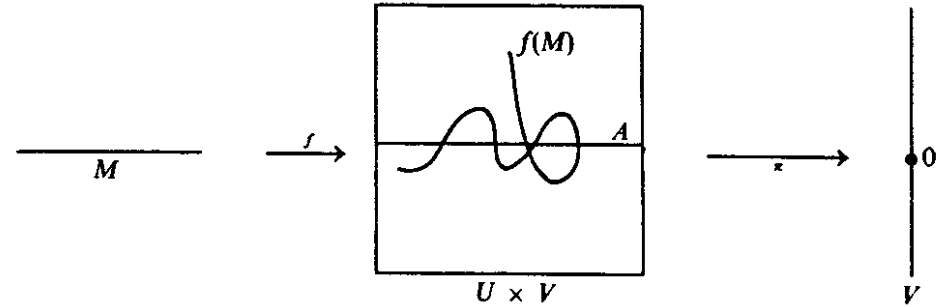

Figure 1-3.  $\pi f = g$ .

We shall see in the Chapter 3 that any map can be approximated by maps transverse to a given submanifold.

The next result makes the abstract notion of manifold somewhat more concrete.

**3.4. Theorem.** *Let  $M$  be a compact Hausdorff manifold of class  $C^r$ ,  $1 \leq r \leq \infty$ . Then there exists a  $C^r$  embedding of  $M$  into  $\mathbb{R}^q$  for some  $q$ .*

*Proof.* Let  $n = \dim M$  be the dimension of  $M$ . Let  $D^r(\rho) \subset \mathbb{R}^n$  denote the closed disk of radius  $\rho$  and center 0.<sup>3</sup> Since  $M$  is compact it has a finite atlas, and one easily finds an atlas  $\{\varphi_i, U_i\}_{i=1}^m$  having the following two properties: for all  $i$

$$\varphi_i(U_i) \supset D^r(2),$$

and

$$M = \bigcup \text{Int } \varphi_i^{-1}(D^r(1)).$$

Let  $\lambda: \mathbb{R}^n \rightarrow [0, 1]$  be a  $C^\infty$  map equal to 1 on  $D^r(1)$  and 0 on  $\mathbb{R}^n - D^r(2)$ . (Such a map is constructed in Section 2.2.) Define  $C^r$  maps

$$\lambda_i: M \rightarrow [0, 1],$$

$$\lambda_i = \begin{cases} \lambda \circ \varphi_i & \text{on } U_i \\ 0 & \text{on } M - U_i \end{cases}$$

<sup>3</sup> This means that  $D^r(\rho) = \{x \in \mathbb{R}^n: |x| \leq \rho\}$ ; the *unit disk* is  $D^r = D^r(1)$ .

It follows that the sets

$$B_i = \lambda_i^{-1}(1) \subset U_i$$

cover  $M$ .

Define maps

$$f_i: M \rightarrow \mathbb{R}^n,$$

$$f_i(x) = \begin{cases} \lambda_i(x)\varphi_i(x) & \text{if } x \in U_i \\ 0 & \text{if } x \in M - U_i \end{cases}$$

Put

$$g_i = (f_i, \lambda_i): M \rightarrow \mathbb{R}^n \times \mathbb{R} = \mathbb{R}^{n+1},$$

and

$$g = (g_1, \dots, g_m): M \rightarrow \mathbb{R}^{n+1} \times \dots \times \mathbb{R}^{n+1} = \mathbb{R}^{m(n+1)}.$$

Clearly  $g$  is  $C^r$ . If  $x \in B_i$  then  $g_i$ , and hence  $g$ , is immersive at  $x$ , so  $g$  is an immersion. To see that  $g$  is injective, suppose  $x \neq y$  with  $y \in B_i$ . If  $x \in B_i$  then  $g(x) \neq g(y)$  since  $f_i|_{B_i} = \varphi_i|_{B_i}$ . If  $x \notin B_i$  then  $\lambda_i(y) = 1 \neq \lambda_i(x)$ , so  $g(x) \neq g(y)$ . Therefore  $g$  is an injective  $C^r$  immersion. Since  $M$  is compact  $g$  is an embedding.

QED

The preceding proof follows a globalization pattern that is typical in differential topology: a global construction (the embedding) is made by piecing together local objects (the charts  $\varphi_i$ ). In this case the local embedding is implicit in the definition of manifold, but often the local construction is the more difficult part.

In most problems one runs into an "obstruction" to globalizing. If that happens, a successful theory consists of first formalizing the obstruction as a number, or other algebraic object, and then relating it to other invariants. We shall see many examples of this process.

The rest of this section is devoted to the following sharpening of Theorem 3.4, known as the "easy Whitney embedding theorem":

**3.5. Theorem.** *Let  $M$  be a compact Hausdorff  $C^r$   $n$ -dimensional manifold,  $2 \leq r \leq \infty$ . Then there is a  $C^r$  embedding of  $M$  in  $\mathbb{R}^{2n+1}$ .*

*Proof.* By Theorem 3.4,  $M$  embeds in some  $\mathbb{R}^q$ . If  $q \leq 2n + 1$  there is nothing more to prove; hence we assume  $q > 2n + 1$ . We may replace  $M$  by its image under an embedding. Therefore we assume that  $M$  is a  $C^r$  submanifold of  $\mathbb{R}^q$ . It is sufficient to prove that such an  $M$  embeds in  $\mathbb{R}^{2n+1}$ , for repetition of the argument will eventually embed  $M$  in  $\mathbb{R}^{2n+1}$ .

Suppose then that  $M \subset \mathbb{R}^q, q > 2n + 1$ . Identify  $\mathbb{R}^{q-1}$  with  $\{x \in \mathbb{R}^q: x_q = 0\}$ . If  $v \in \mathbb{R}^q - \mathbb{R}^{q-1}$  denote by  $f_v: \mathbb{R}^q \rightarrow \mathbb{R}^{q-1}$  the projection parallel to  $v$ . We seek a vector  $v$  such that

$$f_v|_M: M \rightarrow \mathbb{R}^{q-1}$$

is a  $C^r$  embedding. See Figure 1-4. We limit our search to unit vectors.

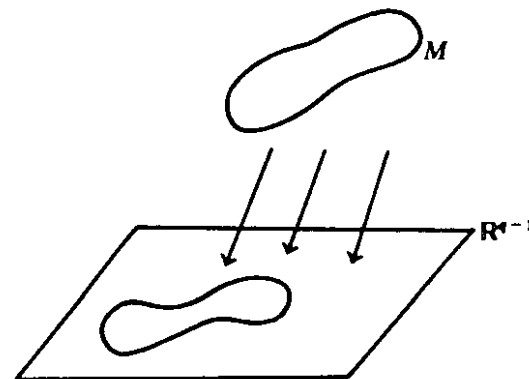

Figure 1-4. Projecting  $M \subset \mathbb{R}^q$  into  $\mathbb{R}^{q-1}$ .

What does this require of  $v$ ? For  $f_v|_M$  to be injective means that  $v$  is not parallel to any secant of  $M$ . That is, if  $x, y$  are any two distinct points of  $M$ , then

$$(1) \quad v \neq \frac{x - y}{|x - y|}.$$

More subtle is the requirement that  $f_v|_M$  be an immersion. The kernel of the linear map  $f_v$  is obviously the line through  $v$ . Therefore a tangent vector  $z \in T_x M$  is in the kernel of  $T_x f_v$  only if  $z$  is parallel to  $v$ . We can guarantee that  $f_v|_M$  is an immersion by requiring, for all nonzero  $z \in TM$ :

$$(2) \quad v \neq \frac{z}{|z|}$$

Here  $z$  is identified with a vector in  $\mathbb{R}^q$  as explained in Section 1.2; thus  $|z|$  makes sense.

Condition (1) is analyzed by means of the map

$$\sigma: M \times M - \Delta \rightarrow S^{q-1},$$

$$\sigma(x, y) = \frac{x - y}{|x - y|}$$

where  $\Delta$  (or  $M_\Delta$ ) is the diagonal:

$$\Delta = \{(a, b) \in M \times M: a = b\}.$$

Clearly  $v$  satisfies (1) if and only if  $v$  is not in the image of  $\sigma$ . We consider  $M \times M - \Delta$  as an open submanifold of  $M \times M$ ; the map  $\sigma$  is then  $C^r$ . Note that

$$\dim(M \times M - \Delta) = 2n < \dim S^{q-1}.$$

The existence of a  $v$  satisfying (1) follows from the following result:

**Lemma.** *Let  $g: P \rightarrow Q$  be a  $C^1$  map. If  $\dim Q > \dim P$  then the complement of the image of  $g$  is dense in  $Q$ .*

The proof of the lemma, which involves a different set of ideas, is postponed to Chapter 3. In the case at hand  $P = M \times M - \Delta$  and  $Q = S^{q-1}$ . Assuming the lemma, we know that every nonvoid open subset of  $S^{q-1}$  contains a point  $v$  which is not in the image of  $\sigma$ .

To analyze condition (2) we note that it holds for all  $z \in TM$  provided it holds whenever  $|z| = 1$ . Let

$$T_1M = \{z \in TM : |z| = 1\}.$$

This is the *unit tangent bundle* of  $M$ . It is a  $C^{r-1}$  submanifold of  $TM$ . To see this, observe that

$$T_1M = v^{-1}(1)$$

where

$$v: TM \rightarrow \mathbb{R},$$

$$v(z) = |z|^2.$$

Since  $v$  is the restriction to  $TM$  of the  $C^\omega$  map

$$T\mathbb{R}^q \rightarrow \mathbb{R},$$

$$z \mapsto |z|^2,$$

it is  $C^{r-1}$ . It is clear that 1 is a regular value for  $v$ ; for if  $v(z) = 1$  then

$$\left. \frac{d}{dt} v(tz) \right|_{t=1} \neq 0.$$

Hence  $v^{-1}(1)$  is a  $C^{r-1}$  submanifold by Theorem 3.2. It is easy to see that it is compact because  $M$  is compact.

Define a  $C^{r-1}$  map  $\tau: T_1M \rightarrow S^{q-1}$  as follows. Identify  $TM$  with a subset of  $M \times \mathbb{R}^q$ ; then  $T_1M$  is a subset of  $M \times S^{q-1}$ . Define  $\tau$  to be the restriction to  $T_1M$  of the projection onto  $S^{q-1}$ . Geometrically  $\tau$  is just parallel translation of unit vectors based at points of  $M$  to unit vectors based at 0.

Clearly  $\tau$  is  $C^{r-1}$ . Noting that

$$\dim T_1M = 2n - 1 < \dim S^{q-1},$$

we apply the lemma to conclude that the image of  $\tau$  is nowhere dense. Since  $T_1M$  is compact, it follows that the complement  $W$  of the image of  $\tau$  is a dense open set in  $S^{q-1}$ . Therefore  $W$  meets  $S^q \cap (\mathbb{R}^q - \mathbb{R}^{q-1})$  in a nonempty open set  $W_0$ . As we saw previously  $W_0$  contains a vector  $v$  which is not in the image of  $\sigma$ . This vector  $v$  has the property that  $f_v|_M: M \rightarrow \mathbb{R}^q$  is an injective immersion. Since  $M$  is compact and Hausdorff,  $f_v|_M$  is also an embedding.

QED

There are some remarks to be made concerning the theorem just proved. It is easily converted to an *approximation theorem*: given any  $C^r$  map  $g: M \rightarrow \mathbb{R}^k$ ,  $k \geq 2n + 1$ , and any  $\varepsilon > 0$ , there is a  $C^r$  embedding  $f: M \rightarrow \mathbb{R}^k$  such that  $|f(x) - g(x)| < \varepsilon$  for all  $x \in M$ . To prove this, let  $h: M \rightarrow \mathbb{R}^s$  be a

$C^r$  embedding for some  $s$ . Then the map

$$H = g \times h: M \rightarrow \mathbb{R}^k \times \mathbb{R}^s$$

is a  $C^r$  embedding, and  $g$  is the composition of  $H$  with the projection  $\pi: \mathbb{R}^k \times \mathbb{R}^s \rightarrow \mathbb{R}^k$ . Identifying  $M$  with  $H(M) \subset \mathbb{R}^{k+s}$ , we see that it suffices to approximate  $\pi$  by a  $C^r$  map which restricts to an embedding of  $M$ . Now  $\pi$  is the composition of linear projections

$$\mathbb{R}^k \times \mathbb{R}^s \rightarrow \mathbb{R}^k \times \mathbb{R}^{s-1} \rightarrow \cdots \rightarrow \mathbb{R}^k \times \mathbb{R}^1 \rightarrow \mathbb{R}^k.$$

By induction on  $s$  it suffices to prove that if  $M \subset \mathbb{R}^{k+s}$ , any linear projection into  $\mathbb{R}^{k+s-1}$  can be approximated by a linear projection which embeds  $M$ , provided  $k + s > 2n + 1$ . This is exactly what was proved.

Whitney [4] showed that Theorem 3.5 can be improved: for  $n > 0$ , every paracompact Hausdorff  $n$ -manifold embeds in  $\mathbb{R}^{2n}$ ; moreover it immerses in  $\mathbb{R}^{2n-1}$  if  $n > 1$ . However, the approximation version *cannot* be improved: if  $S^1$  is mapped into  $\mathbb{R}^2$  so that the image curve crosses itself like a figure 8, no sufficiently close approximation can be injective.

The requirement  $r \geq 2$  in Theorem 3.5 can be weakened to  $r \geq 1$ . This follows from the result in the next chapter that every  $C^1$  manifold has a compatible  $C^\omega$  differential structure. In fact Theorem 3.5 is true for  $C^0$  manifolds, and even for compact metric spaces; see for example, the books by Pontryagin [2] or Hurewicz and Wallman [1]. In the other direction, Theorem 3.5 is also true for real analytic manifolds; see Chapters 2 or 4. Our proof shows that if  $M$  has a  $C^\omega$  embedding in some  $\mathbb{R}^q$ , it has one in  $\mathbb{R}^{2n+1}$ .

We conclude this section with the observation that Theorem 3.5 can be improved by one dimension if we want only an immersion. For we may assume  $M \subset \mathbb{R}^{2n+1}$ , and can then find  $v \in S^{2n} - \mathbb{R}^{2n}$  satisfying (2). Thus we see that every compact Hausdorff  $C^r$   $n$ -manifold,  $r \geq 2$ , has a  $C^r$  immersion into  $\mathbb{R}^{2n}$ . In fact every  $C^r$  map  $M \rightarrow \mathbb{R}^{2n}$  can be approximated by immersions.

More refined approximation theorems of this type are given in Theorems 3.2.12 and 3.2.13. More sophisticated proofs are given in Section 2.4 and at the end of Chapter 3.

### Exercises

1. An injective immersion might not be an embedding, since there is an injective immersion of the line in the plane whose image is a figure 8. However, an injective immersion of a compact Hausdorff manifold is an embedding.
- \*2. Let  $M$  be a connected Hausdorff noncompact  $C^r$  manifold,  $r \geq 0$ . Then there is a closed  $C^r$  embedding of the half line  $[0, \infty)$  into  $M$ .
3. (a) There is an immersion of the *punctured torus*  $S^1 \times S^1 - \{\text{point}\}$  in  $\mathbb{R}^2$ . [Hint: spread out the puncture.]  
 \*(b) There is an immersion of the punctured  $n$ -torus,  $(S^1)^n - \{\text{point}\}$ , in  $\mathbb{R}^n$ .
4. Any product of spheres can be embedded in Cartesian space of one dimension higher.
- \*5. There is no immersion of the Möbius band in the plane.



6. The line with two origins (see Exercise 10, Section 1.1) immerses in  $\mathbb{R}$ .
7.  $T_1 S^2$  (the unit tangent bundle of  $S^2$ ) is diffeomorphic to  $P^3$ .
8. Let  $M$  be a compact  $C^1$  manifold. Every  $C^1$  map  $M \rightarrow \mathbb{R}$  has at least two critical points.
9. Let  $f: S^1 \rightarrow \mathbb{R}$  be a  $C^1$  map and  $y \in \mathbb{R}$  a regular value.  
 (a)  $f^{-1}(y)$  has an even number of points  
 (b) If  $f^{-1}(y)$  has  $2k$  points,  $f$  has at least  $2k$  critical points.  
 \*(c) Let  $g: S^2 \rightarrow \mathbb{R}$  be a  $C^1$  map and  $y \in g(S^2)$  a regular value. If  $g^{-1}(y)$  has  $k$  components then  $g$  has at least  $k + 1$  critical points. [Use the Jordan curve theorem.]
- \*10. Every  $C^2$  map  $f: T^2 \rightarrow \mathbb{R}$  has at least 3 critical points. [ $T^2 = S^1 \times S^1$  is the torus. If  $f$  has only a maximum  $p_+$  and a minimum  $p_-$  let  $U$  be a simply connected neighborhood of  $p_-$ . Let  $\varphi_t: T^2 \rightarrow T^2$ ,  $t \in \mathbb{R}$ , be the gradient flow of  $f$ . Then one can show that  $T^2 - p_+ = \bigcup_{t>0} \varphi_t(U)$ . This makes  $T^2 - p_+$  simply connected.]
11. (a) Regarding  $S^1$  as the equator of  $S^2$ , we obtain  $P^1$  as a submanifold of  $P^2$ . Show that  $P^1$  is not a regular level surface of any  $C^1$  map on  $P^2$ . [Hint: no neighborhood of  $P^1$  in  $P^2$  is separated by  $P^1$ .]  
 (b) Generalize (a) to  $P^n \subset P^{n+1}$ .
12. A surface of genus  $p$  is a 2-dimensional manifold homeomorphic to the space obtained by removing the interiors of  $2p$  disjoint 2-disks from  $S^2$  and attaching  $p$  disjoint cylinders to their boundaries (Figure 1-5).
- \*(a) For each nonnegative integer  $p$  there is a polynomial map  $f_p: \mathbb{R}^3 \rightarrow \mathbb{R}$  having 0 as a regular value, such that  $f_p^{-1}(0)$  is a surface of genus  $p$ . For example:

$$f_0(x, y, z) = x^2 + y^2 + z^2 - 1$$

$$f_1(x, y, z) = (x^2 + y^2 - 4)^2 + z^2 - 1$$

$$f_2(x, y, z) = [4x^2(1 - x^2) - y^2]^2 + z^2 - \frac{1}{4}$$

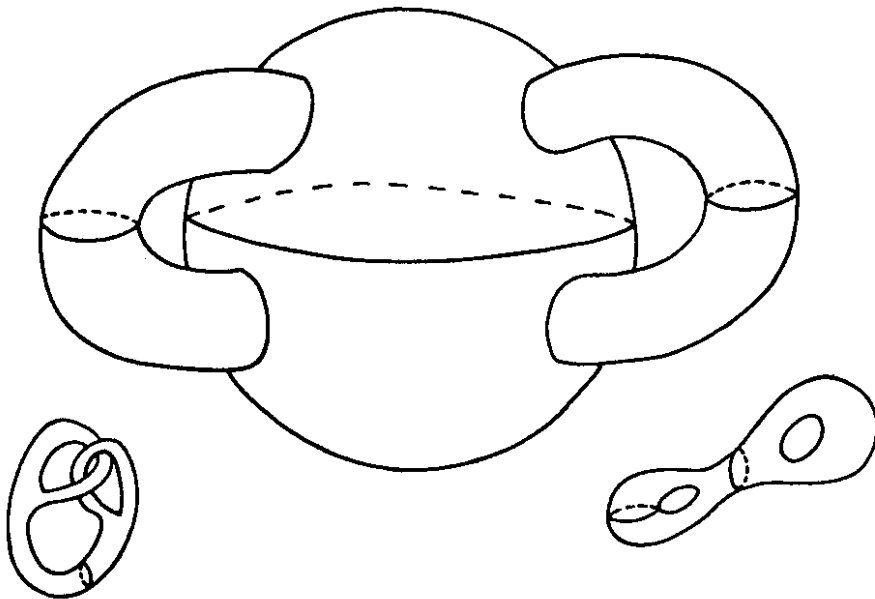

Figure 1-5. Orientable surfaces of genus  $p = 2$ .

[Consider functions of the form  $(F(x, y))^2 + z^2 - \epsilon^2$  where  $F(x, y) = 0$  defines a closed curve in  $\mathbb{R}^2$  with  $p - 1$  crossings,  $p \geq 1$ .]  
 \*\*\*(b) What is the minimal degree of  $f_p$ ?

- \*13. A  $C^1$  surface of genus  $p$  has a  $C^1$  map into  $\mathbb{R}$  which has exactly 3 critical points, for all  $p \geq 0$ .
- \*14. The proof of the compact embedding Theorem 3.4 can be adapted to show that every paracompact Hausdorff manifold is homeomorphic to a closed subset of a Banach space. It follows that such a manifold has a complete metric.
- \*15.  $P^2$  embeds in  $\mathbb{R}^4$ . [Think of  $P^2$  as the union of a Möbius band  $M$  and a disk  $D$ . Embed  $M$  and  $D$  in  $\mathbb{R}^3$  with a common boundary circle  $S^1$ ; then push them out into opposite sides of  $\mathbb{R}^3$  in  $\mathbb{R}^4$  leaving  $S^1$  fixed.]
16. Embeddings of  $P^n$  in  $S^{n+k}$  can be constructed as follows (Hopf [1], James [1]). Let  $h: \mathbb{R}^{n+1} \times \mathbb{R}^{n+1} \rightarrow \mathbb{R}^{n+k+1}$  be a symmetric bilinear map such that  $h(x, y) \neq 0$  if  $x \neq 0$  and  $y \neq 0$ . Define  $g: S^n \rightarrow S^{n+k}$  by  $g(x) = h(x, x)/|h(x, x)|$ .  
 (a)  $g(x) = g(y)$  if and only if  $x = \pm y$ . [Hint: consider  $h(x + \lambda y, x - \lambda y)$  if  $h(x, x) = \lambda^2 h(y, y)$ .]  
 (b)  $g$  induces an analytic embedding  $P^n \rightarrow S^{n+k}$ .  
 (c)  $P^n$  embeds in  $S^{2n}$  for all  $n$ . [Hint: let  $h: \mathbb{R}^{n+1} \times \mathbb{R}^{n+1} \rightarrow \mathbb{R}^{2n+1}$ ,

$$h(x_0, \dots, x_n, y_0, \dots, y_n) = (z_0, \dots, z_{2n})$$

$$\text{where } z_k = \sum_{i+j=k} x_i y_j.]$$

## 4. Manifolds with Boundary

Our definition of manifold excludes many objects on which differentiable maps and tangent vectors are naturally defined; the closed unit ball in  $\mathbb{R}^n$  is an example. Many such objects are "manifolds with boundary," a concept we now explain.

A *halfspace* of  $\mathbb{R}^n$ , or an *n-halfspace*, is a subset of the form

$$H = \{x \in \mathbb{R}^n: \lambda(x) \geq 0\}$$

where  $\lambda: \mathbb{R}^n \rightarrow \mathbb{R}$  is a linear map. If  $\lambda \equiv 0$  then  $H = \mathbb{R}^n$ ; otherwise  $H$  is called a *proper* halfspace. If  $H$  is proper, its *boundary* is the set  $\partial H = \text{kernel } \lambda$ ; this a linear subspace of dimension  $n - 1$ . If  $H = \mathbb{R}^n$  we set  $\partial H = \emptyset$ .

We now extend the definition of chart on a space  $M$  to mean a map  $\varphi: U \rightarrow \mathbb{R}^n$  which maps the open set  $U \subset M$  homeomorphically onto an open subset of a halfspace in  $\mathbb{R}^n$ . This includes all charts as defined earlier, since  $\mathbb{R}^n$  is itself a halfspace; and many new charts as well. Using this definition of chart, we systematically extend the meaning of atlas,  $C^r$  atlas,  $C^r$  differential structure, and finally,  $C^r$  manifold.

Let  $(M, \Phi)$  be a  $C^r$  manifold (in the new sense). Suppose  $(\varphi, U) \in \Phi$  and  $\varphi(U)$  is an open subset of a proper halfspace  $H \subset \mathbb{R}^n$ . If  $x \in \varphi^{-1}(\partial H)$  we say  $x$  is a *boundary point* for the chart  $(\varphi, U)$ . This condition is independent of the chart. This is the same as saying that a coordinate change cannot map an interior point of a halfspace onto a boundary point. If  $r \geq 1$  this follows from the inverse function theorem. If  $r = 0$  it follows from "invariance of

domain". This is the classical and difficult topological theorem which states that a subset of  $\mathbb{R}^n$  is open if it is homeomorphic to an open set; see Hurewicz and Wallman [1] for example.

The *boundary* of the manifold  $(M, \Phi)$  is defined to be the set of points  $x \in M$  which are boundary points for some (hence any) chart; the boundary is denoted by  $\partial M$ .

If  $(M, \Phi)$  is a  $C^r$  manifold, a  $C^r$  atlas for  $\partial M$  is obtained as follows. Let  $(\varphi, U) \in \Phi$  and  $U \cap \partial M \neq \emptyset$ . Let  $H \subset \mathbb{R}^n$  be a halfspace containing  $\varphi(U)$  such that  $U \cap \partial M = \varphi^{-1}(\partial H)$ . Let  $L: \partial H \rightarrow \mathbb{R}^{n-1}$  be any linear isomorphism; then  $(L\varphi, U \cap \partial M)$  is a chart on  $\partial M$ . The set of all such charts is a  $C^r$  atlas on  $\partial M$ . In this way  $\partial M$  is a  $C^r$  manifold of dimension  $n - 1$ .

If  $\partial M \neq \emptyset$  we call  $M$  a  $\partial$ -manifold. If  $\partial M = \emptyset$  we call  $M$  a *manifold without boundary*.

The definition of  $C^r$  map between  $C^r$  manifolds is unchanged, as are the definitions of tangent vectors and the tangent bundle (if  $r \geq 1$ ). The concepts of immersions, submersion, diffeomorphism and embedding go through as before.

Some care is necessary in defining "submanifold." We want, for example, a closed disk to be a submanifold of the plane. But what about a closed disk contained in a halfspace in  $\mathbb{R}^3$ , whose boundary meets the boundary of the halfspace at one point? Or even worse, in a Cantor set? These are images of embeddings, and should be "submanifolds."

We first redefine  $C^r$  submanifold of  $\mathbb{R}^n$  of dimension  $k$ . This is now to mean a subset  $V \subset \mathbb{R}^n$  such that each point of  $V$  belongs to the domain of a chart  $\psi: W \rightarrow \mathbb{R}^n$  of  $\mathbb{R}^n$ , such that

$$V \cap W = \psi^{-1}(H)$$

for some  $k$ -halfspace  $H \subset \mathbb{R}^k \subset \mathbb{R}^n$ .

Now let  $M$  be a  $C^r$  manifold, with or without boundary. A subset  $A \subset M$  is a  $C^r$  submanifold if each point of  $A$  belongs to the domain of a chart  $\varphi: U \rightarrow \mathbb{R}^n$  of  $M$  such that  $\varphi(U \cap A)$  is a  $C^r$  submanifold (in the sense just defined) of  $\mathbb{R}^n$ .

It is useful to have a term for a submanifold  $A \subset M$  whose boundary is nicely placed in  $\partial M$ . We call  $A$  a *neat* submanifold if  $\partial A = A \cap \partial M$  and  $A$  is covered by charts  $(\varphi, U)$  of  $M$  such that

$$A \cap U = \varphi^{-1}(\mathbb{R}^m)$$

where  $m = \dim A$ . (See Figure 1-6.) A *neat embedding* is one whose image is a neat submanifold.

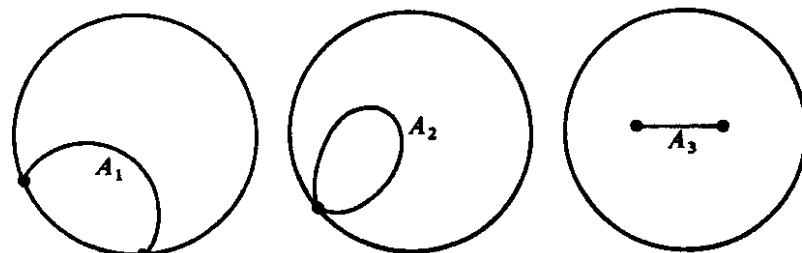

Figure 1-6.  $A_1$  is neat;  $A_2$  and  $A_3$  are not.

If  $A$  is a submanifold of  $M$  and  $\partial A = \emptyset$  then  $A$  is neat if and only if  $A \cap \partial M = \emptyset$ . In general,  $A$  is neat if and only if  $\partial A = A \cap \partial M$  and (for  $r \geq 1$ )  $A$  is not tangent to  $\partial M$  at any point  $x \in \partial A$ ; that is,  $A_x \not\subset (\partial M)_x$ .

The regular value theorem for  $\partial$ -manifolds takes the following form:

**4.1. Theorem.** Let  $M$  be a  $C^r$   $\partial$ -manifold and  $N$  a  $C^r$  manifold,  $r \geq 1$ . Let  $f: M \rightarrow N$  be a  $C^r$  map. If  $y \in N - \partial N$  a regular value for both  $f$  and  $f|_{\partial M}$ , then  $f^{-1}(y)$  is a neat  $C^r$  submanifold of  $M$ .

A generalization of Theorem 3.3 to  $\partial$ -manifolds is:

**4.2. Theorem.** Let  $A \subset N$  be a  $C^r$  submanifold and  $f: M \rightarrow N$  a  $C^r$  map. Suppose  $\partial A = \emptyset$  and  $f, f|_{\partial M}$  are both transverse to  $A$ . Then  $f^{-1}A$  is a  $C^r$  submanifold with boundary  $(f^{-1}A) \cap \partial M$ .

The proofs of Theorems 4.1 and 4.2 are left to the reader.

The embedding Theorems 3.4 and 3.5 go through with only minor changes. With some care one can prove:

**4.3. Theorem.** Let  $M$  be a  $C^r$   $n$ -dimensional manifold,  $r \geq 1$ , which is compact Hausdorff. Then there is a neat  $C^r$  embedding of  $M$  into a halfspace of  $\mathbb{R}^{2n+1}$ .

The remarks following Theorem 3.5 are applicable here as well.

### Exercises

1. The cartesian product of two  $C^0$   $\partial$ -manifolds is a  $\partial$ -manifold.
2. A  $C^1$  map  $M \rightarrow N$  takes regular points in  $M - \partial M$  into  $N - \partial N$ .
3. Let  $M$  be the closed upper halfplane. For any  $C^1$  map  $g: \mathbb{R} \rightarrow \mathbb{R}$ , the map  $f(x, y) = y + g(x)$ , from  $M$  to  $\mathbb{R}$ , has every point of  $M$  for a regular point. Set

$$g(x) = \begin{cases} e^{-(1/x^2)} \sin(1/x) & \text{if } x \neq 0 \\ 0 & \text{if } x = 0. \end{cases}$$

Then  $f: M \rightarrow \mathbb{R}$  is  $C^\infty$ , 0 is a regular value, but  $f^{-1}(0)$  is not a manifold.

4. Let  $A \subset N$  be a neat  $C^r$  submanifold,  $r > 0$ . Let  $f: (M, \partial M) \rightarrow (N, \partial N)$  be a  $C^r$  map. Suppose every point of  $A$  [respectively  $\partial A$ ] is a regular value of  $f$  [resp.  $f: \partial M \rightarrow \partial N$ ]. Then  $f^{-1}(A)$  is a neat  $C^r$  submanifold of  $M$ .

5. Let  $f: M \rightarrow \mathbb{R}$  be  $C^r$ ,  $r > 0$ . Suppose  $f$  is constant on each component of  $\partial M$ . Let  $a$  and  $b$  be regular values. Then the sets  $f^{-1}(a)$ ,  $f^{-1}[a, b]$ ,  $f^{-1}(a, b)$ , and  $f^{-1}[a, \infty)$  are  $C^r$  submanifolds of  $M$ .

\*6. There is a  $C^\infty$  map  $f: D^3 \rightarrow D^2$  with  $0 \in D^2$  as a regular value, such that  $f^{-1}(0)$  is a knotted curve (Figure 1-7).

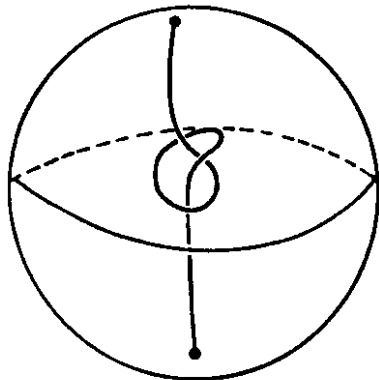

Figure 1-7.

7. (a) The *double* of a  $\partial$ -manifold  $M$  is the identification space obtained from  $(M \times 0) \cup (M \times 1)$  by identifying  $(x, 0)$  and  $(x, 1)$  if  $x \in \partial M$ . The double is a  $C^0$  manifold without boundary, of the same dimension, in which  $M$  is embedded.

8. If  $\partial M = \emptyset$  then  $M$  is a boundary, i.e.,  $M = \partial N$  for some  $\partial$ -manifold  $N$ . However, if  $M$  is compact, it may be impossible to choose  $N$  compact. [Suppose  $M$  has dimension 0.]

9. A 1-dimensional connected paracompact Hausdorff  $\partial$ -manifold of class  $C^r$ ,  $0 \leq r \leq \infty$ , is  $C^r$  diffeomorphic to either a closed, or a half open, finite interval. (This is also true, but hard, for  $r = \omega$ .)

10. Diffeomorphic manifolds have diffeomorphic boundaries.

11. A  $C^1$  manifold is *orientable* if it has an atlas such that all coordinate changes have positive Jacobian determinants at every point. If  $M$  is orientable so is  $\partial M$ ; but the converse can be false.

12. A subset  $Q$  of a Cartesian space  $\mathbb{R}^n$  is an *orthant* if there is a linear isomorphism  $L: \mathbb{R}^n \approx \mathbb{R}^{n_1} \times \cdots \times \mathbb{R}^{n_k}$  and halfspaces  $H_i \subset \mathbb{R}^{n_i}$  such that  $L(Q) = H_1 \times \cdots \times H_k$ . There is a category of " $C^r$  manifolds with convex corners" whose charts are homeomorphisms onto open subsets of orthants. This category contains all  $C^r$  manifolds, with and without boundaries, and is *closed under Cartesian product*.

## 5. A Convention

Manifolds that are not paracompact are amusing, but they never occur naturally. What is perhaps worse, it is difficult to prove anything about them. Non-Hausdorff manifolds occasionally turn up (see Exercise 11,

Section 1.1) but again it is hard to prove anything interesting. It is convenient to deal only with manifolds having a countable number of components. We therefore adopt the following convention:

*All manifolds appearing henceforth are assumed to be paracompact, with a countable base, and all spaces Hausdorff, unless there is an explicit statement to the contrary.*

Of course any space or manifold we construct must be shown to have these properties; the proof is usually trivial.

## Chapter 2

### Function Spaces

The statement sometimes made, that there exist only analytic functions in nature, is in my opinion absurd.

—F. Klein, *Lectures on Mathematics*,  
1893

Many problems in differential topology can be rephrased as questions about function spaces; this often leads to new insights and greater unity. For example, in Chapter 1 we constructed “by hand” an embedding of any compact manifold  $M$  in some  $\mathbb{R}^q$ ; in this chapter we shall exploit the topology of a space of maps of  $M$  to  $N$  to prove that any map  $M \rightarrow N$  can be approximated by embeddings if  $\dim N > 2 \dim M$ .

The most useful topology on the set  $C^r(M, N)$  of  $C^r$  maps from  $M$  to  $N$  is the strong topology. Roughly speaking, a neighborhood of  $f$  in the strong topology consists of all maps  $g$  which are close to  $f$  together with their derivatives of order  $r$ . The degree of closeness is specified by arbitrary positive numbers controlling the closeness of derivatives of local representations of  $f$  and  $g$ .

The weak (or “ $C^r$  compact-open”) topology on  $C^r(M, N)$  controls the closeness of maps only over compact sets. When  $M$  is compact it is the same as the strong topology.

Section 2.3 briefly indicates the changes needed to extend the approximation theorems to  $\partial$ -manifolds and manifold pairs.

In Section 2.4 jets are defined and used to give an indirect definition of the weak and strong topologies. The density of embeddings is proved again by exploiting the Baire property. The last section discusses, without proofs, various results on analytic approximations.

As deeper approximation and globalization techniques are developed they are used to improve the Whitney embedding and immersion theorems of the preceding chapter. Thus the density of immersions and embeddings is re-examined in Sections 2.1 and 2.2 and again in Section 2.4. The final form of the density of embeddings is Theorem 2.13.

#### 1. The Weak and Strong Topologies on $C^r(M, N)$

If  $M$  and  $N$  are  $C^r$  manifolds,  $C^r(M, N)$  denotes the set of  $C^r$  maps from  $M$  to  $N$ . At first we assume  $r$  is finite.

The weak or “compact-open  $C^r$ ” topology on  $C^r(M, N)$  is generated by the sets defined as follows. Let  $f \in C^r(M, N)$ . Let  $(\varphi, U)$ ,  $(\psi, V)$  be charts

on  $M, N$ ; let  $K \subset U$  be a compact set such that  $f(K) \subset V$ ; let  $0 < \varepsilon \leq \infty$ . Define a weak subbasic neighborhood

$$(1) \quad \mathcal{N}^r(f; (\varphi, U), (\psi, V), K, \varepsilon)$$

to be the set of  $C^r$  maps  $g: M \rightarrow N$  such that  $g(K) \subset V$  and

$$\|D^k(\psi f \varphi^{-1})(x) - D^k(\psi g \varphi^{-1})(x)\| < \varepsilon$$

for all  $x \in \varphi(K)$ ,  $k = 0, \dots, r$ . This means that the local representations of  $f$  and  $g$ , together with their first  $k$  derivatives, are within  $\varepsilon$  at each point of  $K$ .

The weak topology on  $C^r(M, N)$  is generated by these sets (1); it defines the topological space  $C_w^r(M, N)$ . A neighborhood of  $f$  is thus any set containing the intersection of a finite number of sets of type (1).

If the proof of the easy Whitney embedding theorem (Theorem 1.3.5) is reexamined one sees that it proves the following approximation result:

**1.0. Proposition.** *Let  $M$  be a compact  $C^r$  manifold,  $2 \leq r < \infty$ . Then embeddings are dense in  $C_w^r(M, \mathbb{R}^q)$  if  $q > 2 \dim M$ , while immersions are dense if  $q \geq 2 \dim M$ .*

It can be shown that  $C_w^r$  has very nice features: for example it has a complete metric and a countable base; if  $M$  is compact it is locally contractible, and  $C_w^r(M, \mathbb{R}^m)$  is a Banach space.

If  $M$  is not compact the weak topology does not control the behavior of a map “at infinity” very well. For this purpose the strong topology is useful. (This topology is also called the fine or Whitney topology) A base consists of sets of the following type. Let  $\Phi = \{\varphi_i, U_i\}_{i \in \Lambda}$  be a locally finite set of charts on  $M$ ; this means that every point of  $M$  has a neighborhood which meets  $U_i$  for only a finite number of  $i$ . Let  $K = \{K_i\}_{i \in \Lambda}$  be a family of compact subsets of  $M$ ,  $K_i \subset U_i$ . Let  $\Psi = \{\psi_i, V_i\}_{i \in \Lambda}$  be a family of charts on  $N$ , and  $\varepsilon = \{\varepsilon_i\}_{i \in \Lambda}$  a family of positive numbers. If  $f \in C^r(M, N)$  takes each  $K_i$  into  $V_i$ , define a strong basic neighborhood

$$(2) \quad \mathcal{N}^r(f; \Phi, \Psi, K, \varepsilon)$$

to be the set of  $C^r$  maps  $g: M \rightarrow N$  such that for all  $i \in \Lambda$ ,  $g(K_i) \subset V_i$  and

$$\|D^k(\psi_i f \varphi_i^{-1})(x) - D^k(\psi_i g \varphi_i^{-1})(x)\| < \varepsilon_i$$

for all  $x \in \varphi_i(K_i)$ ,  $k = 0, \dots, r$ . The strong topology has all possible sets of this form for a base.

It must of course be verified these sets (2), as  $f, \Phi, \Psi, K, \varepsilon$  vary, actually form a base for a topology. We leave this to the reader as an exercise; it also follows from alternative description of the topology given in Section 4.

The topological space  $C_s^r(M, N)$  resulting from the strong topology is the same as  $C_w^r(M, N)$  if  $M$  is compact. If  $M$  is not compact, however, and  $N$  has positive dimension, it is an extremely large topology: it is not metrizable and in fact does not have a countable base at any point; and it

has uncountably many components. It does have one saving grace, however: the category theorem of Baire is valid in  $C_S^r(M, N)$ , as will be proved in Section 2.4.

We now define the spaces  $C_W^r(M, N)$  and  $C_S^r(M, N)$ . The weak topology on  $C^r(M, N)$  is simply the union of the topologies induced by the inclusion maps  $C^r(M, N) \rightarrow C_W^r(M, N)$  for  $r$  finite, while the strong topology on  $C^r(M, N)$  is the union of the topologies induced by  $C^r(M, N) \rightarrow C_S^r(M, N)$ .

We give  $C^r(M, N)$  the weak and strong topologies induced from  $C^r(M, N)$ .

The strong topology is very convenient for differential topology in that many important subsets are open. For example:

**1.1. Theorem.** *The set  $\text{Imm}^r(M, N)$  of  $C^r$  immersions is open in  $C_S^r(M, N)$ ,  $r \geq 1$ .*

*Proof.* Since

$$\text{Imm}^r(M, N) = \text{Imm}^1(M, N) \cap C^r(M, N)$$

it suffices to prove this for  $r = 1$ . If  $f: M \rightarrow N$  is a  $C^1$  immersion one can choose a neighborhood  $\mathcal{N}^1(f; \Phi, \Psi, K, \varepsilon)$  as follows. Let  $\Psi^0 = \{\psi_\beta, V_\beta\}_{\beta \in B}$  be any atlas for  $N$ . Pick an atlas  $\Phi = \{\varphi_i, U_i\}_{i \in A}$  for  $M$  so that each  $U_i$  has compact closure, and for each  $i \in A$  there exists  $\beta(i) \in B$  such that  $f(U_i) \subset V_{\beta(i)}$ . Put  $V_{\beta(i)} = V_i$ ,  $\psi_{\beta(i)} = \psi_i$ , and  $\Psi = \{\psi_i, V_i\}_{i \in A}$ . Let  $K = \{K_i\}_{i \in A}$  be a compact cover of  $M$  with  $K_i \subset U_i$ .

The set

$$A_i = \{D(\psi_i f \varphi_i^{-1})(x) \mid x \in \varphi_i(K_i)\}$$

is a compact set of injective linear maps from  $\mathbb{R}^m$  to  $\mathbb{R}^n$ . Since the set of all injective linear maps is open in the vector space  $L(\mathbb{R}^m, \mathbb{R}^n)$  of all linear maps  $\mathbb{R}^m \rightarrow \mathbb{R}^n$ , there exists  $\varepsilon_i > 0$  such that  $T \in L(\mathbb{R}^m, \mathbb{R}^n)$  is injective if  $\|T - S\| < \varepsilon_i$  and  $S \in A_i$ . Set  $\varepsilon = \{\varepsilon_i\}$ . It follows that every element of  $\mathcal{N}^1(f; \Phi, \Psi, K, \varepsilon)$  is an immersion.

QED

A similar argument, which we leave to the reader, proves:

**1.2. Theorem.** *The set of submersions is open in  $C_S^r(M, N)$ ,  $1 \leq r \leq \infty$ .*

Our next goal is the openness of the set of embeddings. We shall need the following fact:

**1.3. Lemma.** *Let  $U \subset \mathbb{R}^m$  be an open set and  $W \subset U$  an open set with compact closure  $\bar{W} \subset U$ . Let  $f: U \rightarrow \mathbb{R}^n$  be a  $C^1$  embedding. There exists  $\varepsilon > 0$  such that if  $g: U \rightarrow \mathbb{R}^n$  is  $C^1$  and*

$$\|Dg(x) - Df(x)\| < \varepsilon \text{ and } |g(x) - f(x)| < \varepsilon$$

*for all  $x \in W$  then  $g|_W$  is an embedding.*

*Proof.* By Theorem 1.1 (or rather, its proof) and compactness of  $\bar{W}$ , there exists  $\varepsilon_0 > 0$  so small that if  $g \in C^1(U, \mathbb{R}^n)$  and  $\|Dg(x) - Df(x)\| < \varepsilon_0$

for all  $x \in W$  then  $g|_W$  is an immersion. Therefore if the lemma is false there is a sequence  $g_n \in C^1(U, \mathbb{R}^n)$  such that

$$\|Dg_n(x) - Df(x)\| \rightarrow 0$$

and

$$(3) \quad |g_n(x) - f(x)| \rightarrow 0$$

uniformly on  $W$ , while for each  $n$  there exist distinct points  $a_n, b_n$  in  $W$  with  $g_n(a_n) = g_n(b_n)$ . By compactness of  $\bar{W}$  we may assume  $a_n \rightarrow a \in U$ ,  $b_n \rightarrow b \in U$  as  $n \rightarrow \infty$ . Then  $f(a) = f(b)$  by (3), so  $a = b$ . Choosing subsequences if necessary we may assume that the sequence of unit vectors

$$v_n = \frac{a_n - b_n}{|a_n - b_n|}$$

converges to a unit vector  $v \in S^{m-1}$ . By uniformity of Taylor expansion (with remainder in integral form) we have

$$|g_n(a_n) - g_n(b_n) - Dg(b_n)(a_n - b_n)|/|a_n - b_n| \rightarrow 0.$$

Hence  $Df(b_n)v_n \rightarrow 0$ . But this sequence also goes to  $Df(b)v$ , which therefore is 0. This contradicts the assumption that  $f$  is an immersion.

QED

We can now prove:

**1.4. Theorem.** *The set  $\text{Emb}^r(M, N)$  of  $C^r$  embeddings of  $M$  in  $N$  is open in  $C_S^r(M, N)$ ,  $r \geq 1$ .*

*Proof.* It suffices to take  $r = 1$ . Let  $f \in \text{Emb}^1(M, N)$ . By using the preceding lemma we can find the following objects:

- a locally finite atlas  $\Phi = \{\varphi_i, U_i\}_{i \in A}$  of  $M$ ;
- a set  $\Psi = \{\psi_i, V_i\}_{i \in A}$  of charts for  $N$  with  $f(U_i) \subset V_i$ ;
- a family of compact sets  $K_i \subset U_i$  whose interiors  $W_i$  cover  $M$ ;
- numbers  $\varepsilon_i > 0$  such that if

$$g \in \mathcal{N}_0 = \mathcal{N}^1(f; \Phi, \Psi, K, \varepsilon)$$

then  $g(W_i) \subset V_i$  and  $g|_{W_i}$  is a  $C^r$  embedding.

Since  $f$  is an embedding for each  $i \in A$  there exist disjoint open sets  $A_i, B_i$  in  $N$  such that  $f(K_i) \subset A_i$  and  $f(M - U_i) \subset B_i$ . One can find a neighborhood  $\mathcal{N}_1$  of  $f$  in  $C_S^1(M, N)$  (in fact, in  $C_S^0(M, N)$ ) such that if  $g \in \mathcal{N}_1$ , then

$$\begin{aligned} g(K_i) &\subset A_i, \\ g(M - W_i) &\subset B_i. \end{aligned}$$

We show that every  $g \in \mathcal{N}_0 \cap \mathcal{N}_1$  is an embedding. By the choice of  $\mathcal{N}_0$ ,  $g$  is an immersion. To see that  $g$  is injective suppose  $x, y$  are distinct points of  $M$  with  $x \in K_i$ . If  $y \in U_i$  then  $g(x) \neq g(y)$  since  $g|_{U_i}$  is injective;

while if  $y \in M - W_i$  then  $g(x) \in A_i$  and  $g(y) \in B_i$ , so again  $g(x) \neq g(y)$ . To see that  $g: M \rightarrow g(M)$  is a homeomorphism, it suffices to show that if  $y_n$  is a sequence in  $M$  such that  $g(y_n) \rightarrow g(x)$  then  $y_n \rightarrow x$ . If  $x \in K_i$  then  $g(x) \in A_i$ ; hence only a finite number of the  $g(y_n)$  can be in  $B_i$ , so all but a finite number of  $y_n$  are in  $W_i$ . Since  $g|W: W \rightarrow g(W)$  is a homeomorphism it follows that  $y_n \rightarrow x$ .

QED

A map  $f$  is proper if  $f^{-1}$  takes compact sets to compact sets.

**1.5. Theorem.** The set  $\text{Prop}^r(M, N)$  of proper  $C^r$  maps  $M \rightarrow N$  is open in  $C_S^r(M, N)$ ,  $r \geq 0$ .

*Proof.* For any map  $f: M \rightarrow N$  there is a compact cover  $\{K_i\}_{i \in A}$  of  $M$  and an open cover  $\mathcal{V} = \{V_i\}_{i \in A}$  of  $f(N)$  with  $f(K_i) \subset V_i$ . If  $f$  is proper  $\mathcal{V}$  can be chosen locally finite. There is a neighborhood  $\mathcal{N}$  of  $f$  such that if  $g \in \mathcal{N}$  then  $g(K_i) \subset V_i$  for all  $i$ . To see that such a  $g$  is proper, let  $L \subset N$  be compact. Then  $L$  meets only a finite number of  $V_i$ . Hence  $g^{-1}(L)$  is a closed subset of  $M$  which is covered by finitely many of the compact sets  $K_i$ ; therefore  $g^{-1}(L)$  is compact.

QED

Since an embedding  $f: M \rightarrow N$  is proper if and only if  $f(M)$  is closed in  $N$ , we obtain:

**1.6. Corollary.** The set of closed embeddings is open in  $C_S^r(M, N)$ ,  $r \geq 1$ .

Let  $\text{Diff}^r(M, N)$  denote the set of  $C^r$  diffeomorphisms from  $M$  onto  $N$ .

**1.7. Theorem.** If  $M$  and  $N$  are  $C^r$  manifolds without boundary then  $\text{Diff}^r(M, N)$  is open in  $C_S^r(M, N)$ ,  $r \geq 1$ .

*Proof.* A diffeomorphism induces a bijective correspondence from components of  $M$  to components of  $N$ . Such a map has a neighborhood of maps inducing the same correspondence. Therefore we may assume  $M$  and  $N$  connected.

A diffeomorphism is simultaneously an embedding, a submersion and a proper map. Conversely any map  $g$  between connected manifolds with these three properties is a diffeomorphism. For the image of a submersion is open (by the inverse function theorem) and the image of a proper map is closed; so  $g$  is a surjective embedding, which is a diffeomorphism. Thus  $\text{Diff}^r(M, N)$  is the intersection of three open subsets of  $C_S^r(M, N)$ .

QED

For  $\partial$ -manifolds Theorem 1.6 is false. But one can show that  $\text{Diff}^r(M, N)$  is open in the subspace

$$C_S^r(M, \partial M; N, \partial N) = \{f \in C_S^r(M, N) : f(\partial M) \subset \partial N\}.$$

Theorem 1.6 is false for  $r = 0$ : the set of homeomorphisms is not open in  $C_S^0(M, N)$  (unless it is empty or  $\dim M = 0$ ). There is, however, the following result:

**1.8. Theorem.** Let  $M$  and  $N$  be manifolds without boundary and  $f: M \rightarrow N$  a homeomorphism. Then  $f$  has a neighborhood of surjective maps in  $C_S^0(M, N)$ .

*Proof.* Let  $g$  be near  $f$ ; then  $f^{-1}g$  is near the identity map of  $M$ . Hence it suffices to take  $M = N$  and  $f = 1_M$ .

Let  $\{\varphi_i, U_i\}$  be a locally finite cover of  $M$  by charts such that  $\varphi_i(U_i) \supset D^n$ , the closed unit ball in  $\mathbb{R}^n$ , and  $M = \cup \varphi_i^{-1}(D^n)$ . For each  $i$  let  $B_i \subset \varphi_i(U_i)$  be a slightly larger closed ball,  $0 \in D^n \subset \text{Int } B_i$ . It suffices to find  $\varepsilon_i > 0$  such that if  $h_i: B_i \rightarrow \mathbb{R}^n$  is a continuous map with  $|h_i(x) - x| < \varepsilon_i$  for all  $i$  then  $h(B_i) \supset D^n$ . For if this is true then the set of  $g: M \rightarrow M$  satisfying, for all  $i$ ,

$$g\varphi_i^{-1}(B_i) \subset U_i,$$

and

$$|\varphi_i g \varphi_i^{-1}(x) - x| < \varepsilon_i, \quad \text{all } x \in B_i,$$

will consist of surjective maps (put  $\varphi_i g \varphi_i^{-1} = h_i$ ).

Let  $\varepsilon_i > 0$  be so small that for any  $z \in D^n$ ,  $x \in \partial B_i$  and  $y \in \mathbb{R}^n$  with  $|x - y| < \varepsilon_i$ , it is true that the ray issuing from  $z$  through  $y$  intersects  $\partial B_i$  at a point  $u$  such that  $|u - x| < \text{diam } B_i$  (Figure 2-1).

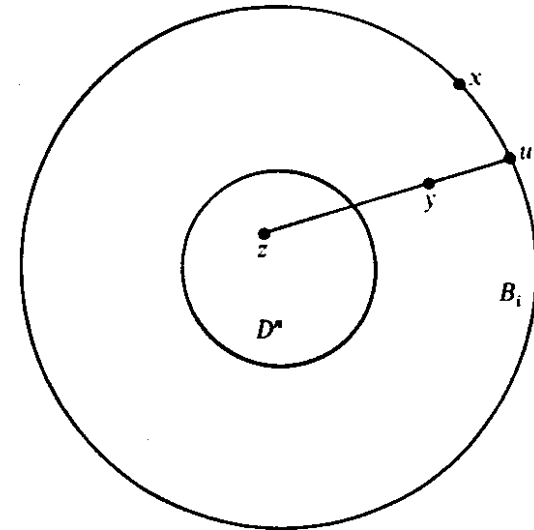

Figure 2-1.

Now suppose  $h: B_i \rightarrow \mathbb{R}^n$  and  $|h(x) - x| < \varepsilon_i$ . Suppose  $z \in D^n - h(B_i)$ . Define a map  $H: B_i \rightarrow \partial B_i$  by sending  $x \in B_i$  to the intersection of  $\partial B_i$  with the ray from  $z$  through  $h(x)$ . The choice of  $\varepsilon_i$  ensures that for  $x \in \partial B_i$ ,  $H(x) \neq -x$ . Then  $H|_{\partial B_i}: \partial B_i \rightarrow \partial B_i$  is homotopic to the identity; the

homotopy moves  $H(x)$  along the shorter great circle path from  $H(x)$  to  $x$  (Figure 2-2). A classical theorem of topology, however, says that no map of an  $n - 1$  sphere to itself which extends to a map of the  $n - 1$  ball to the sphere can be homotopic to the identity. (This will be proved by Theorem 3.1.4). This contradiction shows that  $D^n \subset h(B_i)$ , proving Theorem 1.7.

QED

For  $\partial$ -manifolds one can show that any homeomorphism  $h: M \rightarrow N$  has a neighborhood of surjections in  $C_S^0(M, \partial M; N, \partial N)$ . In fact this follows from Theorem 1.7 by extending  $h$  to a homeomorphism between the doubles of  $M$  and  $N$ .

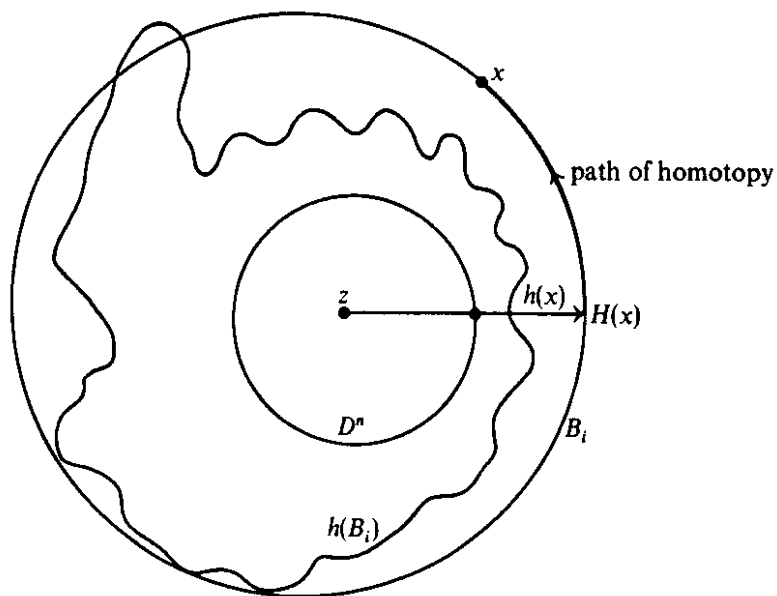

Figure 2-2.

## Exercises

1. The space  $C_S^r(\mathbb{R}, \mathbb{R})$ ,  $r \geq 0$ , does not have a countable base at any point and so is not metrizable. Under the usual operations it is a topological group but not a topological vector space.
2. Let a sequence  $\{f_n\}$  converge to  $g$  in  $C_S^r(M, N)$ ,  $r \geq 0$ . Then there exists a compact set  $K \subset M$  and  $m$  such that  $f_n(x) = g(x)$  for all  $n > m$  and all  $x \in M - K$ .
3. Are  $C_S^{n+1}(\mathbb{R}, \mathbb{R})$  and  $C_W^{n+1}(\mathbb{R}, \mathbb{R})$  homeomorphic to  $C_S^0(\mathbb{R}, \mathbb{R}) \times \mathbb{R}$  and  $C_W^0(\mathbb{R}, \mathbb{R}) \times \mathbb{R}$  respectively,  $n \geq 0$ ?
- \*4. Polynomials are dense in  $C_W^\infty(\mathbb{R}, \mathbb{R})$  but not in  $C_S^0(\mathbb{R}, \mathbb{R})$ .
5. The set of closed maps is closed, but not open, in  $C_S^0(\mathbb{R}, \mathbb{R})$ . (A map  $f$  is closed if it takes closed sets onto closed sets.)

6. The set of closed immersions is open in  $C_S^r(M, N)$ ,  $r \geq 1$ . The set of injective immersions is not open in  $C_S^1(\mathbb{R}^1, \mathbb{R}^2)$ .
7. A proper  $C^1$  immersion  $f: M \rightarrow N$  which is injective on a closed subset  $K \subset M$  is injective on a neighborhood of  $K$ . In fact  $f$  has a neighborhood  $\mathcal{V} \subset C_S^1(M, N)$  and  $K$  has a neighborhood  $U \subset M$  such that every  $g \in \mathcal{V}$  is injective on  $U$ . If  $K$  is compact  $\mathcal{V}$  can be taken in  $C_W^1(M, N)$ .
8. The set of proper maps is open and closed in  $C_S^0(M, N)$ .
9. The set of maps  $f \in C_S^1(M, N)$  such that  $f: M \rightarrow N$  is a covering space, is open. If  $M$  and  $N$  are compact manifolds of the same dimension, without boundaries, then every submersion  $M \rightarrow N$  is a covering space.
10. If  $g: \mathbb{R}^n \rightarrow \mathbb{R}^n$  is a continuous map such that

$$\liminf_{r \rightarrow \infty} \max_{|x|=r} |x - g(x)|/|x| < 1$$

then  $g$  is surjective.

11. The set of neat embeddings of  $M$  in  $N$  is open in  $C_S^r(M, \partial M; N, \partial N)$ ,  $r \geq 1$ . But neat embeddings are not closed in  $C_S^1(D^1, D^2)$ .
12. A base for the strong topology on  $C^r(M, N)$ ,  $0 \leq r < \infty$ , is obtained by taking only those sets  $\mathcal{N}^r(f; \Phi, \Psi, K, \epsilon)$  where it is further required that  $K = \{K_i\}_{i \in I}$  be a covering of  $M$  by compact sets.
13. Let  $\text{Imm}_K^r(M, N)$  be the set of  $C^r$  maps  $M \rightarrow N$  which are immersive at each point of  $K \subset M$ ,  $r \geq 1$ . If  $K$  is compact then this set is open in  $C_W^r(M, N)$ .
14. Let  $\text{Emb}_K^r(M, N)$  be the set of  $C^r$  maps  $f: M \rightarrow N$ ,  $r \geq 1$ , such that  $f|U$  is an embedding for some open set  $U$  (depending on  $f$ ),  $K \subset U \subset M$ . If  $K$  is compact then  $\text{Emb}_K^r(M, N)$  is open in  $C_W^r(M, N)$ .
15. Let  $M, N$  be  $C^r$  manifolds,  $0 \leq r \leq \infty$ . Let  $\{U_i\}_{i \in I}$  be a locally finite family of open subsets of  $M$ . For each  $i \in I$  let  $\mathcal{A}_i \subset C_W^r(U_i, N)$  be an open set. Then the set of  $C^r$  maps  $f: M \rightarrow N$  such that  $f|U_i \in \mathcal{A}_i$  for all  $i$  is open in  $C_S^r(M, N)$ .
16. Let  $M, N$  be  $C^r$  manifolds  $0 \leq r \leq \infty$ . Let  $V \subset M$  be an open set.
  - (a) The restriction map

$$\delta: C^r(M, N) \rightarrow C^r(V, N),$$

$$\delta(f) = f|V$$

is continuous for the weak topologies but not always for the strong. On the other hand:  
 \*(b)  $\delta$  is open for the strong topologies, but not always for the weak.

## 2. Approximations

In this section all manifolds are without boundary.

Our first job is to find a  $C^\infty$  map  $\lambda: \mathbb{R}^n \rightarrow [0, 1]$  with the following properties, for any given  $b > a > 0$ :

- (i)  $\lambda(x) = 1$  if  $|x| \leq a$ ,
- (ii)  $1 > \lambda(x) > 0$  if  $a < |x| < b$ ,
- (iii)  $\lambda(x) = 0$  if  $|x| \geq b$ .

Such a map is sometimes called a *bump function*.

We start with the  $C^\infty$  map  $\alpha: \mathbb{R} \rightarrow \mathbb{R}$ , showing its graph below:

$$\alpha(x) = \begin{cases} 0 & \text{if } x \leq 0 \\ e^{-1/x} & \text{if } x > 0 \end{cases}$$

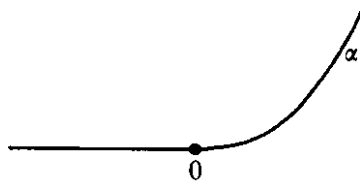

Next define  $\beta: \mathbb{R} \rightarrow \mathbb{R}$ :

$$\beta(x) = \alpha(x - a)\alpha(b - x)$$

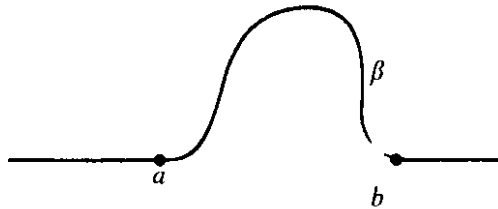

Then define  $\gamma: \mathbb{R} \rightarrow [0,1]$ ,

$$\gamma(x) = \int_x^b \beta / \int_a^b \beta$$

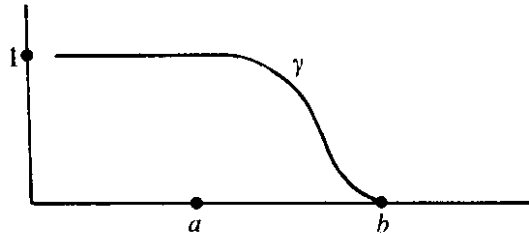

Finally define  $\lambda: \mathbb{R}^n \rightarrow [0,1]$  by

$$\lambda(x) = \gamma(|x|).$$

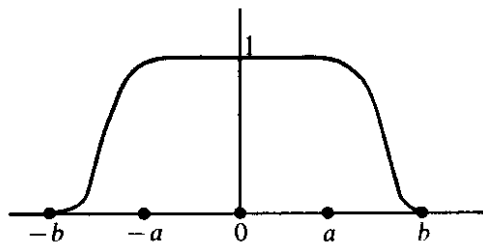

Next we define the *support*  $\text{Supp } f$  of a continuous real valued function  $f$  to be the closure of  $f^{-1}(\mathbb{R} - 0)$ . The complement of  $\text{Supp } f$  is the largest open set on which  $f$  vanishes.

Let  $M$  be a  $C^r$  manifold,  $0 \leq r \leq \infty$ , and  $\mathcal{U} = \{U_i\}_{i \in I}$  an open cover. A  $C^r$  partition of unity subordinate to  $\mathcal{U}$  is a family of  $C^r$  maps  $\lambda_i: M \rightarrow [0,1]$ ,  $i \in I$  such that the following conditions hold:

$$\begin{aligned} \text{Supp } \lambda_i &\subset U_i \quad (i \in I), \\ \{\text{Supp } \lambda_i\}_{i \in I} &\text{ is locally finite,} \end{aligned}$$

and

$$\sum_{i \in I} \lambda_i(x) = 1 \quad (x \in M).$$

Local finiteness ensures that each point has a neighborhood on which all but finitely many  $\lambda_i$  are 0; therefore the sum is locally a finite sum. The third condition ensures that

$$M = \bigcup_i \text{Int Supp } \lambda_i.$$

(The interior of any set  $S$  is denoted by  $\text{Int } S$ .) Therefore  $\{\text{Int Supp } \lambda_i\}_{i \in I}$  is a locally finite open cover of  $M$  which is a shrinking of  $\mathcal{U}$ . (A cover  $\mathcal{V} = \{V_i\}_{i \in A}$  is a *shrinking* of  $\mathcal{U}$  if each  $\bar{V}_i \subset U_i$ .)

The following remark is often useful. If  $\mathcal{V} = \{V_\alpha\}_{\alpha \in A}$  is an open cover of  $M$  which refines  $\mathcal{U} = \{U_i\}_{i \in I}$ , and if  $\mathcal{V}$  has a subordinate  $C^r$  partition of unity, then so has  $\mathcal{U}$ . For let  $\{\lambda_\alpha\}_{\alpha \in A}$  be subordinate to  $\mathcal{V}$ . Let  $f: A \rightarrow I$  be such that  $V_\alpha \subset U_{f(\alpha)}$  and define

$$\mu_i: M \rightarrow [0,1],$$

$$\mu_i(x) = \sum \{\lambda_\alpha(x); \alpha \in f^{-1}(i)\}.$$

Then  $\{\text{Supp } \mu_i\}_{i \in I}$  is locally finite, for  $\mu_i(x) \neq 0$  only if  $i = f(\alpha)$  with  $\lambda_\alpha(x) \neq 0$ . Clearly  $\text{Supp } \mu_i \subset U_i$  and  $\sum_i \mu_i(x) = \sum_\alpha \lambda_\alpha(x) \equiv 1$ .

The following theorem, one of the basic tools of differential topology, is frequently used to reduce global theorems to local form. There can be no similar theorem for analytic maps, which is why they are so much harder to handle.

**2.1. Theorem.** *Let  $M$  be a  $C^r$  manifold,  $0 \leq r \leq \infty$ . Every open cover of  $M$  has a subordinate  $C^r$  partition of unity.*

*Proof.* Let  $\mathcal{U} = \{U_i\}_{i \in I}$  be an open cover of  $M$ . There is a locally finite atlas on  $M$ ,  $\{\varphi_\alpha, V_\alpha\}_{\alpha \in A}$  such that  $\{V_\alpha\}_{\alpha \in A}$  refines  $\mathcal{U}$ ; and we may assume that each  $\varphi_\alpha(V_\alpha) \subset \mathbb{R}^n$  is bounded and each  $V_\alpha \subset M$  is compact. There is a shrinking  $\{W_\alpha\}_{\alpha \in A}$  of  $\mathcal{V} = \{V_\alpha\}_{\alpha \in A}$ , and each  $\bar{W}_\alpha \subset V_\alpha$  is compact. It suffices to find a  $C^r$  partition of unity subordinate to  $\mathcal{V}$ .

For each  $\alpha \in A$ , cover the compact set  $\varphi_\alpha(\bar{W}_\alpha) \subset \mathbb{R}^n$  by a finite number of closed balls

$$B(x,1), \dots, B(x,k(x))$$

contained in  $\varphi_\alpha(V_\alpha)$ . Choose  $C^\infty$  maps

$$\lambda_{\alpha,j}: \mathbb{R}^n \rightarrow [0,1], \quad j = 1, \dots, k(x),$$



such that

$$\lambda_{\alpha,j}(x) > 0 \quad \text{if and only if} \quad x \in \text{Int } B(\alpha,j).$$

Put

$$\lambda_{\alpha} = \sum_{j=1}^{k(x)} \lambda_{\alpha,j}: \mathbb{R}^n \rightarrow [0, \infty).$$

Then

$$\begin{aligned} \lambda_{\alpha}(x) &> 0 && \text{if } x \in \varphi_{\alpha}(\bar{W}_{\alpha}), \\ \lambda_{\alpha}(x) &= 0 && \text{if } x \in \mathbb{R}^n - \bigcup_j B(\alpha,j). \end{aligned}$$

Put

$$\mu_{\alpha}: M \rightarrow [0, \infty),$$

$$\mu_{\alpha}(x) = \begin{cases} \lambda_{\alpha}(\varphi_{\alpha}(x)) & \text{if } x \in V_{\alpha} \\ 0 & \text{if } x \in M - V_{\alpha}. \end{cases}$$

Then  $\mu_{\alpha}$  is  $C^r$ ,  $\mu_{\alpha} > 0$  on  $\bar{W}_{\alpha}$ , and  $\text{Supp } \mu_{\alpha} \subset V_{\alpha}$ . Define  $\nu_{\alpha} = \mu_{\alpha} / \sum_{\alpha} \mu_{\alpha}$ . Then  $\{\nu_{\alpha}\}_{\alpha \in A}$  is a  $C^r$  partition of unity subordinate to  $\mathcal{V}$ .

QED

A partition of unity is used to glue together locally defined maps into  $\mathbb{R}^n$  to make a globally defined map. For instance, if  $\{\lambda_i\}_{i \in A}$  is a  $C^s$  partition of unity subordinate to an open cover  $\{U_i\}_{i \in A}$  of  $M$ , and  $g_i: U_i \rightarrow \mathbb{R}^n$  is  $C^s$  for each  $i$ , we can define

$$\begin{aligned} g: M &\rightarrow \mathbb{R}^n, \\ g(x) &= \sum \lambda_i(x) g_i(x), \end{aligned}$$

summed over  $\{i \in A: x \in U_i\}$ . This is a well-defined  $C^s$  map since each  $x$  has an open neighborhood on which  $\lambda_i = 0$  except for finitely many  $i$ .

The following theorem shows how the condition  $\sum_i \lambda_i = 1$  can be used to obtain approximations.

**2.2. Theorem.** *Let  $M$  be a  $C^s$  manifold,  $1 \leq s \leq \infty$ . Then  $C^s(M, \mathbb{R}^n)$  is dense in  $C^0_s(M, \mathbb{R}^n)$ .*

*Proof.* Let  $\{V_{\alpha}\}_{\alpha \in A}$  be a locally finite open cover of  $M$  and for each  $\alpha \in A$  let  $\varepsilon_{\alpha} > 0$ . Let  $f: M \rightarrow \mathbb{R}^n$  be continuous, and suppose we want a  $C^s$  map  $g$  to satisfy  $|f - g| < \varepsilon_{\alpha}$  on  $V_{\alpha}$  for all  $\alpha$ . For each  $x \in M$  let  $W_x \subset M$  be a neighborhood of  $x$  meeting only finitely many  $V_{\alpha}$ . Set

$$\delta_x = \min \{\varepsilon_{\alpha}: x \in V_{\alpha}\} > 0.$$

Let  $U_x \subset W_x$  be an open neighborhood of  $x$  so small that

$$|f(y) - f(x)| < \delta_x, \quad y \in U_x.$$

Define constant maps

$$\begin{aligned} g_x: M &\rightarrow \mathbb{R}^n, \\ g_x(y) &= f(x). \end{aligned}$$

Relabeling the cover  $\{U_x\}$  and the maps  $\{g_x\}$ , we have shown: there is an

open cover  $\{U_i\}_{i \in A} = \mathcal{U}$  of  $M$  and  $C^s$  maps  $g_i: M \rightarrow \mathbb{R}^n$ , such that whenever  $y \in U_i \cap V_{\alpha}$ , then

$$|g_i(y) - f(y)| < \varepsilon_{\alpha}.$$

Let  $\{\lambda_i\}_{i \in A}$  be a  $C^s$  partition of unity subordinate to  $\mathcal{U}$ . Define

$$\begin{aligned} g: M &\rightarrow \mathbb{R}^n, \\ g(y) &= \sum_i \lambda_i(y) g_i(y). \end{aligned}$$

Then  $g$  is  $C^s$  and

$$|g(y) - f(y)| = |\sum \lambda_i(y) g_i(y) - \sum \lambda_i(y) f(y)| \leq \sum \lambda_i(y) |g_i(y) - f(y)|.$$

Hence if  $y \in V_{\alpha}$ ,

$$|g(y) - f(y)| < \sum \lambda_i(y) \varepsilon_{\alpha} = \varepsilon_{\alpha}.$$

QED

Our next task is to approximate  $C^r$  maps by  $C^s$  maps,  $s > r \geq 1$ , in the strong  $C^r$  topology. The preceding argument will not work now because the derivatives of the  $\lambda_i$  are involved. We need to uniformly approximate  $f|_{U_i}$  not by constants, but by  $C^r$  maps whose derivatives up to order  $r$  uniformly approximate those of  $f$ . For maps defined on open subsets of  $\mathbb{R}^n$  we achieve this by the technique of convolution, discussed next.

Let  $\theta: \mathbb{R}^m \rightarrow \mathbb{R}$  be a map having compact support. There is a smallest  $\sigma \geq 0$  such that  $\text{Supp } \theta$  is contained in the closed ball  $B_{\sigma}(0) \subset \mathbb{R}^m$  of radius  $\sigma$  and center 0. We call  $\sigma$  the *support radius* of  $\theta$ .

Let  $U \subset \mathbb{R}^m$  be open and  $f: U \rightarrow \mathbb{R}^n$  a map. If  $\theta: \mathbb{R}^m \rightarrow \mathbb{R}$  has compact support we define the *convolution of  $f$  by  $\theta$*  to be the map

$$\theta * f: U_{\sigma} \rightarrow \mathbb{R}^n$$

given by

$$(1) \quad \theta * f(x) = \int_{B_{\sigma}(0)} \theta(y) f(x - y) dy \quad (x \in U_{\sigma})$$

where

$$U_{\sigma} = \{x \in U: B_{\sigma}(x) \subset U\}.$$

The integral is the Lebesgue integral,  $dy$  denoting the usual measure on  $\mathbb{R}^m$ .

The integrand in (1) is 0 on the boundary of  $B_{\sigma}(0)$ ; we extend it to a continuous map  $\mathbb{R}^m \rightarrow \mathbb{R}$  by defining it to be 0 outside  $B_{\sigma}(0)$ . Therefore we have

$$(2) \quad \theta * f(x) = \int_{\mathbb{R}^m} \theta(y) f(x - y) dy \quad (x \in U_{\sigma}).$$

For a fixed  $x \in U_{\sigma}$  we make the measure preserving change of variable in (1):  $z = x - y$ . Then

$$(3) \quad \begin{aligned} \theta * f(x) &= \int_{B_{\sigma}(x)} \theta(x - z) f(z) dz \\ &= \int_{\mathbb{R}^m} \theta(x - z) f(z) dz \quad (x \in U_{\sigma}) \end{aligned}$$

where again the integrand is defined to be 0 outside  $B_{\sigma}(x)$ .

A map  $\theta: \mathbb{R}^m \rightarrow \mathbb{R}$  is called a *convolution kernel* if it is nonnegative, has compact support, and  $\int_{\mathbb{R}^m} \theta = 1$ . It is clear that there exist  $C^\infty$  convolution kernels of any given support radius.

We may think of  $\theta * f(x)$  as a weighted average of the values of  $f$  near  $x$ . This makes it plausible that  $\theta * f$  will be an approximation to  $f$  which will be smooth if  $\theta$  is smooth.

We introduce the notation

$$\|f\|_{r,K} = \sup \{ \|D^k f(x)\| : x \in K, 0 \leq k \leq r \}$$

if  $f: U \rightarrow \mathbb{R}^n$  is  $C^r$ ,  $U \subset \mathbb{R}^m$  is open,  $K \subset U$  is any subset, and  $\|D^k f(x)\|$  is the norm of the  $k$ 'th derivative of  $f$  at  $x$ . Here  $\|D^0 f(x)\|$  means  $|f(x)|$ , while for  $k > 0$  the  $k$ 'th derivative at  $x$  is a  $k$ -linear map from  $\mathbb{R}^m$  to  $\mathbb{R}^n$ . The norm  $\|S\|$  of any  $k$ -linear map

$$S: \mathbb{R}^m \times \cdots \times \mathbb{R}^m \rightarrow \mathbb{R}^n$$

is defined to be the maximum of  $|S(x_1, \dots, x_k)|$  where the vectors  $x_1, \dots, x_k$  vary over the unit sphere in  $\mathbb{R}^m$ . The value  $\infty$  is allowed for  $\|f\|_{r,K}$ . If  $K$  is the entire domain of  $f$  we write simply  $\|f\|_r$ . Note that for all  $y_1, \dots, y_k$  in  $\mathbb{R}^m$ :

$$|S(y_1, \dots, y_k)| \leq \|S\| \cdot |y_1| \cdots |y_k|.$$

We have the following basic result:

**2.3. Theorem.** Let  $\theta: \mathbb{R}^m \rightarrow \mathbb{R}$  have support radius  $\sigma > 0$ . Let  $U \subset \mathbb{R}^m$  be an open set, and  $f: U \rightarrow \mathbb{R}^n$  a continuous map. The convolution  $\theta * f: U_\sigma \rightarrow \mathbb{R}^n$  has the following properties:

(a) If  $\theta \in \text{Int Supp } \theta$  is  $C^k$ ,  $1 \leq k \leq \infty$ , then so is  $\theta * f$ ; and for each finite  $k$ ,

$$D^k(\theta * f)_x(Y_1, \dots, Y_k) = \int_{\mathbb{R}^m} D^k \theta(x - z)(Y_1, \dots, Y_k) f(z) dz$$

on  $U_\sigma$ .

(b) If  $f$  is  $C^k$  then

$$D^k(\theta * f) = \theta * (D^k f).$$

(c) Suppose  $f$  is  $C^r$ ,  $0 \leq r \leq \infty$ . Let  $K \subset U$  be compact. Given  $\varepsilon > 0$  there exists  $\sigma > 0$  such that  $K \subset U_\sigma$ , and if  $\theta$  is a  $C^r$  convolution kernel of support radius  $\sigma$ , then  $\theta * f$  is  $C^r$  and

$$\|\theta * f - f\|_{r,K} < \varepsilon.$$

*Proof.* To prove (b), observe that the domain of integration in (1) can be restricted to  $\text{Int Supp } \theta$ ; the integrand is then differentiable in  $x$ , and (b) follows by induction on  $k$  and differentiating under the integral sign. (a) is proved similarly using (3). To prove (c) it suffices to take  $r = 0$ , by (b). Since  $d(K, \mathbb{R}^m - U) > 0$ , we can choose  $\sigma$  so small that  $K \subset U_\sigma$ . By uniform continuity of  $f$  on a compact neighborhood of  $K$ , we can choose  $\sigma$  so small that if  $x \in K$  and  $|x - y| \leq \sigma$  then  $|f(x) - f(y)| < \varepsilon$ .

Since

$$\int_{\mathbb{R}^m} \theta = 1$$

we have, integrating over  $\mathbb{R}^m$ :

$$\begin{aligned} |\theta * f(x) - f(x)| &= \left| \int \theta(y)(f(x-y) - f(x)) dy \right| \\ &\leq \int \theta(y) |f(x-y) - f(x)| dy \\ &\leq \varepsilon \int \theta(y) dy = \varepsilon. \end{aligned}$$

QED

From Theorem 2.3 it immediately follows that a  $C^r$  map from open subset of  $\mathbb{R}^m$  to  $\mathbb{R}^n$  can be  $C^r$  approximated by  $C^\infty$  maps in neighborhoods of compact sets. Using partitions of unity we prove the following stronger approximation theorem:

**2.4. Theorem.** Let  $U \subset \mathbb{R}^m$  and  $V \subset \mathbb{R}^n$  be open sets. Then  $C^\infty(U, V)$  is dense in  $C_r^\infty(U, V)$ ,  $0 \leq r < \infty$ .

*Proof.* Since  $C_r^\infty(U, V)$  is open in  $C_r^\infty(U, \mathbb{R}^n)$ , it suffices to prove the theorem with  $V = \mathbb{R}^n$ .

Let  $f \in C^r(U, \mathbb{R}^n)$ . A neighborhood base at  $f$  in  $C_r^\infty(U, \mathbb{R}^n)$  consists of sets  $\mathcal{N}(f, K, \varepsilon)$  of the following form (see Exercise 12, Section 2.1). Let  $K = \{K_i\}_{i \in A}$  be a locally finite family of compact subsets of  $U$ ; let  $\varepsilon = \{\varepsilon_i\}_{i \in A}$  be a family of positive numbers, and let  $\mathcal{N}(f, K, \varepsilon)$  be the set of  $C^r$  maps  $g: U \rightarrow \mathbb{R}^n$  such that for all  $i \in A$

$$(4) \quad \|g - f\|_{r, K_i} < \varepsilon_i.$$

Fixing  $f, K$  and  $\varepsilon$ , we must show

$$C^\infty(U, \mathbb{R}^n) \cap \mathcal{N}(f, K, \varepsilon) \neq \emptyset.$$

Let  $\{\lambda_i\}_{i \in A}$  be a  $C^\infty$  partition of unity on  $U$  such that  $\text{Supp } \lambda_i$  is compact and  $K_i \subset \text{Int}(\text{Supp } \lambda_i)$ .

Given positive numbers  $\{\alpha_i\}_{i \in A}$  there are  $C^\infty$  maps  $g_i: U_i \rightarrow \mathbb{R}^n$  such that for  $x \in K_i$  and  $k = 0, \dots, r$ ,

$$\|g_i - f\|_{r, K_i} < \alpha_i.$$

Put

$$g: U \rightarrow \mathbb{R}^n$$

$$g(x) = \sum_i \lambda_i(x) g_i(x).$$

Then  $g$  is  $C^\infty$ . To estimate  $\|D^k g(x) - D^k f(x)\|$  we observe that if  $\lambda: U \rightarrow \mathbb{R}$  and  $\varphi: U \rightarrow \mathbb{R}^n$  are  $C^k$  and  $\psi(x) = \lambda(x)\varphi(x)$ , then  $D^k \psi(x)$  is a sum of bilinear functions of  $D^p \lambda(x)$ ,  $D^q \varphi(x)$ ,  $p, q = 0, \dots, k$ ; this bilinear function is universal and independent of  $x, \lambda$  and  $\varphi$ . Thus there is a universal constant  $A_k > 0$  such that

$$\|D^k(\lambda\varphi)(x)\| \leq A_k \max_{0 \leq p \leq k} \|D^p \lambda(x)\| \cdot \max_{0 \leq q \leq k} \|D^q \varphi(x)\|.$$

Set

$$A = \max \{A_0, \dots, A_r\}.$$

Fix  $i \in A$  and set

$$A_i = \{j \in A: K_i \cap K_j \neq \emptyset\}.$$

This is a finite set; let its cardinality be  $m_i$ . Put

$$\begin{aligned}\mu_i &= \max \{ \|\lambda_j\|_{r, \kappa_i} : j \in A_i \} \\ \beta_i &= \max \{ \alpha_j : j \in A_i \}.\end{aligned}$$

In the following sums  $j$  varies over  $A_i$ . For  $x \in K_i$  and  $0 \leq k \leq r$  we have

$$\begin{aligned}\|D^k g(x) - D^k f(x)\| &= \left\| \sum_j D^k(\lambda_j g_j - \lambda_j f)(x) \right\| \\ &\leq \sum_j \|D^k(\lambda_j(g_j - f))(x)\| \leq m_i A \mu_i \beta_i.\end{aligned}$$

It is clear that the numbers  $\alpha_i$  can be chosen so that

$$m_i A \mu_i \beta_i < \varepsilon_i.$$

With this choice of  $\alpha_i$  we have, for all  $i \in A$ ,

$$\|g - f\|_{r, \kappa_i} < \varepsilon_i.$$

QED

A refinement of Theorem 2.4 is needed for the globalization to manifolds. Suppose we have a  $C^r$  map  $f: U \rightarrow \mathbb{R}^n$  that we want to approximate by a  $C^r$  map  $h$  which is  $C^s$  in a neighborhood of a (relatively) closed set  $K \subset U$ . At the same time, for technical reasons we want  $h$  to equal  $f$  outside a certain open set  $W \subset U$ ; of course, we must assume  $f$  is already  $C^s$  on a neighborhood of  $K - W$ . The following *relative approximation* theorem ensures that maps such as  $h$  approximate  $f$  arbitrarily closely.

**2.5. Theorem.** *Let  $U \subset \mathbb{R}^m$  and  $V \subset \mathbb{R}^n$  be open subsets, and  $f: U \rightarrow V$  a  $C^r$  map. Let  $K \subset U$  be closed and  $W \subset U$  open, such that  $f$  is  $C^s$  on a neighborhood of  $K - W$ . Then every neighborhood  $\mathcal{N}$  of  $f$  in  $C_S^s(U, V)$  contains a  $C^r$  map  $h: U \rightarrow V$  which is  $C^s$  in a neighborhood of  $K$ , and which equals  $f$  on  $U - W$ .*

*Proof.* We may assume  $V = \mathbb{R}^n$  (see proof of Theorem 2.4). Let  $A \subset U$  be an open set containing the closed set  $K - W$  such that  $f|_A$  is  $C^s$ . Let  $W_0 \subset U$  be open, with

$$K - A \subset W_0 \subset \bar{W}_0 \subset W.$$

Let  $\{\lambda_0, \lambda_1\}$  be a  $C^s$  partition of unity for the open cover  $\{W, U - \bar{W}_0\}$  of  $U$ . Thus  $\lambda_0$  and  $\lambda_1$  are  $C^s$  maps  $U \rightarrow [0, 1]$  such that  $\lambda_0 + \lambda_1 = 1$ ,  $\lambda_0 = 0$  on a neighborhood of  $U - W$  and  $\lambda_1 = 0$  on a neighborhood of  $\bar{W}_0$ .

Define

$$G: C_S^s(U, \mathbb{R}^n) \rightarrow C_S^s(U, \mathbb{R}^n)$$

by

$$G(g)(x) = \lambda_0(x)g(x) + \lambda_1(x)f(x).$$

Then  $G(g) = g$  in  $W_0$  and  $G(g) = f$  in  $U - W$ . Clearly  $G(g)$  is  $C^s$  on every open set on which both  $f$  and  $g$  are  $C^s$ . It is easy to prove  $G$  continuous. Since  $G(f) = f$ , there is an open set  $\mathcal{N}_0 \subset C_S^s(U, \mathbb{R}^n)$  containing  $f$  such that

$G(\mathcal{N}_0) \subset \mathcal{N}$ . By Theorem 2.4 there is a  $C^s$  map  $g \in \mathcal{N}_0$ . Then  $h = G(g)$  has the required properties.

QED

We now prove the basic approximation theorem for manifolds without boundary. Later we shall extend it to  $\partial$ -manifolds and manifold pairs.

**2.6. Theorem.** *Let  $M$  and  $N$  be  $C^s$  manifolds,  $1 \leq s \leq \infty$ . Then  $C^r(M, N)$  is dense in  $C_S^s(M, N)$ ,  $0 \leq r < s$ .*

*Proof.* Let  $f: M \rightarrow N$  be  $C^r$ . Let  $\Phi = \{\varphi_i, U_i\}_{i \in A}$  be a locally finite atlas for  $M$  and  $\Psi = \{\psi_i, V_i\}_{i \in A}$  a family of charts for  $N$  such that for all  $i \in A$ ,  $f(U_i) \subset V_i$ . Let  $L = \{L_i\}_{i \in A}$  be a closed cover of  $M$ ,  $L_i \subset U_i$ . Let  $\varepsilon = \{\varepsilon_i\}_{i \in A}$  be a family of positive numbers, and put  $\mathcal{N} = \mathcal{N}^r(f; \Phi, \Psi, L, \varepsilon) \subset C^r(M, N)$ .

We look for a  $g \in \mathcal{N}$  which is  $C^s$ . The set  $A$  is countable; we therefore assume that  $A = \mathbb{Z}_+$  or, if  $M$  is compact,  $A = \{1, \dots, p\}$ . (We denote the integers by  $\mathbb{Z}$ , the positive integers by  $\mathbb{Z}_+$ , and the natural numbers by  $\mathbb{N} = \mathbb{Z}_+ \cup \{0\}$ .)

Let  $\{W_i\}_{i \in A}$  be a family of open sets in  $M$  such that  $L_i \subset W_i \subset \bar{W}_i \subset U_i$ .

We shall define by induction a family of  $C^r$  maps  $g_k \in \mathcal{N}$ ,  $k \in \mathbb{N}$ , having the following properties:  $g_0 = f$ , and for  $k \geq 1$ :

$$(5)_k \quad g_k = g_{k-1} \text{ on } M - W_k$$

$$(6)_k \quad g_k \text{ is } C^s \text{ in a neighborhood of } \bigcup_{0 \leq j \leq k} L_j.$$

Assuming for the moment that the  $g_k$  exist, define  $g: M \rightarrow N$  by  $g(x) = g_{\kappa(x)}(x)$ , where  $\kappa(x) = \max \{k: x \in U_k\}$ . Each  $x$  has a neighborhood on which  $g = g_{\kappa(x)}$ . This shows that  $g$  is  $C^s$  and  $g \in \mathcal{N}$ , and the theorem is proved.

It remains to construct the  $g_k$ . Put  $g_0 = f$ ; then  $(5)_0$  and  $(6)_0$  are vacuously true. Suppose that  $0 < m$  and that we have maps  $g_k \in \mathcal{N}$ ,  $0 \leq k < m$ , satisfying  $(5)_k$  and  $(6)_k$ .

Define a space of maps

$$\mathcal{G} = \{h \in C_S^s(U_m, V_m) : h = g_{m-1} \text{ on } U_m - W_m\}.$$

Define

$$\begin{aligned}T: \mathcal{G} &\rightarrow C_S^s(M, N), \\ T(h) &= \begin{cases} h & \text{on } U_m \\ g_{m-1} & \text{on } M - U_m. \end{cases}\end{aligned}$$

Then  $T$  is easily proved continuous. Observe that  $T(g_{m-1}|_{U_m}) = g_{m-1}$ . Hence  $T^{-1}(\mathcal{N}) \neq \emptyset$ .

Let  $K = \bigcup_{k \leq m} L_k \cap U_m$ . Then  $K$  is a closed subset of  $U_m$  and  $g_{m-1}: U_m \rightarrow V_m$  is  $C^s$  on a neighborhood of  $K - W_m$ . Since  $U_m$  and  $V_m$  are  $C^s$  diffeomorphic to open subsets of  $\mathbb{R}^m$  and  $\mathbb{R}^n$ , we can apply Theorem 2.5 to  $C_S^s(U_m, V_m)$ . We conclude that the maps in  $\mathcal{G}$  which are  $C^s$  in a neighborhood of  $K$  are dense in  $\mathcal{G}$ . Therefore  $T^{-1}(\mathcal{N})$  contains such a map  $h$ . Define  $g_m = T(h)$ ; then  $g_m \in \mathcal{N}$  satisfies  $(5)_m$  and  $(6)_m$ .

QED

For the following application of Theorem 2.6 let  $G^k(M, N) \subset C^k(M, N)$ ,  $k \geq 1$ , denote any one of the following subsets:

diffeomorphisms,  
embeddings,  
closed embeddings,  
immersions,  
submersions,  
proper maps.

**2.7. Theorem.** Let  $M$  and  $N$  be  $C^s$  manifolds,  $1 \leq s \leq \infty$ . Then  $G^s(M, N)$  is dense in  $G^r(M, N)$  in the strong  $C^r$  topology,  $1 \leq r < s$ . In particular,  $M$  and  $N$  are  $C^s$  diffeomorphic if and only if they are  $C^r$  diffeomorphic.

*Proof.* This follows from Theorem 2.6 and the openness theorems of Section 2.1.

QED

We shall need the following lemma for raising differentiability of manifolds:

**2.8. Lemma.** Let  $U$  be a  $C^r$  manifold,  $0 \leq r < \infty$ , and  $W \subset U$  an open set. Let  $V \subset \mathbb{R}^n$  be open,  $f \in C_s^r(U, V)$ , and put  $f(W) = V'$ . Then there is a neighborhood  $\mathcal{N} \subset C_s^r(W, V')$  of  $f|_W$  such that if  $g_0 \in \mathcal{N}$ , the map

$$T(g_0) = g: U \rightarrow V,$$

$$g = \begin{cases} g_0 & \text{on } W \\ f & \text{on } U - W \end{cases}$$

is  $C^r$ , and  $T: \mathcal{N} \rightarrow C_s^r(U, V)$  is continuous.

*Proof.* Let  $\{\varphi_i, U_i\}_{i \in \Lambda}$  be a locally finite family of charts of  $U$  which cover the boundary  $\text{Bd } W$  of  $W$ . Let  $\{L_i\}_{i \in \Lambda}$  be a family of closed subsets of  $U$  and which cover  $\text{Bd } W$ , with  $L_i \subset U_i$ .

Let  $\mathcal{N} \subset C_s^r(W, V')$  be the set of  $C^r$  maps  $h: W \rightarrow V'$  such that if  $i \in \Lambda$ ,  $y \in \varphi_i(L_i \cap W)$  and  $0 \leq k \leq r$ , then

$$(7) \quad \|D^k(h\varphi_i^{-1})y - D^k(f\varphi_i^{-1})y\| < d(y, \varphi_i(U_i - W)).$$

Then  $\mathcal{N}$  is a neighborhood of  $f|_W$ : by paracompactness  $W$  has a locally finite closed cover  $\{K_\alpha\}$  such that each  $K_\alpha$  meets only finitely many  $L_i$  and on each  $K_\alpha \cap L_i$  the map  $x \mapsto d(\varphi_i(x), \varphi_i(U_i - W))$  is bounded away from 0.

If  $h \in \mathcal{N}$  define

$$T(h) = g: U \rightarrow V,$$

$$g = \begin{cases} h & \text{on } W \\ f & \text{on } U - W. \end{cases}$$

We claim  $g$  is  $C^r$ . It suffices to prove that each map  $\lambda_i = (g - f)\varphi_i^{-1}: \varphi_i(U_i) \rightarrow \mathbb{R}^n$  is  $C^r$ . Now

$$\lambda_i = \begin{cases} h\varphi_i^{-1} - f\varphi_i^{-1} & \text{on } \varphi_i(W) \\ 0 & \text{on } \varphi_i(U_i - W). \end{cases}$$

Obviously  $\lambda_i$  is  $C^r$  on  $\varphi_i(W)$ . By (7), for  $0 \leq k \leq r$ :

$$D^k \lambda_i(y) \rightarrow 0 \quad \text{as} \quad d(y, \varphi_i(U_i - W)) \rightarrow 0,$$

uniformly in  $y \in \varphi_i(W)$ . It follows that  $\lambda_i$  is  $C^r$ , with all derivatives 0 on  $\varphi_i(U_i - W)$ . Therefore  $g$  is  $C^r$  and the map  $T: C^r(W, V') \rightarrow C^r(U, V)$  is well-defined. The continuity of  $T$  is left as an exercise.

QED

Let  $\alpha$  be a  $C^r$  differential structure on a manifold  $M$ . A  $C^s$  differential structure  $\beta$  on  $M$ ,  $s > r$ , is compatible with  $\alpha$  if  $\beta \subset \alpha$ . This means that every chart of  $\beta$  is a chart of  $\alpha$ . Equivalently, it means that the identity map of  $M$  is a  $C^r$  diffeomorphism  $M(\alpha) \rightarrow M(\beta)$ .

**2.9. Theorem.** Let  $\alpha$  be a  $C^r$  differential structure on a manifold  $M$ ,  $r \geq 1$ . For every  $s$ ,  $r < s \leq \infty$ , there exists a compatible  $C^s$  differential structure  $\beta \subset \alpha$ , and  $\beta$  is unique up to  $C^s$  diffeomorphism.

*Proof.* For convenience we shall denote a differential structure and its restriction to an open set by the same symbol. By Zorn's lemma there is a nonempty open set  $B \subset M$  and a  $C^s$  differential structure  $\beta$  on  $B$  which is compatible with  $\alpha$ , and such that  $(B, \beta)$  is maximal in this property. We must prove  $B = M$ .

If  $B \neq M$  there is a chart  $(\varphi, U)$  for  $M$  such that  $U \cap (M - B) \neq \emptyset$ . Put  $\varphi(U) = U' \subset \mathbb{R}^n$ ,  $U \cap B = W$  and  $\varphi(W) = W'$ .

There are now two differential structures on  $W$ : the  $C^r$  structure  $\alpha$  and the compatible  $C^s$  structure  $\beta \subset \alpha$ . We shall find a  $C^r$  diffeomorphism  $\theta: U_\alpha \rightarrow U'$  such that  $\theta|_W: W_\beta \rightarrow W'$  is a  $C^s$  diffeomorphism. In that case the chart  $(\theta, U)$  has  $C^s$  overlap with  $\beta$ ; the  $C^s$  atlas  $\beta \cup (\theta, U)$  on  $B \cup U$  is contained in  $\alpha$  and this contradicts the maximality of  $(B, \beta)$ .

To construct  $\theta$  we use Lemma 2.8 to obtain a neighborhood  $\mathcal{N} \subset C_s^r(W_\beta, W')$  of  $\varphi|_W: W \rightarrow W'$  with the following property. Whenever  $\psi_0 \in \mathcal{N}$ , the map  $T(\psi_0) = \psi: U \rightarrow U'$  defined by

$$\psi = \begin{cases} \psi_0 & \text{on } W \\ \varphi & \text{on } U - W \end{cases}$$

is  $C^r$ , and the resulting map

$$T: C_s^r(W_\beta, W') \rightarrow C_s^r(U, U')$$

is continuous. Since  $T(\varphi|_W)$  is the diffeomorphism  $\varphi$ , there is a neighborhood  $\mathcal{N}_0 \subset \mathcal{N}$  of  $\varphi|_W$  such that  $T(\mathcal{N}_0) \subset \text{Diff}^r(U, U')$ . By the approximation

theorem 2.6 there is a  $C^s$  diffeomorphism  $\theta_0 \in \mathcal{N}_0$ ; the required map  $\theta$  is then  $T(\theta_0)$ .

QED

It is amusing that neither paracompactness nor Hausdorffness of  $M$  was used in the preceding proof; these properties were needed only for the coordinate domain  $U$ .

From Theorems 2.7 and 2.9 we obtain a fundamental result:

### 2.10. Theorem.

(a) Let  $1 \leq r < \infty$ . Every  $C^r$  manifold is  $C^r$  diffeomorphic to a  $C^\infty$  manifold.

(b) Let  $1 \leq r < s \leq \infty$ . If two  $C^s$  manifolds are  $C^r$  diffeomorphic, they are  $C^s$  diffeomorphic.

In view of this there is no need to consider  $C^r$  manifolds for  $1 \leq r < \infty$ ; and for most purposes  $C^\infty$  maps are sufficient. The  $C^\infty$  category has several advantages over the  $C^r$  categories with  $r$  finite. An obvious one is its closure under derivatives. A more subtle advantage comes from the Morse–Sard theorem in the following chapter.

Earlier we pointed out the theme of *globalization* that runs through many proofs. There is an abstract aspect of the passage from local to global which, if recognized, can often make a proof obvious; at the least, it provides a clear strategy for the proof. Since we shall need to globalize several more times, it is worthwhile to formalize the pattern of proof in the following way.

Let  $X$  be a set and  $\mathfrak{Y}$  a family of subsets. We assume that  $X \in \mathfrak{Y}$  and that the union of any collection of elements of  $\mathfrak{Y}$  is again in  $\mathfrak{Y}$ . (In practice  $X$  is a manifold and  $\mathfrak{Y}$  is generated by the elements in an open cover, or a locally finite closed cover.) Suppose we have a contravariant functor from the partially ordered (by inclusion) set  $\mathfrak{Y}$  to the category of sets. That is, to every  $A \in \mathfrak{Y}$  there is associated a set  $\mathcal{F}(A)$ , and to every pair of sets  $A, B \in \mathfrak{Y}$  with  $A \subset B$  there is assigned a map of sets  $\mathcal{F}_{AB}: \mathcal{F}(B) \rightarrow \mathcal{F}(A)$ , denoted by  $x \mapsto x|_A$ , where  $x \in \mathcal{F}(B)$  such that  $\mathcal{F}_{AB}\mathcal{F}_{BC} = \mathcal{F}_{AC}$  whenever  $A \subset B \subset C$ , and  $\mathcal{F}_{AA} =$  identity map of  $\mathcal{F}(A)$ .

We call  $(\mathcal{F}, \mathfrak{Y})$  a *structure functor* on  $X$ . An element of  $\mathcal{F}(A)$  is thought of as a “structure” of some kind on  $A$  for which “restriction” to subsets of  $A$  makes sense. We wish to prove that  $X$  has a structure, that is,  $\mathcal{F}(X) \neq \emptyset$ .

A structure functor is *continuous* if the following holds. If  $\{Y_\alpha\}$  is any simply ordered family of elements of  $\mathfrak{Y}$ , and  $\cup Y_\alpha = Y$ , then the inverse limit of the maps  $\mathcal{F}_{Y_\alpha Y}: \mathcal{F}(Y) \rightarrow \mathcal{F}(Y_\alpha)$  is a map  $\mathcal{F}(Y) \rightarrow \text{inv lim } \mathcal{F}(Y_\alpha)$  which is bijective.

A structure functor is *locally extendable* if every point of  $X$  belongs to a set  $V \in \mathfrak{Y}$  such that for all  $Y \in \mathfrak{Y}$  the map

$$\mathcal{F}_{Y, Y \cup V}: \mathcal{F}(Y \cup V) \rightarrow \mathcal{F}(Y)$$

is surjective. It is called *nontrivial* if  $\mathcal{F}(Y) \neq \emptyset$  for some  $Y \in \mathfrak{Y}$ .

As an example, let  $X$  be a  $C^r$  manifold,  $0 \leq r < \infty$ , and  $\mathfrak{Y}$  the family of all open sets. Let  $\mathcal{F}(Y)$  be the set of compatible  $C^s$  differential structures on  $Y$  for some  $s > r$ . Clearly  $(\mathcal{F}, \mathfrak{Y})$  is a structure functor which is nontrivial and continuous. If  $1 \leq r < s \leq \infty$  then  $\mathcal{F}$  is locally extendable, as was shown in the proof of Theorem 2.9.

For another example, let  $X \subset \mathbb{R}^n$  be a nonnull open set. Let  $\mathfrak{Y}$  be generated by a locally finite cover of  $X$  by compact sets. Let  $\mathcal{F}(Y)$  be the set of  $Y$ -germs of analytic maps into  $\mathbb{R}$ ; a *Y-germ* is an equivalence class of maps defined in neighborhoods of  $Y$ , two maps being equivalent if they agree in some neighborhood of  $Y$ . Then  $(\mathcal{F}, \mathfrak{Y})$  is continuous and nontrivial, but is not locally extendable.

**2.11. Globalization Theorem.** Let  $(\mathcal{F}, \mathfrak{Y})$  be a nontrivial structure functor on  $X$  which is continuous and locally extendable. Then  $\mathcal{F}(X) \neq \emptyset$ . In fact if  $\mathcal{F}(Y_0) \neq \emptyset$  then  $\mathcal{F}(X) \rightarrow \mathcal{F}(Y_0)$  is surjective.

*Proof.* Let  $a_0 \in \mathcal{F}(Y_0)$ . Let  $S$  be the set of pairs  $(Y, a)$  with  $Y_0 \subset Y \in \mathfrak{Y}$  and  $a \in \mathcal{F}(Y)$ ,  $a|_{Y_0} = a_0$ . Partially order  $S$  by  $(Y', a') \leq (Y, a)$  if  $Y' \subset Y$  and  $a|_{Y'} = a'$ . By the closure of  $\mathfrak{Y}$  under union and the continuity axiom,  $S$  has a maximal element  $(Y^*, a^*)$ .

We claim  $Y^* = X$ . If not, by local extendability there exists  $V \in \mathfrak{Y}$  and  $b \in \mathcal{F}(Y^* \cup V)$  such that  $b|_{Y^*} = a^*$ . But then  $(Y^* \cup V, b) > (Y^*, a^*)$ , contradicting maximality. Hence  $Y^* = X$ .

QED

This method is often convenient for proving the existence of a global structure when local existence and extendability are known: Theorem 2.9 is an example. Another example is:

**2.12. Theorem.** Let  $M, N$  be  $C^r$  manifolds,  $1 \leq r \leq \infty$ . If  $\dim N \geq 2 \dim M$  then immersions are dense in  $C^r_5(M, N)$ .

*Proof.* It is convenient to assume  $r = 2$ . This is no restriction, for if  $r < 2$ , every  $C^1$  manifold has a compatible  $C^2$  structure, and if  $r > 2$  every  $C^2$  immersion can be approximated by  $C^r$  immersions. Henceforth we assume all maps are  $C^2$ .

Let  $f_0: M \rightarrow N$  be a map and  $\mathcal{N}_0 \subset C^2_5(M, N)$  a neighborhood of  $f_0$ . There is a smaller neighborhood  $\mathcal{N} \subset \mathcal{N}_0$  of  $f_0$  of the following form:

$$\mathcal{N} = \mathcal{N}^2(f_0; \Phi, \Psi, K, \varepsilon)$$

where

$$\Psi = \{\psi_i: V_i \rightarrow \mathbb{R}^m\}_{i \in I}$$

is a family of charts on  $N$ ;

$$\Phi = \{\varphi_i: U_i \rightarrow \mathbb{R}^m\}_{i \in I}$$

is a locally finite atlas for  $M$  with  $f_0(U_i) \subset V_i$ ;  $K = \{K_i\}_{i \in I}$ , where  $K_i \subset U_i$ ;

$$\varphi_i(K_i) = D^m \subset \mathbb{R}^m;$$

and  $\varepsilon = \{\varepsilon_i\}_{i \in I}$  is a set of positive numbers.

We now define a structure functor  $(\mathcal{F}, \mathfrak{Y})$ . For  $\mathfrak{Y}$  we take the family of all unions of the disks  $K_i$ , partially ordered by inclusion. If  $A \in \mathfrak{Y}$  we define  $\mathcal{F}(A)$  to be the set of  $A$ -germs of maps  $f \in \mathcal{N}$  such that  $f$  is an immersion of some open set containing  $A$ . If  $A \subset B$ , every such  $B$ -germ is contained in a unique  $A$ -germ; this correspondence defines the map  $\mathcal{F}_{AB}: \mathcal{F}(B) \rightarrow \mathcal{F}(A)$ .

It is easy to see that  $(\mathcal{F}, \mathfrak{Y})$  is continuous. Moreover, it is locally extendable. To see this let  $W \subset M$  be an open neighborhood of  $A \in \mathfrak{Y}$ , and let  $f \in \mathcal{N}$  be a map such that  $f|_W$  is an immersion. Then  $f$  represents an  $A$ -germ  $\alpha \in \mathcal{F}(A)$ . If  $A \neq M$  pick  $K_i \not\subset A$ . To extend  $\alpha$  over  $A \cup K_i$  is to find a map  $g \in \mathcal{N}$  which agrees with  $f$  in some neighborhood of  $A$ , and which is an immersion of a neighborhood of  $A \cup K_i$ . This is done as follows.

Let  $B \subset U_i$  be a disk whose interior contains  $K_i$ . Now  $f(B) \subset V_i$ , and  $V_i$  is diffeomorphic to an open set in  $\mathbb{R}^n$ ,  $n \geq 2 \dim M$ . Therefore by Theorem 1.1  $f|_B: B \rightarrow V_i$  can be  $C^2$  approximated by immersions.

Let  $\lambda: M \rightarrow [0, 1]$  equal 0 on an open neighborhood  $Z$  of  $A \cup (M - \text{int } B)$ , and 1 on an open neighborhood  $Y$  of  $K_i - W$ . For each immersion  $g: B \rightarrow V_i$  define a map  $S(g): M \rightarrow N$  by

$$S(g)x = \begin{cases} f(x) & \text{if } x \in M - B \\ (1 - \lambda(x))f(x) + \lambda(x)g(x) & \text{if } x \in B. \end{cases}$$

Here we have identified  $V_i$  with an open set in  $\mathbb{R}^n$  via  $\psi_i$ . The map

$$S: C_S^2(B, V_i) \rightarrow C_S^2(M, N)$$

is continuous, and

$$\begin{aligned} S(f|_B) &= f, \\ S(g) &= f \quad \text{on } Z \\ S(g) &= g \quad \text{on } Y. \end{aligned}$$

From the first equation it follows that  $S(g) \in \mathcal{N}$  if  $g$  is sufficiently near  $f|_B$ . The second equation implies that  $S(g)$  and  $f$  have the same  $A$ -germ. The third equation implies that  $S(g)$  is an immersion on  $Y$ . But in fact  $S(g)$  is an immersion of a neighborhood of  $K_i$  if  $g$  is sufficiently near  $f|_B$ . For let  $X$  be a neighborhood of  $K_i - Y$  with  $\bar{X}$  compact in  $W$ . Since  $f|_W$  is an immersion and  $\bar{X} \subset W$  is compact,  $f$  has a neighborhood  $\mathcal{N}_1$  such that  $h|_X$  is an immersion if  $h \in \mathcal{N}_1$ . If  $g$  is close enough to  $f$  then  $S(g) \in \mathcal{N}_1$  and so  $S(g)|_X$  is an immersion. Such an  $S(g)$  is thus an immersion of a neighborhood of  $A \cup K_i$ . This proves that  $(\mathcal{F}, \mathfrak{Y})$  is locally extendable. By Theorem 2.11,  $\mathcal{F}(M) \neq \emptyset$ , that is,  $\mathcal{N}$  contains an immersion.

Another proof of Theorem 2.12 is given at the end of Section 3.2.

QED

If  $M$  is not compact then embeddings may not be dense in  $C_S^r(M, N)$ , no matter what the dimensions of  $M, N$ . For example let  $f: \mathbb{Z} \rightarrow \mathbb{R}^n$  be a map of the integers whose image is the set of points having rational coordinates.

Let  $g: \mathbb{Z} \rightarrow \mathbb{R}^n$  be any map such that

$$|g(n) - f(n)| < \frac{1}{|n|}$$

for  $n \neq 0$ . Then the image of  $g$  is dense, so  $g(\mathbb{Z})$  is not discrete; hence  $g$  is not an embedding.

The difficulty is trying to imitate the proof of Theorem 2.12 for embeddings is that if  $M$  is not compact the structure functor defined by  $A$ -germs of embeddings is not continuous. It is continuous, however, when  $M$  is compact; and if  $\dim N \geq 2 \dim M + 1$  it can be proved locally extendable. More generally, if the neighborhood  $\mathcal{N} \subset C_S^r(M, N)$  consists of proper maps, then the structure functor of  $A$ -germs of maps in  $\mathcal{N}$  which are embeddings in a neighborhood of  $A$  is continuous, and locally extendable if  $\dim N \geq 2 \dim M + 1$ . In this way one obtains a proof of the following result; the details are left as an exercise:

**2.13. Theorem.** *Let  $M, N$  be  $C^r$  manifolds,  $1 \leq r \leq \infty$ , with  $\dim N \geq 2 \dim M + 1$ . If  $M$  is compact then embeddings are dense in  $C_S^r(M, N)$ . If  $M$  is not compact, embeddings are dense in  $\text{Prop}_S^r(M, N)$ .*

As a corollary we have the following result of Whitney:

**2.14. Theorem.** *Every  $C^r$   $n$ -dimensional manifold,  $1 \leq r \leq \infty$ , is  $C^r$  diffeomorphic to a closed submanifold of  $\mathbb{R}^{2n+1}$ .*

*Proof.* This follows from Theorem 2.13 as soon as a proper map  $f: M \rightarrow \mathbb{R}$  has been found. If  $M$  is compact take  $f$  constant. If  $M$  is not compact, let  $M_1 \subset M_2 \subset \dots$  be an increasing family of compact sets which fill up  $M$ , with  $M_k \subset \text{Int } M_{k+1}$ .

Let

$$f(M_{2k+1} - M_{2k}) = 2k + 1, \quad k \geq 1$$

and extend  $f$  to a continuous map sending  $M_{2k} - M_{2k-1}$  into  $[2k - 1, 2k + 1]$  using Tietze's theorem. Then  $f$  is proper.

QED

We return to Theorem 2.13 in Section 2.4.

### Exercises

- \*1. (a) Let  $X \subset M$  be a closed subset of a  $C^r$  manifold,  $0 \leq r \leq \infty$ . Then there exists a  $C^r$  map  $f: M \rightarrow [0, \infty)$  with  $X = f^{-1}(0)$ .
  - (b) If  $X, Y$  are disjoint closed subsets of a  $C^r$  manifold  $M$ ,  $0 \leq r \leq \infty$ , there is a  $C^r$  map  $\lambda: M \rightarrow [0, 1]$  with  $\lambda^{-1}(0) = X, \lambda^{-1}(1) = Y$ .
2. Any two points in a connected  $C^r$  manifold,  $0 \leq r \leq \infty$ , can be joined by a  $C^r$  path  $f: [0, 1] \rightarrow M$ , and for  $r \geq 1$ ,  $f$  can be chosen to be an embedding. (This is also true, but difficult, for  $r = \omega$ .)

3. Let  $p: M \rightarrow N$  be a  $C^r$  map and  $f: N \rightarrow M$  a  $C^r$  section of  $p$  (that is,  $pf = 1_N$ ).
- (a) If  $1 \leq r < s \leq \infty$  then  $f$  can be  $C^r$  approximated by  $C^s$  sections. In fact if  $g$  is sufficiently  $C^r$  close to  $f$  then  $g(N)$  is the image of a section.
- (b) If  $0 = r < s \leq \infty$  and  $p$  is submersive, then  $f$  can be  $C^r$  approximated by  $C^s$  sections.
4. There are relative versions of theorems 2.6, 2.9, 2.12, and 2.13.
5. What are the bilinear functions  $A_k$  in the proof of Theorem 2.4?

### 3. Approximations on $\partial$ -Manifolds and Manifold Pairs

In this section we extend the approximation results of Section 2.2 to  $\partial$ -manifolds and manifold pairs.

In constructing a  $C^\infty$  differential structure for a  $C^r$   $\partial$ -manifold, one needs to know that a  $C^r$  map  $f: (M, \partial M) \rightarrow (N, \partial N)$  can be approximated by  $C^\infty$  maps. Thus we are led to consider the space  $C_s^r(M, \partial M; N, \partial N)$  of  $C^r$  maps  $f: M \rightarrow N$  such that  $f(\partial M) \subset \partial N$ , with the strong topology. More generally we consider  $C_s^r(M, M_0; N, N_0)$ , where  $M_0 \subset M$  and  $N_0 \subset N$  are closed neat  $C^r$  submanifolds.

The proofs are quite close to those of Section 2.2. The main change is an adaptation of the approximation Theorem 2.4 to pairs. The details of this are given for  $\partial$ -manifolds; other proofs are omitted.

The definition of  $\|f\|_{r,K}$ , where now  $f$  is defined on an open subset of a halfspace, is the same as before.

**3.1. Lemma.** *Let  $E \subset \mathbb{R}^m$  and  $F \subset \mathbb{R}^n$  be halfspaces,  $U \subset E$  an open subset, and  $f: U \rightarrow F$  a  $C^r$  map,  $0 \leq r < \infty$ . Let  $K \subset U$  be compact and  $\varepsilon > 0$ . There is an open neighborhood  $U' \subset U$  of  $K$  and a  $C^\infty$  map  $g: U' \rightarrow F$  such that  $\|g - f\|_{r,U'} < \varepsilon$ . Moreover, if  $X \subset \partial U$  is such that  $f(X) \subset \partial F$ , then  $g$  can be chosen so that  $g(X \cap U') \subset \partial F$ .*

*Proof.* We may assume that either  $\partial U$  or  $\partial F$  is nonempty, for if both are empty Theorem 3.1 is subsumed by previous results. If  $\partial U = \emptyset$ , first approximate  $f$  by a map

$$f_0(x) = f(x) + y$$

where  $y \in F - \partial F$  has norm  $< \varepsilon$ ; then apply 2.4.

If  $\partial U \neq \emptyset$  but  $\partial F = \emptyset$ , extend  $f$  to a  $C^r$  map on an open neighborhood of  $V$  in  $\mathbb{R}^n$ , using local extensions and  $C^r$  partitions of unity, and apply 2.4.

If both  $\partial U$  and  $\partial F$  are nonempty, make the natural identifications:

$$\begin{aligned} \mathbb{R}^m &= (\partial E) \times \mathbb{R}, & E &= (\partial E) \times [0, \infty); \\ \mathbb{R}^n &= (\partial F) \times \mathbb{R}, & F &= (\partial F) \times [0, \infty). \end{aligned}$$

For  $(x, y) \in (\partial E) \times \mathbb{R}$  write

$$f(x, y) = (f_0(x, y), f_1(x, y)) \in \partial F \times [0, \infty).$$

Note that  $f_1 \geq 0$ .

We use a variation of the convolution of Section 2.1. Let  $\theta: \mathbb{R}^m \rightarrow \mathbb{R}$  be a  $C^\infty$  convolution kernel of the special form

$$\theta(x, y) = \alpha(x)\beta(y)$$

where  $\alpha: \partial E \rightarrow \mathbb{R}$ ,  $\beta: \mathbb{R} \rightarrow \mathbb{R}$  are  $C^\infty$  convolution kernels.

Suppose  $\alpha$ ,  $\beta$  and  $\theta$  have support radius less than  $\delta > 0$ . Let  $U' = \{(x, y) \in U \mid (x, z) \in U \text{ if } y \leq z < y + \delta\}$ . Define

$$h: U' \rightarrow \mathbb{R}^n,$$

$$h(x, y) = \int_{t \geq 0} \int_{s \in \partial E} f(x - x, y + t)\alpha(s)\beta(t) ds dt$$

Then  $h$  is  $C^\infty$  and  $\|h - f\|_{r,U'} \rightarrow 0$  as  $\delta \rightarrow 0$ . Moreover  $h(U') \subset F$  because  $f_1$  and  $\beta$  are nonnegative. If  $f(\partial U) \subset \partial F$  then  $f(x, y) \geq f(x, 0)$ , which implies  $h(x, y) \geq h(x, 0)$ . Now define  $g(x, y) = h(x, y) - h(x, 0)$ . Then  $g(U') \subset F$  and  $g(\partial U') \subset \partial F$ . If  $\delta$  is small enough, the map  $g: U' \rightarrow F$  satisfies the lemma.

**3.2. Lemma.** *Let  $E \subset \mathbb{R}^m$ ,  $F \subset \mathbb{R}^n$  be halfspaces and  $U \subset E$ ,  $V \subset F$  open sets. Then  $C^\infty(U, V)$  is dense in  $C_s^r(U, V)$ , and  $C^\infty(U, \partial U; V, \partial V)$  is dense in  $C_s^r(U, \partial U; V, \partial V)$ ,  $0 \leq r < \infty$ .*

*Proof.* This proof is almost the same as that of Theorem 2.4. The details are left to the reader.

**3.3. Theorem.** *Let  $M$  and  $N$  be  $C^r$  manifolds,  $1 \leq s \leq \infty$ ;  $\partial M$  or  $\partial N$  or both may be nonempty. Then  $C^r(M, N)$  is dense in  $C_s^r(M, N)$  and  $C^r(M, \partial M; N, \partial N)$  is dense in  $C_s^r(M, \partial M; N, \partial N)$ ,  $0 \leq r < s$ .*

*Proof.* A relative version of Theorem 3.2 is proved in the same way as Theorem 2.5. The globalization to Theorem 3.3 is just like the proof of Theorem 2.6.

QED

**3.4. Theorem.** *Every  $C^r$  manifold  $M$ ,  $1 \leq r < \infty$ , is  $C^r$  diffeomorphic to a  $C^\infty$  manifold and the latter is unique up to  $C^\infty$  diffeomorphism.*

*Proof.* Similar to the proof of Theorem 2.9, and left to the reader.

By a  $C^r$  manifold pair  $(M, M_0)$  we mean a  $C^r$  manifold  $M$  together with a  $C^r$  submanifold  $M_0$ . The approximation and globalization techniques developed so far can be combined to yield the following results; the proofs have the same general outline as the previous ones and are left to the reader.

**3.5. Theorem.** *Let  $(M, M_0)$  and  $(N, N_0)$  be  $C^r$  manifold pairs,  $1 \leq s \leq \infty$ . Suppose that  $M_0$  is closed in  $M$ , and  $M_0 \subset M - \partial M$  or  $M_0 \subset \partial M$  or  $M_0$  is a neat submanifold. Then  $C^r(M, M_0; N, N_0)$  is dense in  $C^r(M, M_0; N, N_0)$ ,  $0 \leq r < s$ . If  $1 \leq r < s$ , and  $(M, M_0)$  and  $(N, N_0)$  are  $C^r$  diffeomorphic, they are also  $C^r$  diffeomorphic.*

**3.6. Theorem.** Let  $(M, M_0)$  be a  $C^r$  manifold pair. If  $0 < r < s \leq \infty$  then  $(M, M_0)$  has a compatible  $C^s$  structure (that is,  $(M, M_0)$  is  $C^r$  diffeomorphic to a  $C^s$  manifold pair). If also  $M_0$  is closed in  $M$ , and  $M_0 \subset M - \partial M$  or  $M_0 \subset \partial M$  or  $M_0$  is neat, then the compatible  $C^s$  structure is unique up to  $C^r$  diffeomorphism of manifold pairs.

Theorem 3.6 is of use in parts of analysis (invariant manifold theory, for example) where submanifolds of low differentiability occur naturally.

There are counter-examples to the existence of  $C^\infty$  structures on  $C^0$  pairs  $(M, M_0)$ , even where  $M$  and  $M_0$  each have  $C^\infty$  structures.

We leave to the reader the adaptation of the proofs of Theorems 2.12, 2.13 and 2.14 to  $\partial$ -manifolds.

**Exercises**

- Let  $1 \leq r < s \leq \infty$ . There are  $C^r$  manifolds,  $M, N$  and closed sets  $A \subset M, B \subset N$  such that  $C^s(M, A; N, B)$  is not dense in  $C^r(M, A; N, B)$ . [Hint: let  $A = M$ . Suppose  $B \subset N$  is a  $C^r$  submanifold which is not  $C^s$ , and  $f: M \rightarrow B$  is a  $C^r$  diffeomorphism.]
- Relative versions of Theorems 3.3 through 3.6 are true.
- Theorems 3.5 and 3.6 extend to maps of manifold  $n$ -ads  $\{M_i\} \rightarrow \{N_i\}$  where  $M_n \subset \dots \subset M_0 \subset M$  and  $N_n \subset \dots \subset N_0 \subset N$  are nested families of closed neat submanifolds.
- Let  $M$  be a  $C^\infty$  manifold and  $A \subset M$  a closed neat submanifold. If  $q > 2 \dim M$  then every  $C^\infty$  embedding of  $\partial M$  in  $\mathbb{R}^q$ , or of  $A$  in  $\mathbb{R}^q$ , extends to  $C^\infty$  embedding of  $M$ .

**4. Jets and the Baire Property**

It is convenient to redefine the topologies on  $C^r(M, N)$  in a way which avoids coordinate charts.  $C^r(M, N)$  will be identified with a subset of  $C^0(M, J^r(M, N))$  where  $J^r(M, N)$  is the manifold of  $r$ -jets of maps from  $M$  to  $N$ . In this way  $C^r(M, N)$  becomes a set of continuous maps. Our first goal in this section is to define the weak and strong topologies on such sets.

We denote by  $C(X, Y)$  the set of continuous maps from a space  $X$  to a space  $Y$ . The compact open topology on  $C(X, Y)$  is generated by the subbase comprising all sets of the form

$$\{f \in C(X, Y) : f(K) \subset V\}$$

where  $K \subset X$  is compact and  $V \subset Y$  is open. We also call this the weak topology to contrast it with another topology defined below. The resulting topological space is denoted by  $C_w(X, Y)$ .

The weak topology is most useful when  $X$  is locally compact. When  $Y$  is a metric space the topology is the same as that of uniform convergence on compact sets. If  $X$  is compact and  $Y$  is metric,  $C_w(X, Y)$  has the metric

$$d(f, g) = \sup_x d(f(x), g(x)).$$

This metric is complete provided  $Y$  is a complete metric space. More generally:

**4.1. Theorem.** Let each component of  $X$  be locally compact with a countable base; let  $Y$  be a complete metric space. Then  $C_w(X, Y)$  has a complete metric.

*Proof.* It suffices to construct a complete metric on  $C_w(X, Y)$  for each component  $X_n$  of  $X$ ; therefore we assume  $X$  locally compact with a countable base. Then  $X$  has a countable covering by compact sets  $\{X_n\}$ . Each space  $C_w(X_n, Y)$  has a complete metric.

Define a map

$$\begin{aligned} \rho : C_w(X, Y) &\rightarrow \prod_n C_w(X_n, Y). \\ \rho_n(f) &= f|_{X_n}. \end{aligned}$$

Then  $\rho$  is a homeomorphism onto a closed subspace. Since the product of a countable number of complete metric spaces has a complete metric,  $C_w(X, Y)$  is homeomorphic to a closed subspace of a complete metric space and thus has a complete metric.

QED

Now let  $X$  and  $Y$  be arbitrary spaces. The space  $C_S(X, Y)$  is the set  $C(X, Y)$  with the following strong topology. Let  $\Gamma_f \subset X \times Y$  denote the graph of the map  $f$ . If  $W \subset X \times Y$  is an open set containing  $\Gamma_f$ , let

$$\mathcal{N}(f, W) = \{g \in C(X, Y) : \Gamma_g \subset W\}.$$

These sets, for all  $f$  and  $W$ , form a base for the strong topology. The induced topology on a subset of  $C(X, Y)$  is also called strong.

When  $X$  is paracompact and  $Y$  is metric,  $C_S(X, Y)$  has the base comprising all sets of the form

$$\mathcal{N}(f, \varepsilon) = \{g : d(g(x), f(x)) < \varepsilon(x), \quad \text{all } x \in X\}$$

where  $f \in C(X, Y)$  and  $\varepsilon \in C(X, \mathbb{R}_+)$  are arbitrary.

If  $X$  is compact the weak and strong topologies are the same.

We cannot expect the strong topology to have a complete metric, since it may not have any metric. But we shall see that in many cases it is a Baire space, that is, the intersection of a countable family of dense open sets is dense.

Let  $Y$  be a metric space. A subset of  $C(X, Y)$  is uniformly closed if it contains the limit of every uniformly convergent sequence in it. Observe that this concept depends on the metric on  $Y$ . A subset which is closed under pointwise convergence is uniformly closed, as is a subset which is closed in the weak topology.

**4.2. Theorem.** Let  $X$  be a paracompact space and  $Y$  a complete metric space. Then every uniformly closed subset  $Q \subset C(X, Y)$  is a Baire space in the strong topology.



**Corollary.** *If  $M$  and  $N$  are  $C^0$  manifolds, every weakly closed subset  $Q \subset C(M, N)$  is a Baire space in the strong topology.*

*Proof.* Let  $\{A_n\}_{n \in \mathbb{N}}$  be a sequence of dense open subsets of  $Q$  (referring always to the strong topology), and let  $U \subset Q$  be a nonempty open set. Then  $A_0 \cap U$  is a nonempty open subset of  $Q$ . Therefore there exists  $f_0 \in A_0 \cap U$  and  $\varepsilon_0 \in C(X, \mathbb{R}_+)$  such that

$$Q \cap \bar{\mathcal{N}}(f_0, \varepsilon_0) \subset A_0 \cap U$$

where  $\bar{\mathcal{N}}(f_0, \varepsilon_0) = \{g: d(f_0 x, g x) \leq \varepsilon_0(x)\}$ . We may obviously assume  $\varepsilon_0 < 1$ .

By recursion there are sequences  $\{f_n\}$  in  $Q$  and  $\{\varepsilon_n\}$  in  $C(X, \mathbb{R}_+)$  such that for all  $n \in \mathbb{N}$ :

$$Q \cap \bar{\mathcal{N}}(f_{n+1}, \varepsilon_{n+1}) \subset A_{n+1} \cap \bar{\mathcal{N}}(f_n, \varepsilon_n),$$

and  $\varepsilon_{n+1} \leq \varepsilon_n/2$ . The sequence  $\{f_n\}$  satisfies

$$d(f_{n+1} x, f_n x) \leq 2^{-n}$$

and so is uniformly convergent. The limit  $f$  is in  $Q$  since  $Q$  is uniformly closed. Also  $f$  belongs to every  $\bar{\mathcal{N}}(f_n, \varepsilon_n)$ , so  $f \in U$  and also  $f \in A_n$ .

QED

We now define jets of finite order  $r$ , treating first manifolds without boundary. Let  $M, N$  be  $C^r$  manifolds,  $0 \leq r < \infty$ . An  $r$ -jet from  $M$  to  $N$  is an equivalence class  $[x, f, U]_r$  of triples  $(x, f, U)$ , where  $U \subset M$  is an open set,  $x \in U$ , and  $f: U \rightarrow N$  is a  $C^r$  map; the equivalence relation is:  $[x, f, U]_r = [x', f', U']_r$  if  $x = x'$  and in some (and hence any) pair of charts adapted to  $f$  at  $x$ ,  $f$  and  $f'$  have the same derivatives up to order  $r$ . We use the notation

$$[x, f, U]_r = j_x^r f = j^r f(x)$$

to denote the  $r$ -jet of  $f$  at  $x$ . We call  $x$  the *source* and  $f(x)$  the *target* of  $[x, f, U]_r$ .

The set of all  $r$ -jets from  $M$  to  $N$  is denoted by  $J^r(M, N)$ . There are well defined *source* and *target maps*:

$$\begin{aligned} \sigma: J^r(M, N) &\rightarrow M, & \sigma[x, f, U]_r &= x, \\ \tau: J^r(M, N) &\rightarrow N, & \tau[x, f, U]_r &= f(x). \end{aligned}$$

We put

$$\sigma^{-1}(x) = J_x^r(M, N), \quad \tau^{-1}(y) = J^r(M, N)_y,$$

and

$$J_x^r(M, N) \cap J^r(M, N)_y = J_{x, y}^r(M, N);$$

this last is the set of all  $r$ -jets from  $M$  to  $N$  with source  $x$  and target  $y$ .

Consider the special case  $M = \mathbb{R}^m$ ,  $N = \mathbb{R}^n$ . We write

$$J^r(\mathbb{R}^m, \mathbb{R}^n) = J^r(m, n).$$

Suppose  $U \subset \mathbb{R}^m$  is open and  $f \in C^r(U, \mathbb{R}^n)$ . The  $r$ -jet of  $f$  at  $x \in U$  has a

canonical representative, namely the Taylor polynomial of  $f$  of order  $r$  at  $x$ . This polynomial map from  $\mathbb{R}^m$  to  $\mathbb{R}^n$  is uniquely determined by the list of derivatives of order  $r$  of  $f$  at  $x$ . This list belongs to the vector space

$$P^r(m, n) = \mathbb{R}^n \times \prod_{k=1}^r L_{\text{sym}}^k(\mathbb{R}^m, \mathbb{R}^n)$$

where  $L_{\text{sym}}^k(\mathbb{R}^m, \mathbb{R}^n)$  denotes the vector space of symmetric  $k$ -linear maps from  $\mathbb{R}^m$  to  $\mathbb{R}^n$ . Conversely any element of  $P^r(m, n)$  comes from a unique jet in  $J_x^r(m, n)$ . In this way we have identifications

$$J_x^r(m, n) = P^r(m, n)$$

and

$$J^r(m, n) = \mathbb{R}^m \times P^r(m, n).$$

In particular  $J^r(m, n)$  is a finite dimensional vector space (for  $r$  finite). If  $U \subset \mathbb{R}^m$  and  $V \subset \mathbb{R}^n$  are open sets then  $J^r(U, V)$  is an open subset of  $J^r(m, n)$ .

Now let  $M, N$  be manifolds of dimension  $m, n$  respectively. Suppose at first that  $\partial M$  and  $\partial N$  are empty. If  $(\varphi, U)$ ,  $(\psi, V)$  are charts for  $M, N$  the following map  $\theta: J^r(U, V) \rightarrow J^r(\varphi U, \psi V)$  is a bijection:

$$\theta: j_x^r f \mapsto j_y^r(\psi f \theta^{-1}), \quad y = \theta(x).$$

Thus  $\theta$  sends each jet to the jet of its local representation. Now  $J^r(\varphi U, \psi V)$  is an open set in the vector space  $J^r(m, n)$ , which is isomorphic to a Euclidean space. Therefore we can view  $(\theta, J^r(U, V))$  as a chart on  $J^r(M, N)$ ; the topology on  $J^r(M, N)$  is of course that determined by these charts. In this way  $J^r(M, N)$  is a  $C^0$  manifold. In fact if  $M, N$  are  $C^{r+s}$  manifolds,  $J^r(M, N)$  has differentiability class  $C^s$ .

For each  $C^r$  map  $f: M \rightarrow N$  we define a map

$$j^r f: M \rightarrow J^r(M, N)$$

by  $x \mapsto j^r f(x)$ . This  $r$ -prolongation of  $f$  is continuous and in fact  $C^s$  if  $M$  and  $N$  are  $C^{r+s}$ . We consider  $j^r f$  as a kind of intrinsic  $r$ th derivative of  $f$ . It is clear that  $j^r$  is injective.

**4.3. Theorem.** *The image of*

$$j^r: C^r(M, N) \rightarrow C^0(M, J^r(M, N))$$

*is closed in the weak topology.*

*Proof.* We must show that the image is closed under uniform convergence on compact sets. It suffices to consider convex compact subsets of coordinate charts. Ultimately we must prove that if  $U \subset \mathbb{R}^m$  is open and  $\{f_n\}$  is a sequence such that for each  $k = 0, \dots, r$  the sequence  $\{D^k f_n(x)\}$  converges uniformly on  $U$  to a continuous map  $g_k: U \rightarrow L^k(\mathbb{R}^m, \mathbb{R}^n)$ , then  $g_k = D^k g_0$ . This is proved by induction on  $k$ . The inductive step is the same as the case  $k = 1$ . If  $Df_n$  converges uniformly to  $g_1$  and  $f_n$  converges uniformly

to  $g_0$ , we have, for  $x, x + y \in U$ :

$$\begin{aligned} g_0(x + y) &= \lim_{n \rightarrow \infty} f_n(x + y) \\ &= \lim_{n \rightarrow \infty} f_n(x) + \lim_{n \rightarrow \infty} \int_0^1 Df_n(x + ty)y \, dt \\ &= g_0(x) + \int_0^1 g_1(x + ty)y \, dt, \end{aligned}$$

by uniform convergence. It follows easily that  $g_1 = Dg_0$ .

QED

If we give  $C^r(M, N)$  the topology induced by  $f$  from the weak or strong topology on  $C^0(M, J^r(M, N))$ , we obtain spaces which coincide with  $C_w^r(M, N)$  and  $C_S^r(M, N)$ , as the reader can verify.

From Theorems 4.1, 4.2, 4.3 we obtain:

#### 4.4. Theorem.

- (a)  $C_w^r(M, N)$  has a complete metric;
- (b) Every weakly closed subspace of  $C_S^r(M, N)$  is a Baire space (in the strong topology).

Suppose  $M$  and  $N$  are  $C^\infty$  manifolds. We define the set  $J^\infty(M, N)$  to be the inverse limit of the sequence

$$J^0(M, N) \leftarrow J^1(M, N) \leftarrow \cdots$$

and  $J_x^\infty(M, N)$  to be the inverse limit of the sequence

$$J_x^0(M, N) \leftarrow J_x^1(M, N) \leftarrow \cdots$$

An element of  $J_x^\infty(M, N)$  is, by definition, an  $\infty$ -jet at  $x$ .

The maps  $f$  fit together to define a map

$$j^\infty: C^\infty(M, N) \rightarrow C^0(M, J^\infty(M, N)).$$

Again the image is weakly closed, and the weak and strong topologies on  $C^\infty(M, N)$  are the same as those induced by  $j^\infty$  from the corresponding topologies on  $C(M, J^\infty(M, N))$ . It follows that  $C_w^\infty(M, N)$  has a complete metric and every weakly closed subspace of  $C_S^\infty(M, N)$  is Baire in the strong topology. In particular,  $C_S^\infty(M, N)$  is a Baire space.

Returning to the density of embeddings, we give an alternative proof of Theorem 2.13. It suffices to prove that if  $f_0: M \rightarrow N$  is a  $C^r$  proper map and  $\mathcal{N} \subset \text{Prop}^r(M, N)$  is a neighborhood of  $f_0$  then  $\mathcal{N}$  contains an injective immersion, for a proper injective immersion is an embedding.

We may assume that

$$\mathcal{N} = \mathcal{N}(\Phi, \Psi, K, \varepsilon),$$

the notation being as usual, where  $K = \{K_i\}_{i \in A}$  is a family of coordinate disks which covers  $M$ .

For each  $i \in A$  let

$$X_i = \{f \in \mathcal{N} : f|K_i \text{ is an embedding}\}.$$

Then  $X_i$  is dense and open in  $\mathcal{N}$ . To see this let  $B_i \subset U_i$  be a slightly larger coordinate disk containing  $K_i$  in its interior. By Theorem 1.3.5 we can approximate  $f|B_i$  by an embedding  $g_i$ ; gluing  $g_i$  and  $f$  together by a  $C^r$  map  $\lambda: M \rightarrow [0, 1]$  which is 1 on  $D_i$  and 0 on  $M - K_i$ , gives a map which embeds  $D_i$  and which tends to  $f$  as  $g_i$  tends to  $f|B_i$ . Thus  $X_i$  is dense. Openness follows from openness of embeddings.

A similar argument proves that if  $(i, j)$  is such that  $K_i \cap K_j = \emptyset$ , then the set

$$X_{ij} = \{f \in \mathcal{N} : f|K_i \cup K_j \text{ is an embedding}\}$$

is dense and open.

Let  $K^{(1)}, K^{(2)}, \dots$  be a family of refinements of  $K$  such that each  $K^{(j)}$  is a locally finite covering of  $M$  by coordinate disks, and such that for any distinct  $x, y \in M$  there exist disjoint disks  $K_i^{(j)}, K_j^{(j)} \in K^{(j)}$  with  $x \in K_i^{(j)}$ ,  $y \in K_j^{(j)}$ . Since  $M$  has a countable base, each  $K^{(n)}$  is countable.

Let  $X^{(n)}$  be the set of  $f \in \mathcal{N}$  such that  $f|K_i^{(n)} \cup K_j^{(n)}$  is an embedding whenever  $K_i^{(n)}, K_j^{(n)}$  are disjoint disks in  $K^{(n)}$ . Then each  $X^{(n)}$ , and hence  $\bigcap_n X^{(n)}$ , is the intersection of a countable family of dense open subsets of  $\mathcal{N}$ . Since the Baire property is inherited by open sets,  $\mathcal{N}$  is a Baire space. Therefore  $\bigcap_n X^{(n)}$  is dense in  $\mathcal{N}$ . This intersection is precisely the set of injective immersions in  $\mathcal{N}$ . Therefore embeddings are dense.

In our treatment of jets we have assumed that  $\partial M = \partial N = \emptyset$ . We now consider the general case where  $M$  and  $N$  are allowed to have boundaries.

The definition of  $r$ -jet is unchanged, but the topology on  $J^r(M, N)$  must be treated carefully. Consider first open subsets  $U, V$  of halfspaces  $E \subset \mathbb{R}^m$ ,  $F \subset \mathbb{R}^n$ . For each  $(x, y) \in U \times V$  there are canonical identifications (for  $r < \infty$ ):

$$\begin{aligned} J_{x,y}^r(U, V) &= \prod_{k=1}^r L_{\text{sym}}^k(\mathbb{R}^m, \mathbb{R}^n) \\ &= J_{0,0}^r(m, n). \end{aligned}$$

Consequently

$$J^r(U, V) = U \times V \times J_{0,0}^r(m, n).$$

If either  $\partial U$  or  $\partial V$  is empty, this is an open subset of a halfspace. But if  $\partial U \neq \emptyset$  and  $\partial V \neq \emptyset$  it is not. It is, however, homeomorphic to an open subset of a half space; this follows from the same property for  $U \times V$ , which in turn follows from the homeomorphism

$$[0, \infty) \times [0, \infty) \approx \mathbb{R} \times [0, \infty).$$

Thus again  $J^r(M, N)$  has a natural  $C^0$  manifold structure, and the preceding development goes through. (But if  $M$  and  $N$  are  $C^{r+s}$   $\partial$ -manifolds,  $J^r(M, N)$  has no natural  $C^s$  structure.) The treatment of jets of infinite order is the

same as before, and Theorem 3.4 holds for all manifolds. The proof of density of embeddings in  $\text{Prop}_S^0(M, N)$  can be adapted to  $\partial$ -manifolds.

### Exercises

1. Let  $X$  be locally compact and paracompact. Suppose  $Y$  has an open covering by completely metrizable subspaces. Then every weakly closed subset of  $C_S(X, Y)$  is Baire in the strong topology.

\*\*\*2. Under what conditions is the natural map

$$C_S(X, C_S(Y, Z)) \rightarrow C_S(X \times Y, Z)$$

a homeomorphism?

3. Let  $X$  be paracompact and  $Y$  metric. For each  $\varepsilon \in C(X, \mathbb{R}_+)$  define a metric  $d_\varepsilon$  on  $C(X, Y)$ :

$$d_\varepsilon(f, g) = \min \{1, \sup_x d(f(x), g(x))/\varepsilon(x)\}.$$

(a) If  $Y$  is complete each metric  $d_\varepsilon$  is complete.

(b) If  $Q \subset C(X, Y)$  is uniformly closed and  $\varepsilon$  is bounded then  $Q$  is closed in the metric space  $(C(X, Y), d_\varepsilon)$ .

(c) The strong topology on  $C(X, Y)$  is that induced by the family of metrics

$$\{d_\varepsilon : \varepsilon \in C(X, \mathbb{R}_+)\}.$$

4. The Baire property for the strong topology on uniformly closed subsets of  $C(X, Y)$  follows from Exercise 3 and the following. Let  $Q$  be a space whose topology is defined by a family  $\Delta$  of complete metrics. Suppose that  $\Delta$  is a directed set under the partial ordering:

$$d_1 \leq d_2 \quad \text{if} \quad d_1(x, y) \leq d_2(x, y) \quad \text{for all} \quad (x, y).$$

Then  $Q$  has the Baire property.

5. Let  $\{X_i\}_{i \in A}$  be a family of complete metric spaces. Let  $X$  be the product of the sets  $X_i$ , with the following *strong product topology*: a set is open if and only if its projection into each  $X_i$  is open. If  $Q \subset X$  is closed in the usual product topology, the strong product topology on  $Q$  has the Baire property.

6. If  $M$  is compact then  $C_w^r(M, \mathbb{R}^n)$  is a Banach space for  $r < \infty$ .

\*7.  $C_w^r(\mathbb{R}, \mathbb{R})$  is a complete, locally convex topological vector space, but it does not have a norm. Thus it is not a Banach space. [Hint: let  $E$  be a topological vector space. Call  $X \subset E$  *bounded* if for every neighborhood  $N \subset E$  of 0 there exists  $t > 0$  such that  $tX \subset N$ . Then  $E$  has a norm if and only if there is a bounded convex neighborhood of 0.]

8.  $C_w^r(M, \mathbb{R})$  is a separable, complete locally convex topological vector space; but it does not have a norm. (See Exercise 7.)

9. Let  $M$  be a  $C^r$  manifold,  $0 \leq r \leq \omega$ . The set  $\text{Diff}^r(M)$  of  $C^r$  diffeomorphisms of  $M$  is a topological group under composition in both the weak and the strong topologies.

10. Let  $M, N, P$  be  $C^r$  manifolds,  $0 \leq r \leq \infty$ .

(a) The composition map

$$\begin{aligned} C^r(N, P) \times C^r(M, N) &\rightarrow C^r(M, P), \\ (f, g) &\mapsto f \circ g \end{aligned}$$

is continuous in the weak topologies.

(b) For fixed  $f = f_0$  composition is continuous in  $g$  in the strong topologies.

(c) For fixed  $g = g_0$  composition is continuous in  $f$  in the strong topologies if and only if  $g$  is proper.

(d) Composition is continuous at  $(f_0, g_0)$  if and only if  $g_0$  is proper.

11. Compute the dimension of  $J^r(M, N)$ .

\*\*\*12. Is  $C_S^0(\mathbb{R}, \mathbb{R})$  paracompact? (It is not normal; see Van Douwen [1].)

13. The subspace

$$X = \{f \in C_S^0(\mathbb{R}, \mathbb{R}) : \text{Supp } f \text{ is compact}\}$$

is closed but does not have the Baire property.

14. The *limit set*  $L(f)$  of  $f: M \rightarrow N$  is the set of  $y \in N$  such that  $y = \lim x_n$  for some sequence  $\{x_n\}$  in  $M$  which has no convergent subsequence. If  $\dim N > 2 \dim M$  and  $1 \leq r \leq \infty$  then embeddings are dense in

$$\mathcal{L} = \{f \in C_S^r(M, N) : f(M) \cap L(f) = \emptyset\}.$$

[If  $f \in \mathcal{L}$ , there is an open set  $N_0 \subset N$  containing  $f(M)$  such that  $f: M \rightarrow N_0$  is proper; use Theorem 2.13.]

15. An open set  $P \subset J^r(m, n)$  is *natural* if it is closed under composition with jets of local diffeomorphisms of  $\mathbb{R}^m$  and  $\mathbb{R}^n$ . Given such a  $P$  and  $C^r$  manifolds  $M, N$  define  $P(M, N)$  to be the set of  $C^r$  maps from  $M$  to  $N$  all of whose local representations have their  $r$ -jets in  $P$ . Then  $P(M, N)$  is open in  $C_S^r(M, N)$ .

16. The set of immersions is a Baire subset of  $C_w^r(M, N)$ ,  $1 \leq r \leq \infty$  if  $\dim M \leq 2 \dim N$ . (A Baire subset is the intersection of a countable family of dense open subsets.)

\*17. The space  $C_S^r(M, N)$  is completely regular,  $0 \leq r \leq \infty$ .

## 5. Analytic Approximations

Partitions of unity are of no use for constructing analytic approximations because an analytic function on  $\mathbb{R}^n$  is constant if it has bounded support. More subtle globalization techniques are needed.

Using methods from complex analysis, Grauert and Remmert [1] have proved the following deep result:

**5.1. Theorem.** *Let  $M$  and  $N$  be  $C^\omega$  manifolds. Then  $C^\omega(M, N)$  is dense in  $C_S^r(M, N)$ ,  $0 \leq r \leq \infty$ .*

That this is true is very fortunate, for it means that  $C^\omega$  differential topology is no different from the  $C^\omega$  theory for such questions as diffeomorphism classification of manifolds, existence of embeddings and immersions, etc. These questions concern *open* sets of maps, from one manifold to another. Where *closed* sets of maps or individual maps are considered, for example solutions to differential equations, the degree of differentiability may play an important role. It is also an important consideration whenever maps from a manifold to itself are studied. For such maps problems of conjugacy and iteration arise, and high differentiability is sometimes a crucial hypothesis.

Occasionally analytic maps are a useful tool because their level surfaces—even critical ones—are analytic varieties. More general than manifolds, analytic varieties still are topologically fairly simple. In particular, they can be triangulated.

Morrey [1] proved Theorem 5.1 for compact manifolds. An elegant treatment of this case was given by Bochner [1] under the assumption of an analytic Riemannian metric.

Once Theorem 5.1 is known, the existence of compatible  $C^\omega$  structures on  $C^r$  manifolds can be proved using the maximality argument of Theorem 2.9. This was first proved by Whitney [2] using the following easier approximation result:

**5.2. Theorem** (Whitney [6]). *Let  $U \subset \mathbb{R}^m$  be open and  $f: U \rightarrow \mathbb{R}$  a  $C^r$  map,  $0 \leq r < \infty$ . Let  $v: \mathbb{R}^m \rightarrow [0, 1]$  be a  $C^\infty$  map of bounded support, equal to 1 on a neighborhood of a compact set  $K \subset U$ . Set  $h(x) = v(x)f(x)$ . Let  $\delta: \mathbb{R}^m \rightarrow \mathbb{R}$ ,  $\delta(x) = \exp(-|x|^2)$ . Let  $T = 1/\int_{\mathbb{R}^m} \delta$ . Let  $\varepsilon > 0$ . Then for  $\kappa > 0$  sufficiently large, the convolution  $g$  of  $h$  with the function  $T\kappa^m \delta(\kappa, x)$  is analytic and satisfies  $\|g - f\|_r, \kappa < \varepsilon$ .*

The proof is straightforward, but in the absence of partitions of unity it is not easy to pass from Theorem 5.2 to an approximation theorem for abstract  $C^\omega$  manifolds. For  $C^\omega$  submanifolds of  $\mathbb{R}^n$ , however, Theorem 5.2 works quite nicely once the technique of tubular neighborhoods is available.

We shall use Theorem 5.2 to prove, in Section 4.6, that  $C^\infty$  manifolds have compatible  $C^\omega$  structures.

Nash [1] proved that a compact connected  $C^\infty$  manifold without boundary is  $C^\infty$  diffeomorphic to a component of a real algebraic variety; he also proved an algebraic approximation theorem for maps of such manifolds; see Shiata [1].

An interesting topological application of Nash's results was made by Artin and Mazur [1]: if  $M$  is a compact connected  $C^\infty$  manifold there is a dense subset of  $C_r^0(M, M)$  of maps  $f: M \rightarrow M$  such that the number of fixed points of  $f^n$  is bounded above by a function of the form  $Ae^{\lambda n}$  where  $A$  and  $\lambda$  are positive constants.

### Exercise

1. If  $U \subset \mathbb{R}^m$  is open, polynomials are dense in  $C_r^\infty(U, \mathbb{R})$ . [Hint: replace the exponential in Theorem 5.2 by a Taylor polynomial.]

## Chapter 3

### Transversality

Transversality unlocks the secrets of the manifold.

—H. E. Winkelkemper

“Transversal” is a noun; the adjective is “transverse.”

—J. H. C. Whitehead. 1959

Consider the following statements:

1. If  $f: S^2 \rightarrow \mathbb{R}^2$  is  $C^1$ , then  $f^{-1}(y)$  is finite for “most” points  $y \in \mathbb{R}^2$ .
2. Two lines in  $\mathbb{R}^3$  do not intersect “in general.”
3. If  $f: \mathbb{R} \rightarrow \mathbb{R}$  is  $C^1$ , “almost all” horizontal lines in  $\mathbb{R} \times \mathbb{R}$  are nowhere tangent to the graph of  $f$ .
4. “Generically” a  $C^1$  immersion  $S^1 \rightarrow \mathbb{R}^2$  has only a finite number of crossing points.

These statements illustrate a type of reasoning that is common in differential topology. Most people would agree they are plausible. Yet there is an element of uncertainty about them, due to the vagueness of the words in quotation marks. Even if these are given precise definitions, it is obvious that something needs to be proved. The purpose of this chapter is to develop the mathematics needed to justify such statements.

The basis of this mathematics is a profound result in analysis, due to A. P. Morse and A. Sard.<sup>1</sup> It says that if  $f: \mathbb{R}^m \rightarrow \mathbb{R}^k$  is  $C^r$ , where  $r > \max\{0, m - k\}$ , then the set of critical values has measure zero in  $\mathbb{R}^k$ . We prove this only for the case  $r = \infty$ . This version is considerably easier and is adequate for differential topology.

The reader may prefer to accept the Morse–Sard theorem (Theorem 1.3) on faith, since the method of proof is not used elsewhere.

In Section 3.2 the Morse–Sard theorem is used to prove various transversality theorems. These guarantee the existence of plenty of maps  $f: M \rightarrow N$  which are transverse to a submanifold  $A \subset N$ . This is a fundamental result in differential topology; analogous statements in the theory of topological or polyhedral manifolds are false.

In this chapter and the remainder of the book, *all manifolds and submanifolds are assumed to be  $C^\infty$*  unless the contrary is stated. In view of the approximation results of the preceding chapter this is not a serious restriction.

<sup>1</sup> The first theorem of this kind was proved by A. B. Brown [1]. See also Dubovickii [1].

### 1. The Morse-Sard Theorem

An  $n$ -cube  $C \subset \mathbb{R}^n$  of edge  $\lambda > 0$  is a product

$$C = I_1 \times \cdots \times I_n \subset \mathbb{R} \times \cdots \times \mathbb{R} = \mathbb{R}^n$$

of closed intervals of length  $\lambda$ ; thus

$$I_j = [a_j, a_j + \lambda] \subset \mathbb{R}.$$

The measure (or  $n$ -measure) of  $C$  is

$$\mu(C) = \mu_n(C) = \lambda^n.$$

A subset  $X \subset \mathbb{R}^n$  has *measure zero* if for every  $\varepsilon > 0$  it can be covered by a family of  $n$ -cubes, the sum of whose measures is less than  $\varepsilon$ . A countable union of sets of measure zero has measure zero. Therefore  $X$  has measure zero if every point of  $X$  has a neighborhood in  $X$  of measure zero (by Lindelöf's principle).

**1.1. Lemma.** Let  $U \subset \mathbb{R}^n$  be an open set and  $f: U \rightarrow \mathbb{R}^n$  a  $C^1$  map. If  $X \subset U$  has measure zero, so has  $f(X)$ .

*Proof.* Every point of  $X$  belongs to an open ball  $B \subset U$  such that  $\|Df(x)\|$  is uniformly bounded on  $B$ , say by  $\kappa > 0$ . Then

$$|f(x) - f(y)| \leq \kappa|x - y|$$

for all  $x, y \in B$ . It follows that if  $C \subset B$  is an  $n$ -cube of edge  $\lambda$ , then  $f(C)$  is contained in an  $n$ -cube  $C'$  of edge less than  $\sqrt{n}\kappa\lambda = L\lambda$ . Therefore  $\mu(C') < L^n\mu(C)$ .

Write  $X = \bigcup_1^\infty X_j$  where each  $X_j$  is a compact subset of a ball  $B$  as above. For each  $\varepsilon > 0$ ,  $X_j \subset \bigcup_k C_k$  where each  $C_k$  is an  $n$ -cube and  $\sum \mu(C_k) < \varepsilon$ . It follows that  $f(X_j) \subset \bigcup_k C'_k$  where the sum of the measures of the  $n$ -cubes  $C'_k$  is less than  $L^n\varepsilon$ . Hence each  $f(X_j)$  has measure zero, and so  $f(X)$  has measure zero.

QED

Now let  $M$  be a ( $C^\infty$ )  $n$ -dimensional manifold. A subset  $X \subset M$  is said to have *measure zero* if for every chart  $(\varphi, U)$ , the set  $\varphi(U \cap X) \subset \mathbb{R}^n$  has measure zero. Because of Lemma 1.1, this will be true provided there is *some* atlas of charts with this property.

Notice that we have not defined the "measure" of a subset of  $M$ , but only a certain kind of subset which we say "has measure zero." This is in accordance with the red herring principle (Chapter 1, page 22, footnote).

It can be shown that a cube does not have measure zero. Therefore a set of measure zero in  $\mathbb{R}^n$  cannot contain a cube; hence it has empty interior. It follows that a *closed* measure zero subset of  $\mathbb{R}^n$ , or of a manifold  $M$ , is nowhere dense. More generally, suppose  $X \subset M$  has measure zero and is

$\sigma$ -compact, that is,  $X$  is the union of a countable collection of compact sets. Each of these is nowhere dense, and so  $M - X$  is dense by the Baire category theorem. The complement of  $X$  is *residual*, that is, it contains the intersection of a countable family of dense open sets. The Baire theorem says a residual subset of a complete metric space is dense. Note that the intersection of countably many residual sets is residual.

**1.2. Proposition.** Let  $M, N$  be manifolds with  $\dim M < \dim N$ . If  $f: M \rightarrow N$  is a  $C^1$  map then  $N - f(M)$  is dense.

*Proof.* It suffices to show that  $f(M)$  has measure zero. This follows from:  $g(U) \subset \mathbb{R}^n$  has measure zero if  $U \subset \mathbb{R}^m$  is open and  $g: U \rightarrow \mathbb{R}^n$  is  $C^1$ , with  $m < n$ . To prove this assertion, write  $g$  as a composition of  $C^1$  maps

$$U \xrightarrow{h} U \times 0 \subset U \times \mathbb{R}^{n-m} \xrightarrow{g} \mathbb{R}^n.$$

Clearly  $U \times 0$  has  $n$ -measure zero in

$$U \times \mathbb{R}^{n-m} \subset \mathbb{R}^m \times \mathbb{R}^{n-m} = \mathbb{R}^n;$$

hence the proposition follows from Lemma 1.1 applied to  $hg$ .

QED

Recall that a point  $x \in M$  is *critical* for a  $C^1$  map  $f: M \rightarrow N$  if the linear map  $T_x f: M_x \rightarrow N_{f(x)}$  is not surjective. We denote by  $\sum_f$  the set of critical points of  $f$ . Note that  $N - f(\sum_f)$  is the set of regular values of  $f$ .

**1.3. Morse-Sard Theorem.** Let  $M, N$  be manifolds of dimensions  $m, n$  and  $f: M \rightarrow N$  a  $C^r$  map. If

$$r > \max \{0, m - n\}$$

then  $f(\sum_f)$  has measure zero in  $N$ . The set of regular values of  $f$  is residual and therefore dense.

The differentiability requirement is strange but necessary. We shall prove the theorem only in the  $C^\infty$  case. Before beginning the proof let us examine the implications of the theorem in particular instances.

Let  $f: \mathbb{R} \rightarrow \mathbb{R}$  be  $C^1$ . If  $y$  is a regular value, then the horizontal line  $\mathbb{R} \times y \subset \mathbb{R} \times \mathbb{R}$  is transverse to the graph of  $f$  (Figure 3-1). Thus the theorem implies that "most" horizontal lines are transverse to the graph.

Consider next a map  $f: \mathbb{R}^2 \rightarrow \mathbb{R}^1$ . In this case the theorem says that most horizontal planes  $\mathbb{R}^2 \times z \subset \mathbb{R}^2 \times \mathbb{R}$  are transverse to the graph of  $f$  if  $f$  is  $C^2$  (Figure 3-2). This seems plausible. In fact it seems plausible that this should hold even if  $f$  is merely  $C^1$ ; but Whitney [1] has found a counter-example! In fact Whitney constructs a  $C^1$  map  $f: \mathbb{R}^2 \rightarrow \mathbb{R}^1$  whose critical set contains a topological arc  $I$ , yet  $f|I$  is not constant, so that  $f(\sum_f)$  contains an open subset of  $\mathbb{R}$ . This leads to the following paradox: The graph of  $f$  is a surface  $S \subset \mathbb{R}^3$  on which there is an arc  $A$ , at every point of which the surface has a horizontal tangent plane, yet  $A$  is not at a constant height. To

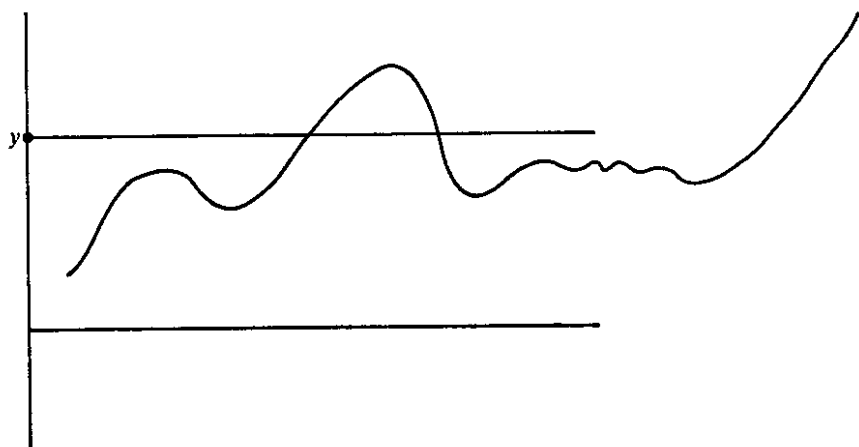

Figure 3-1.

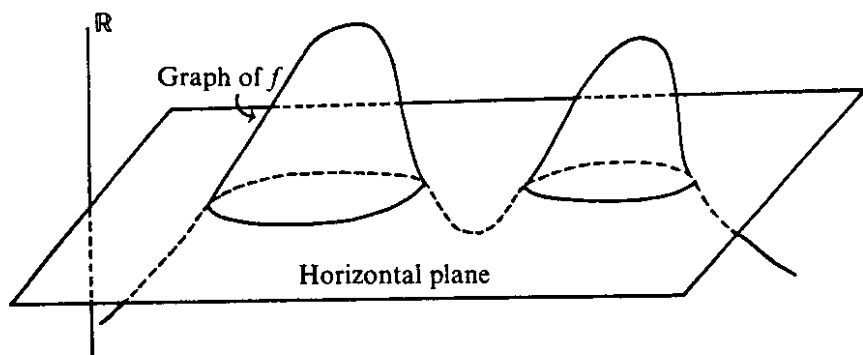

Figure 3-2.

make this more vivid, imagine that  $S$  is a hill and  $A$  a path on the hill. The hill is level at every point of the path, yet the path goes up and down.

*Proof of the Morse-Sard Theorem for  $C^\infty$  Maps.* It suffices to prove a local theorem; thus we deal with a  $C^\infty$  map  $f: W \rightarrow \mathbb{R}^n$  where  $W \subset \mathbb{R}^m$  is open. If  $m < n$  then  $f(W)$  has measure zero. We assume from now on that  $m \geq n$ .

A differential operator of order 1 means a map  $C^\infty(W, \mathbb{R}) \rightarrow C^\infty(W, \mathbb{R})$  of the form

$$g \mapsto \frac{\partial g}{\partial x_k}$$

for some  $k \in \{1, \dots, m\}$ . The composition of  $v$  such operators is a differential operator of order  $v$ .

We express the critical set  $\Sigma_f$  as the union of three subsets as follows. Write  $f(x) = (f_1(x), \dots, f_n(x))$ .

### 1. The Morse-Sard Theorem

$\Sigma^1$  is the set of points  $p \in \Sigma_f$  such that  $\Delta f_i(p) = 0$  for all differential operators  $\Delta$  of order  $\leq m/n$  and all  $i = 1, \dots, n$ .

$\Sigma^2$  is the set of points  $p \in \Sigma_f$  such that  $\Delta f_i(p) \neq 0$  for some  $i$  and some differential operator  $\Delta$  of order  $\geq 2$ ;

$\Sigma^3$  is the set of points  $p \in \Sigma_f$  such that  $\frac{\partial f_i}{\partial x_j}(p) \neq 0$  for some  $i, j$ .

Clearly  $\Sigma_f = \Sigma^1 \cup \Sigma^2 \cup \Sigma^3$ .

We now show that  $f(\Sigma^1)$  has measure zero. Let  $v$  be the smallest integer such that  $v > m/n$ . The Taylor expansion of  $f$  of order  $v$  about points of  $\Sigma^1$  shows that every point of  $\Sigma^1$  has a neighborhood  $U$  in  $W$  such that if  $p \in \Sigma^1 \cap U$  and  $q \in U$  then

$$|f(p) - f(q)| \leq B|p - q|^v, \quad B \geq 0.$$

We take  $U$  to be a cube. It suffices to prove that  $f(U \cap \Sigma^1)$  has measure zero.

Let  $\lambda$  be the edge of  $U$  and  $s$  a large integer. Divide  $U$  into  $s^m$  cubes of edge  $\lambda/s$ . Of these, denote those that meet  $\Sigma^1$  by  $C_k, k = 1, \dots, t$ , where  $t \leq s^m$ .

Each  $C_k$  is contained in a ball of radius  $(\lambda/s)\sqrt{m}$  centered at a point of  $U \cap X$ . Therefore  $f(C_k)$  is contained in a cube  $C'_k \subset \mathbb{R}^n$  whose edge is not more than

$$2B \left( \frac{\lambda}{s} \sqrt{m} \right)^v = A \left( \frac{\lambda}{s} \right)^v.$$

Hence the sum  $\sigma(s)$  of the  $n$ -measures of these cubes  $C'_k$  is not more than

$$s^m A^n \left( \frac{\lambda}{s} \right)^{vn} = s^{m-vn} A^n \lambda^{vn}.$$

Since  $m - vn < 0$  it follows that  $\sigma(s) \rightarrow 0$  as  $s \rightarrow \infty$ . Thus  $f(U \cap \Sigma^1)$  has measure zero.

Note that  $\Sigma^1 = \Sigma_f$  if  $n = m = 1$ . Therefore the Morse-Sard theorem is proved for this case. We proceed by induction on  $m$ . Thus we take  $m > 1$  and we assume the truth of the theorem for any  $C^\infty$  map  $P \rightarrow Q$  where  $\dim P < m$ .

We prove next that  $f(\Sigma^2 - \Sigma^3)$  has measure zero. For each  $p \in \Sigma^2 - \Sigma^3$  there is a differential operator  $\theta$  such that

$$(1) \quad \begin{cases} \theta f_i(p) = 0, \\ \frac{\partial}{\partial x_j} \theta f_i(p) \neq 0 \end{cases}$$

for some  $i, j$ . Let  $X$  be the set of such points, for fixed  $\theta, i, j$ . It suffices to prove that  $f(X)$  has measure zero.

Formula (1) shows that  $0 \in \mathbb{R}$  is a regular value for the map  $\theta f_i: W \rightarrow \mathbb{R}$ . Because  $f_i$  is  $C^\infty$ , so is  $\theta f_i$ . Therefore  $X$  is a  $C^\infty$  submanifold of dimension  $m - 1$ . Clearly  $\Sigma_f \cap X \subset \Sigma_{f_i|_X}$ . By the induction hypothesis,  $f(\Sigma_{f_i|_X})$  has measure zero. Hence  $f(\Sigma^2 - \Sigma^3)$  has measure zero.

It remains to prove that  $f(\Sigma^3)$  has measure zero. Every point  $p \in \Sigma^3$  has an open neighborhood  $U \subset W$  on which, for some  $i, j$ ,  $\partial f_i / \partial x_j \neq 0$ . By the implicit function theorem we may choose  $U$  so that there is an open set  $A \times B \subset \mathbb{R}^{m-1} \times \mathbb{R}$  and a  $C^\infty$  diffeomorphism  $h: A \times B \rightarrow U$  such that the following diagram commutes:

$$\begin{array}{ccc} A \times B & \xrightarrow{h} & U \\ \downarrow & & \downarrow f \\ B & \subset & \mathbb{R} \end{array}$$

In other words  $f_i(x_1, \dots, x_{m-1}, t) \equiv t$  for  $(x, t) \in A \times B$ .

For notational convenience we reorder the coordinates in  $\mathbb{R}^n$  so that  $f_i = f_n$ . We identify  $U$  with  $A \times B$  via  $h$ ; now  $f|U$  has the form

$$\begin{aligned} \mathbb{R}^{m-1} \times \mathbb{R} \supset A \times B &\xrightarrow{f} \mathbb{R}^{n-1} \times \mathbb{R}, \\ f(x, t) &= (u_t(x), t) \end{aligned}$$

where for each  $t \in B$ ,  $u_t: A \rightarrow \mathbb{R}^{n-1}$  is a  $C^\infty$  map. It is easy to see that  $(x, t)$  is critical for  $f$  if and only if  $x$  is critical for  $u_t$ . Thus

$$\sum_f \cap (A \times B) = \bigcup_{t \in B} \sum_{u_t} \times t.$$

Since  $\dim A = n - 1$ , the inductive hypothesis implies that

$$\mu_{n-1}(u_t(\sum_{u_t})) = 0$$

where  $\mu_{n-1}$  denotes Lebesgue measure in  $\mathbb{R}^{n-1}$ . Fubini's theorem now implies that

$$\begin{aligned} \mu_n \left( \bigcup_{t \in B} f(\sum_{u_t} \times t) \right) &= \int_B \mu_{n-1}(u_t(\sum_{u_t})) dt \\ &= \int_B 0 dt = 0. \end{aligned}$$

Therefore, reverting to the original notation, we see that  $f(\Sigma^3 \cap U)$  has measure 0.

QED

As the first application of the Morse-Sard Theorem we prove the following topological result, equivalent to Brouwer's fixed-point theorem:

**1.4. Theorem.** *There is no retraction  $D^n \rightarrow S^{n-1}$ .*

*Proof.* Suppose  $f: D^n \rightarrow S^{n-1}$  is a retraction, i.e., a continuous map such that  $f|S^{n-1} = \text{identity}$ . We can find a new retraction  $g: D^n \rightarrow S^{n-1}$  which is  $C^\infty$  on a neighborhood of  $S^{n-1}$  in  $D^n$ , for example

$$g(x) = \begin{cases} f(x/|x|) & \text{if } 1/2 \leq |x| \leq 1 \\ f(2x) & \text{if } 0 \leq |x| \leq 1/2. \end{cases}$$

Approximate  $g$  by a  $C^\infty$  map  $h: D^n \rightarrow S^{n-1}$  which agrees with  $g$  on a neighborhood of  $S^{n-1}$ ; then  $h$  is a  $C^\infty$  retraction.

### 1. The Morse-Sard Theorem

By Theorem 1.3 there is a regular value  $y \in S^{n-1}$  of  $h$ . (All we need is *one* regular value!) Then  $h^{-1}(y)$  is a compact one-dimensional submanifold  $V \subset D^n$ , and

$$\partial V = V \cap S^{n-1}.$$

Therefore  $y$  is a boundary point of  $V$ . The component of  $V$  which contains  $y$  is diffeomorphic to a closed interval; it *must have another boundary point*  $z \in S^{n-1}$ ,  $z \neq y$ . But  $h(z) = z$ , contradicting  $z \in h^{-1}(y)$ .

QED

The same argument proves that if  $M$  is any compact smooth manifold, there is no retraction  $M \rightarrow \partial M$ . This is true even without smoothness, but the proof requires algebraic topology.

Brouwer's fixed-point theorem says that any continuous map  $f: D^n \rightarrow D^n$  has a fixed point, that is,  $f(x) = x$  for some  $x$ . This follows from 1.4; for if  $f(x) \neq x$  for all  $x$ , a retraction  $g: D^n \rightarrow S^{n-1}$  is obtained by sending  $x$  to the intersection of  $S^{n-1}$  with the ray through  $x$  emanating from  $f(x)$ ; see Figure 3-3.

This proof that  $D^n$  does not retract to  $S^{n-1}$  illustrates the interplay between maps and manifolds. The final step of the proof is the observation that a compact 1-dimensional manifold has an even number of boundary components. Thus the very simple topology of 1-manifolds leads to a highly nontrivial result about maps.

This method of studying maps is used frequently in differential topology. Its basic pattern is: approximate by a  $C^\infty$  map, find a regular value, and then exploit the topology of the inverse image of the regular value.

An important extension of the method uses not a regular value but a submanifold to which the map is transverse. To achieve transversality, further approximation theorems are needed. These are developed in the next section.

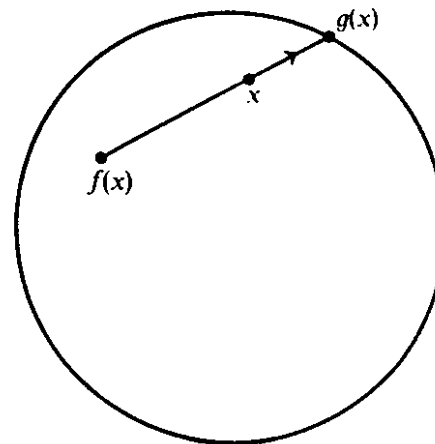

Figure 3-3.

## Exercises

- \*1. Let  $f: \mathbb{R} \rightarrow \mathbb{R}$  be differentiable (not necessarily  $C^1$ ). Then the set of critical values has measure 0.
2. (a) For every  $y_0 \in N$ , the set  

$$\{f \in C^r(M, N): y_0 \text{ is a regular value}\}$$
is open and dense in  $C^r_s(M, N)$ ,  $1 \leq r \leq \infty$ .  
(b) Given  $y_0 \in N$ ,  $f_0: M \rightarrow N$ , a neighborhood  $\mathcal{N} \subset C^r_s(M, N)$  of  $f_0$ , and a neighborhood  $W \subset M$  of  $f_0^{-1}(y_0)$ , there exists  $g \in \mathcal{N}$  such that  $y_0$  is a regular value and  $g = f_0$  on  $M - W$ .
3. Let  $M$  be a manifold without boundary and  $K \subset M$  a closed set. Every neighborhood  $U \subset M$  of  $K$  contains a closed neighborhood of  $K$  which is a smooth submanifold of  $M$ . [Consider  $\lambda^{-1}[0, y]$  where  $\lambda: M \rightarrow [0, 1]$  is 1 on  $K$ , has support in  $U$ , and  $y$  is a regular value of  $\lambda$ .]
4. (a) Let  $M$  be a connected manifold and  $f: M \rightarrow N$  an analytic map. Let  $\Sigma \subset M$  be the set of critical points. If  $\Sigma \neq M$  then  $f^{-1}f(\Sigma)$  has measure zero.  
(b) If  $f$  is merely  $C^\infty$ , the conclusion of (a) can be false.
- \*\*\*5. Let  $U \subset \mathbb{R}^3$  and  $V \subset \mathbb{R}^2$  be open sets. If  $f: U \rightarrow V$  is  $C^1$  and surjective, does  $f$  necessarily have rank 2 at some point of  $U$ ?

## 2. Transversality

Let  $f: M \rightarrow N$  be a  $C^1$  map and  $A \subset N$  a submanifold. If  $K \subset M$  we write  $f \pitchfork_K A$  to mean that  $f$  is *transverse to  $A$  along  $K$* , that is, whenever  $x \in K$  and  $f(x) = y \in A$ , the tangent space  $N_x$  is spanned by  $A_y$  and the image  $T_x f(M_x)$ . When  $K = M$  we simply write  $f \pitchfork A$ .

In Sections 1.3 and 1.4 it was shown that if  $f \pitchfork A$  then  $f^{-1}(A)$  is a submanifold (under certain restrictions on boundary behavior). This is one of the main reasons for the importance of transversality.

Define

$$\pitchfork_K^r(M, N; A) = \{f \in C^r(M, N): f \pitchfork_K A\},$$

and

$$\pitchfork^r(M, N; A) = \pitchfork_M^r(M, N; A).$$

The main result of this section is the following theorem. Recall that a *residual* subset of a space  $X$  is one which contains the intersection of countably many dense open sets. (Remember that all manifolds and submanifolds are tacitly assumed to be  $C^\infty$ .)

**2.1. Transversality Theorem.** *Let  $M, N$  be manifolds and  $A \subset N$  a submanifold. Let  $1 \leq r \leq \infty$ . Then:*

- (a)  $\pitchfork^r(M, N; A)$  is *residual (and therefore dense)* in  $C^r(M, N)$  for both the strong and weak topologies.  
(b) Suppose  $A$  is closed in  $N$ . If  $L \subset M$  is closed [resp. compact], then  $\pitchfork_L^r(M, N; A)$  is *dense and open* in  $C^r_s(M, N)$  [resp. in  $C^r_w(M, N)$ ].

The proof is based on the Morse–Sard theorem for the local result, and on the same globalization that was used for openness and density of immer-

sions in Chapter 2. Since this technique will be used more than once, we first develop it abstractly.

Let  $M$  and  $N$  be  $C^r$  manifolds,  $0 \leq r \leq \infty$ . By a  *$C^r$  mapping class* on  $(M, N)$  we mean a function  $\mathcal{X}$  of the following type. The domain of  $\mathcal{X}$  is the set of triples  $(L, U, V)$  where  $U \subset M$ ,  $V \subset N$  are open,  $L \subset M$  is closed, and  $L \subset U$ . To each triple  $\mathcal{X}$  assigns a set of maps  $\mathcal{X}_L(U, V) \subset C^r(U, V)$ . In addition  $\mathcal{X}$  must satisfy the following *localization axiom*:

Given triples  $(L, U, V)$  a map  $f \in C^r(U, V)$  is in  $\mathcal{X}_L(U, V)$  provided there exist triples  $(L_i, U_i, V_i)$  and maps  $f_i \in \mathcal{X}_{L_i}(U_i, V_i)$  such that  $L \subset \cup L_i$  and  $f = f_i$  in a neighborhood of  $L_i$ , for all  $i$ .

An example to keep in mind is:

$$\mathcal{X}_L(U, V) = \bigcap_L^r(U, V; V \cap A).$$

A mapping class  $\mathcal{X}$  is called *rich* if there are open covers  $\mathcal{U}, \mathcal{V}$  of  $M, N$  such that whenever open sets  $U \subset M$ ,  $V \subset N$  are subsets of elements of  $\mathcal{U}, \mathcal{V}$  and  $L \subset U$  is compact, then  $\mathcal{X}_L(U, V)$  is dense and open in  $C^r_w(U, V)$ .

**2.2. Globalization Theorem.** *Let  $\mathcal{X}$  be a rich  $C^r$  mapping functor on  $(M, N)$ ,  $0 \leq r \leq \infty$ . For every closed set  $L \subset M$ :*

- (a)  $\mathcal{X}_L(M, N)$  is *dense and open* in  $C^r_s(M, N)$ ;  
(b)  $\mathcal{X}_L(M, N)$  is *dense and open* in  $C^r_w(M, N)$  if  $L$  is compact.

*Proof.* Fix  $L$  and  $f \in C^r(M, N)$ . In what follows  $i$  runs over a countable indexing set  $A$ . Let  $\Phi = \{\varphi_i, U_i\}$  be a locally finite atlas on  $M$ ,  $K_i \subset U_i$  compact sets such that  $L = \cup K_i$ , and  $\Psi = \{\psi_i, V_i\}$  a family of charts on  $N$  such that  $f(K_i) \subset V_i$ . Because  $\mathcal{X}$  is rich we can choose  $U_i$  and  $V_i$  so that  $\mathcal{X}_{K_i}(U_i, V_i)$  is dense and open in  $C^r_w(U_i, V_i)$  for every open set  $E \subset U_i$  which contains  $K_i$ .

Define  $\mathcal{M} \subset C^r(M, N)$  to be the set of all  $g \in C^r(M, N)$  such that

$$g|_{U_i} \in \mathcal{X}_{K_i}(U_i, V_i) \quad \text{for all } i \in A.$$

The localization axiom implies  $\mathcal{M} \subset \mathcal{X}_L(M, N)$ .

Suppose  $f \in \mathcal{X}_L(M, N)$ . Then  $f \in \mathcal{M}$  by the localization axiom. Our assumption that each  $\mathcal{X}_{K_i}(U_i, V_i)$  is weakly open implies that when  $L$  is compact  $\mathcal{M}$  is weakly open (since  $A$  is then finite), while in general  $\mathcal{M}$  is strongly open (because  $\Phi$  is locally finite). This proves the two openness statements in Theorem 2.2.

We now drop the assumption that  $f \in \mathcal{X}_L(M, N)$  and proceed to the density part of Theorem 2.2.

For each  $i$  let  $\varepsilon_i > 0$  be given. Then there is defined the strong basic neighborhood

$$\mathcal{N} = \mathcal{N}^r(f; \Phi, \Psi, K, \varepsilon)$$

where  $K = \{K_i\}_{i \in A}$  and  $\varepsilon = \{\varepsilon_i\}_{i \in A}$ .

Fix  $j \in A$ . Let  $E = U_j \cap f^{-1}(V_j)$ ; then  $K_j \subset E$ . Since  $\mathcal{X}$  is rich,  $\mathcal{X}_{K_j}(E, V_j)$  is dense. Let  $\lambda: E \rightarrow [0, 1]$  be a  $C^r$  map with compact support, such that  $\lambda = 1$  near  $K_j$ .



To simplify notation, identify  $V_j$  with an open subset of a halfspace via  $\psi_j$ , so that vector operations make sense on elements of  $V_j$ .

If  $g \in C_w^r(E, V_j)$  is sufficiently close to  $f|E$ , the following map  $\Gamma(g) = h \in C^r(M, N)$  is well-defined:

$$h(x) = \begin{cases} f(x) + \lambda(x)[g(x) - f(x)] & \text{if } x \in E \\ f(x) & \text{if } x \in M - E. \end{cases}$$

Moreover, as  $g$  tends to  $f|E$  in the weak topology,  $h \rightarrow f$  in the strong topology. Since  $\mathcal{X}_{K_j}(E, V_j)$  is dense, we can choose  $g \in \mathcal{X}_{K_j}(E, V_j)$  so close to  $f|E$  that  $h \in \mathcal{N}$ . Since  $h = g$  near  $K_j$  it follows that  $h \in \mathcal{X}_{K_j}(M, N)$ .

This shows that for all  $i \in A$ , the set  $\mathcal{X}_{K_i}(M, N)$  is dense in  $C_w^r(M, N)$ ; and we already know it is open. It follows from Baire that  $\bigcap_i \mathcal{X}_{K_i}(M, N)$  is strongly dense; since this set contains  $\mathcal{X}_L(M, N)$ , the latter is therefore strongly dense.

The proof that  $\mathcal{X}_L(M, N)$  is weakly dense when  $L$  is compact, is similar.

QED

The proof of Theorem 2.1 will be based on the following semilocal result.

**2.3. Lemma.** *Let  $K$  be a compact set in a manifold  $U$ ,  $\mathbb{R}^a \subset \mathbb{R}^n$  a linear subspace, and  $V \subset \mathbb{R}^n$  an open set. Then*

$$\bigcap_K^r(U, V; \mathbb{R}^a \cap V)$$

*is dense and open in  $C_w^r(U, V)$ ,  $1 \leq r \leq \infty$ .*

*Proof.* Since  $C_w^r(U, V)$  is open in  $C_w^r(U, \mathbb{R}^n)$  it suffices to take  $V = \mathbb{R}^n$ .

Let  $\pi: \mathbb{R}^n \rightarrow \mathbb{R}^n/\mathbb{R}^a$  be the projection. If  $f \in C^r(U, \mathbb{R}^n)$  and  $x \in U$ , then  $f \in \bigcap_x \mathbb{R}^a$  if and only if: either (i)  $f(x) \notin \mathbb{R}^a$ , or (ii)  $x \in \mathbb{R}^a$  and  $x$  is a regular point for  $\pi f: U \rightarrow \mathbb{R}^n/\mathbb{R}^a$ .

Suppose  $f \in \bigcap_K \mathbb{R}^a$ . Then each  $y \in K$  has a compact neighborhood  $K_y \subset K$  such that either (i) holds for all  $x \in K_y$ , or (ii) holds for all  $x \in K_y$ . Let such a  $K_y$  be chosen. It is easily seen that whether (i) or (ii) holds  $y$ , the set of  $f \in C_w^r(U, \mathbb{R}^n)$  such that  $f \in \bigcap_{K_y} \mathbb{R}^a$  is open. Since  $K$  is covered by a finite set of neighborhoods  $K_{y_1}, \dots, K_{y_s}$ , it follows that  $\bigcap_K^r(U, \mathbb{R}^n; \mathbb{R}^a)$  is open.

We now prove denseness. Since  $C^\infty$  maps are dense in  $C_w^r(U, \mathbb{R}^n)$ , it suffices to show that an arbitrary  $C^\infty$  map  $g: U \rightarrow \mathbb{R}^n$  is in the closure of  $\bigcap_K^r(U, \mathbb{R}^n; E)$ . Let  $\{y_k\}$  be a sequence in  $\mathbb{R}^n$  tending to 0, such that each  $\pi(y_k)$  is a regular value of  $\pi g: U \rightarrow \mathbb{R}^n/\mathbb{R}^a$ . Define

$$\begin{aligned} g_k: U &\rightarrow \mathbb{R}^n, \\ g_k(x) &= g(x) - y_k. \end{aligned}$$

Then  $g_k \rightarrow g$  in  $C_w^r(U, \mathbb{R}^n)$ . Since  $g_k \notin \mathbb{R}^a$ , this shows that  $\bigcap_K^r(U, \mathbb{R}^n)$  is dense in  $C_w^r(U, \mathbb{R}^n)$ .

QED

*Proof of the Transversality Theorem 2.1.* First we assume that  $A$  is a closed submanifold and prove Theorem 2.1(b). We begin with the case  $\partial N = \emptyset$ .

It is easy to verify that for  $1 \leq r \leq \infty$  the function

$$\mathcal{X}: (L, U, V) \mapsto \bigcap_L^r(U, V; A \cap V)$$

is a  $C^r$  mapping class on  $(M, N)$ . Under the assumption that  $\partial N = \emptyset$  and  $A$  is closed,  $\mathcal{X}$  is rich. This follows from Lemma 2.3 by taking  $\mathcal{U}$  to be any open cover of  $M$  and  $\mathcal{V}$  to be an atlas of coordinate domains on  $N$  that come from submanifold charts for  $(N, A)$ . It follows from Theorem 2.2 that  $\bigcap_L^r(M, N; A)$  is strongly dense and open, and weakly dense and open if  $L$  is compact.

Suppose now that  $A$  is still closed, but  $\partial N \neq \emptyset$ . We may assume  $N \subset \mathbb{R}^n$  as a closed submanifold. Then the weak and strong topologies on  $C^r(M, N)$  are those it inherits from the weak and strong topologies  $C^r(M, \mathbb{R}^n)$ . We have already proved that  $\bigcap^r(M, \mathbb{R}^n; A)$  is strongly open, since  $A \subset \mathbb{R}^n$  is closed and  $\partial \mathbb{R}^n = \emptyset$ ; therefore the equation

$$\bigcap^r(M, N; A) = C^r(M, N) \cap \bigcap^r(M, \mathbb{R}^n; A)$$

shows that  $\bigcap^r(M, N; A)$  is strongly open in  $C^r(M, N)$ . A similar argument shows that  $\bigcap_L^r(M, N; A)$  is strongly open, and weakly open if  $L$  is compact. For density put  $N_0 = N - \partial N$ ,  $A_0 = A - \partial N$ , so that  $\partial N_0 = \emptyset$  and  $A_0 \subset N_0$  is a closed submanifold. Then  $\bigcap_L^r(M, N_0; A_0)$  is strongly dense in  $C^r(M, N_0)$ , and weakly dense when  $L$  is compact. Now  $C^r(M, N_0)$  is a subset of  $C^r(M, N)$  which is both strongly and weakly dense. Therefore  $\bigcap_L^r(M, N_0; A_0)$  is a subset of  $\bigcap_L^r(M, N; A)$  which is strongly dense, and weakly dense when  $L$  is compact. This proves Theorem 2.1(b) in full generality.

To prove Theorem 2.1(a) when  $A$  is not closed, let  $A_k$  be a countable family of compact coordinate disks on  $A$ . Then

$$\bigcap^r(M, N; A) = \bigcap_{k=1}^{\infty} \bigcap^r(M, N; A_k).$$

Since  $A_k$  is closed,  $\bigcap^r(M, N; A_k)$  is strongly dense and open which proves  $\bigcap^r(M, N; A)$  strongly residual. Write  $M = \bigcup_{j=1}^{\infty} M_j$  where each  $M_j$  is compact. Then

$$\bigcap^r(M, N; A_k) = \bigcap_{j=1}^{\infty} \bigcap^r M_j(M, N; A_k).$$

This makes each  $\bigcap^r(M, N; A_k)$  weakly residual; hence each  $\bigcap^r(M, N; A_k)$  is weakly residual. Finally,  $\bigcap^r(M, N; A)$  is weakly residual. The proof of Theorem 2.1 is complete.

QED

Transversality is often used to put submanifolds  $A, B \subset N$  in *general position*; this means that the inclusion map  $B \rightarrow N$  is transverse to  $A$ , or equivalently, that  $A_x + B_x = N_x$  when  $x \in A \cap B$ . Note that this condition is symmetric. If  $A$  and  $B$  are in general position then  $A \cap B$  is a submanifold of both  $A$  and  $B$ .

**2.4. Theorem.** *Let  $A, B$  be  $C^r$  submanifolds of  $N$ ,  $1 \leq r \leq \infty$ . Every neighborhood of the inclusion  $i_B: B \rightarrow N$  in  $C_S^r(B, N)$  contains an embedding which is transverse to  $A$ .*

*Proof.* From the approximation results of Chapter 2 we may assume  $r = \infty$ . The theorem follows from Theorem 2.1 and the openness of embeddings.

QED

Frequently one wants a map  $M \rightarrow N$  to be transverse not just to one submanifold, but to each of several submanifolds  $A_0, \dots, A_q$ . If each  $A_i$  is closed, the set of such maps is open and dense; this follows from openness and density of  $\bigcap^r(M, N; A_i)$ . But if the  $A_i$  are not closed we may lose openness. (But see Exercises 15 and 8.)

**2.5. Theorem.** *Let  $A_0, \dots, A_q$  be  $C^r$  submanifolds of  $N$ ,  $1 \leq r \leq \infty$ . The set  $\bigcap^r(M, N; A_0, \dots, A_q)$  of  $C^r$  maps  $M \rightarrow N$  that are transverse to each  $A_i$ ,  $i = 0, \dots, q$ , is residual in  $C_S^r(M, N)$ .*

*Proof.* Since each set  $\bigcap^r(M, N; A_k)$  is residual,  $k = 0, \dots, q$ , their intersection is residual.

QED

The following typical application of transversality is frequently used. For integers  $n \geq k \geq 0$ , let  $V_{n,k}$  denote the *Stiefel manifold* of linear maps  $\mathbb{R}^k \rightarrow \mathbb{R}^n$  of rank  $k$ . It is an open submanifold of the vector space  $L(\mathbb{R}^k, \mathbb{R}^n)$ . An element of  $V_{n,k}$  can be thought of as a  $k$ -frame, that is, a  $k$ -tuple of independent vectors in  $\mathbb{R}^n$ : the image of the standard basis of  $\mathbb{R}^k$ .

**2.6. Theorem.** *Let  $M$  be a  $q$ -dimensional manifold and  $K \subset M$  a closed set. If  $q \leq n - k$  then every map  $K \rightarrow V_{n,k}$  extends to a map  $M \rightarrow V_{n,k}$ .*

*Proof.* We assume  $n > k > 0$ , the other cases being trivial. By covering  $M$  with a locally finite family of coordinate disks and making successive extensions, one reduces the theorem to the case  $M = D^q$ . By Tietze's theorem  $f$  extends to  $g: D^q \rightarrow L(\mathbb{R}^k, \mathbb{R}^n)$ . Let  $A = L(\mathbb{R}^k, \mathbb{R}^n) - V_{n,k}$ . Then  $g^{-1}(A)$  is closed and  $K \cap g^{-1}(A) = \emptyset$ . By the relative approximation theorem (Theorem 2.2.5) we assume:  $g$  is  $C^\infty$  on an open set  $M_0 \subset D^q$  containing  $g^{-1}(A)$ , such that  $K$  is disjoint from the closure of  $M_0$ , and  $g = f$  on  $K$ .

The subset  $A \subset L(\mathbb{R}^k, \mathbb{R}^n)$  is the union of the subsets

$$L(k, n; \rho) = \{T \in L(\mathbb{R}^k, \mathbb{R}^n) : \text{rank } T = \rho\},$$

$\rho = 0, \dots, k - 1$ . Each of these is a submanifold. To see this fix  $T \in L(k, n; \rho)$ . Let  $i: \mathbb{R}^p \rightarrow \mathbb{R}^k$  be a linear injection transverse to the kernel of  $T$ , and let  $p: \mathbb{R}^n \rightarrow \mathbb{R}^p$  a linear surjection whose kernel is transverse to the image of  $T$ . For any  $S \in L(k, n; \rho)$  in a sufficiently small neighborhood  $U$  of  $T$ , the linear map

$$pSi: \mathbb{R}^p \rightarrow \mathbb{R}^p$$

is an isomorphism. Define

$$\begin{aligned} \varphi: U &\rightarrow G_{k, k-\rho} \times L(\mathbb{R}^p, \mathbb{R}^p) \times G_{n, \rho}, \\ S &\mapsto (\text{Ker } S, pSi, \text{im } S); \end{aligned}$$

here  $G_{m, \ell}$  is the Grassmann manifold of  $\ell$ -planes in  $\mathbb{R}^m$ : its dimension is  $\ell(m - \ell)$ . Then  $\varphi$  maps  $U$  homeomorphically onto an open set. All possible maps of this type form an atlas on  $L(k, n; \rho)$ . Since the inverse of  $\varphi$  is a  $C^\infty$  map into  $L(k, n)$ , it follows that  $L(k, n; \rho)$  is a  $C^\infty$  submanifold of  $L(\mathbb{R}^k, \mathbb{R}^n)$  of dimension

$$\begin{aligned} d_\rho &= (k - \rho)\rho + \rho^2 + \rho(n - \rho) \\ &= nk - (n - \rho)(k - \rho), \end{aligned}$$

and codimension  $(n - \rho)(k - \rho)$ . This holds for  $0 \leq \rho \leq \min\{k, n\}$ . Note that  $d_\rho$  increases with  $\rho$ .

Put  $A_\rho = L(k, n; \rho)$ . The map  $g$  can be assumed to be transverse to each  $A_\rho$ . Now

$$d_{k-1} = (k - 1)(n + 1).$$

Therefore if  $\rho \leq k - 1$ ,

$$\dim L(\mathbb{R}^k, \mathbb{R}^n) - d_\rho \geq kn - (k - 1)(n + 1) = n - k + 1.$$

It follows that if  $\dim M < n - k + 1$ , the image of  $g$  misses  $A_0 \cup \dots \cup A_{k-1}$ ; and so  $g(M) \subset V_{n,k}$ .

QED

Frequently one deals not with all  $C^r$  maps  $M \rightarrow N$  but only with a family of maps parametrized by another manifold  $V$ . Thus one has a map  $F: V \rightarrow C^r(M, N)$  and a submanifold  $A \subset N$ ; it required to find  $v \in V$  such that the map

$$F(v) = F_v: M \rightarrow N$$

is transverse to  $A$ . Of course restrictions must be placed on  $F$ . We call the following result the *parametric transversality theorem*. For simplicity we state it only for manifolds without boundary.

**2.7. Theorem.** *Let  $V, M, N$  be  $C^r$  manifolds without boundary and  $A \subset N$  a  $C^r$  submanifold. Let  $F: V \rightarrow C^r(M, N)$  satisfy the following conditions:*

- (a) *the evaluation map  $F^{ev}: V \times M \rightarrow N$ ,  $(v, x) \mapsto F_v(x)$ , is  $C^r$ ;*
- (b)  *$F^{ev}$  is transverse to  $A$ ;*
- (c)  *$r > \max\{0, \dim M + \dim A - \dim N\}$ .*

Then the set

$$\pitchfork(F; A) = \{v \in V : F_v \pitchfork A\}$$

is residual and therefore dense. If  $A$  is closed in  $N$  and  $F$  is continuous for the strong topology on  $C^r(M, N)$  then  $\pitchfork(F, A)$  is also open.

*Proof.* The last statement follows from openness of  $\pitchfork^r(M, N; A)$ . To prove the rest of the theorem let  $W = (F^r)^{-1}(A) \subset V \times M$ . By (a),  $W$  is a  $C^r$  submanifold of  $V \times M$ . Let  $\pi: V \times M \rightarrow V$  be the projection. It is readily verified that  $F_v \pitchfork A$  is and only if  $v \in V$  is a regular value for the  $C^r$  map  $\pi|_W: W \rightarrow V$ . The dimension of  $W$  is  $\dim V + \dim M - \dim N + \dim A$ . The theorem follows from Morse–Sard.

QED

In many situations parametric transversality is not sufficient; instead of a map from a manifold to a function space, one must deal with a map defined on another function space. Often the domain of the map is an infinite dimensional manifold; in this case there is a generalization of Theorem 2.7 due to R. Abraham [1].

A common situation concerns the jet map

$$j^r: C^s(M, N) \rightarrow C^{s-r}(M, J^r(M, N)).$$

Here  $1 \leq r < s \leq \infty$ . One is given a submanifold  $A \subset J^r(M, N)$  and tries to approximate a  $C^s$  map  $g: M \rightarrow N$  by another  $C^s$  map  $h$  whose prolongation  $J^r h: M \rightarrow J^r(M, N)$  is transverse to  $A$ . Denote the set of such maps  $h$  by  $\pitchfork^s(M, N; j^r A)$ .

**2.8. Jet Transversality Theorem.** *Let  $M, N$  be  $C^\infty$  manifolds without boundary, and let  $A \subset J^r(M, N)$  be a  $C^\infty$  submanifold. Suppose  $1 \leq r < s \leq \infty$ . Then  $\pitchfork^s(M, N; j^r A)$  is residual and thus dense in  $C^s_3(M, N)$ , and open if  $A$  is closed.*

*Proof.* Suppose  $A$  is closed. Openness follows from openness of  $\pitchfork^{s-r}(M, J^r(M, N); A)$ . To prove density let  $U \subset M, V \subset N$  be open sets and let  $L \subset U$  be closed in  $M$ . Define

$$\mathcal{X}_L(U, V) = \{f \in C^s(U, V) : J^r f \pitchfork_L A\}.$$

One verifies easily that  $\mathcal{X}$  is a  $C^s$  mapping class on  $(M, N)$ . By the globalization Theorem 2.2 it suffices to prove  $\mathcal{X}$  rich. For the coverings  $\mathcal{U}, \mathcal{V}$  in the definition of rich choose any open coverings by coordinate domains. It now suffices to prove that if  $U \subset \mathbb{R}^m$  is an open subset and  $A \subset J^r(U, \mathbb{R}^n)$  is a closed submanifold, then  $\pitchfork^s(U, \mathbb{R}^n; j^r A)$  is open and dense in  $C^s_W(U, \mathbb{R}^n)$ . Moreover it is enough to prove this for  $s$  finite,  $s > r$ . Fix  $f \in C^s(U, \mathbb{R}^n)$ . Openness is obvious. The strategy for denseness is to find a  $C^\infty$  manifold  $X$  and a map  $\alpha: X \rightarrow C^s_W(U, \mathbb{R}^n)$  with  $f \in \alpha(x)$ , and then apply parametric transversality to the composition

$$F: X \xrightarrow{\alpha} C^s(U, \mathbb{R}^n) \xrightarrow{j^r} C^{s-r}(U, J^r(U, \mathbb{R}^n)).$$

This requires that the evaluation map of  $F$ ,

$$F^\circ: X \times U \rightarrow J^r(U, \mathbb{R}^n)$$

be transverse to  $A$  and sufficiently differentiable. In fact  $F^\circ$  will be a  $C^s$  submersion.

Put  $X = J^s_0(\mathbb{R}^m, \mathbb{R}^n)$ . Every element of  $X$  is the  $s$ -jet at 0 of a unique map  $g: \mathbb{R}^m \rightarrow \mathbb{R}^n$  whose coordinate maps  $g_1, \dots, g_n$  are polynomials of degree  $\leq s$  in the coordinates of  $\mathbb{R}^m$ . We identify the elements of  $X$  with such maps  $g$ .

Define  $\alpha: X \rightarrow C^s_W(U, \mathbb{R}^n)$ ,  $g \mapsto f + g|_U$  and

$$F = f^\circ \circ \alpha: X \rightarrow C^{s-r}(U, J^r(U, \mathbb{R}^n)).$$

Then  $F(0) = f$ . To compute  $F^\circ$  make the natural identification

$$J^r(U, \mathbb{R}^n) = J^r_0(\mathbb{R}^m, \mathbb{R}^n) \times U.$$

Then

$$F^\circ: J^s_0(\mathbb{R}^m, \mathbb{R}^n) \times U \rightarrow J^r_0(\mathbb{R}^m, \mathbb{R}^n) \times U$$

is given by

$$(j^s_0(g), x) \mapsto (j^r_0(g + f), x).$$

The map

$$\begin{aligned} \beta: J^s_0(\mathbb{R}^m, \mathbb{R}^n) &\rightarrow J^r_0(\mathbb{R}^m, \mathbb{R}^n) \\ j^s_0(g) &\mapsto j^r_0(g + f) \end{aligned}$$

is affine, hence  $F$  is  $C^\infty$ . Moreover the derivative of  $\beta$  at any point is the “forgetful” linear map

$$\begin{aligned} J^s_0(\mathbb{R}^m, \mathbb{R}^n) &\rightarrow J^r_0(\mathbb{R}^m, \mathbb{R}^n), \\ j^s_0(g) &\mapsto j^r_0(g) \end{aligned}$$

which is surjective. Thus  $F^\circ \pitchfork A$ ; by Theorem 2.7 it follows that

$$\{x \in X : j^r(\alpha(x)) \pitchfork A\}$$

is dense in  $X$ . Since

$$\alpha: X \rightarrow C^s_W(U, \mathbb{R}^n)$$

is continuous it follows that  $f$  is in the closure of

$$\{h \in C^s_W(U, \mathbb{R}^n) : j^r h \pitchfork A\}.$$

This proves that  $\mathcal{X}$  is rich; hence for closed  $A$ , Theorem 2.8 follows from

Theorem 2.2. If  $A$  is not closed write  $A = \bigcup_{k=1}^{\infty} A_k$  where each  $A_k$  is a compact coordinate disk in  $A$ . Then each  $\pitchfork^s(M, N; j^r A_k)$  is dense and open in  $C^s_3(M, N)$ . By Baire their intersection, which is  $\pitchfork^s(M, N; j^r A)$ , is dense.

QED

Just as with ordinary transversality, jet transversality extends to submanifold families; we leave the proof of the following result to the reader.

**2.9. Theorem.** Let  $A_0, \dots, A_q$  be  $C^\infty$  submanifolds of  $J^r(M, N)$ . If  $1 \leq r < s \leq \infty$  then the set

$$\{f \in C^s(M, N) : j^r f \pitchfork A_k, k = 0, \dots, q\}$$

is residual in  $C^s_5(M, N)$ .

As an application consider anew the question of density of immersions in  $C^2_5(M, N)$ . Let  $A_k \subset J^1(M, N)$  be the set of 1-jets of rank  $k$ . Let  $m = \dim M$ ,  $n = \dim N$ . Then  $A_0, \dots, A_{m-1}$  is a  $C^\infty$  submanifold family. A map  $f: M \rightarrow N$  is an immersion if and only if the image of  $j^1 f$  misses  $A_0 \cup \dots \cup A_{m-1}$ . The set of  $f \in C^2(M, N)$  such that  $j^1 f$  is transverse to  $A_0, \dots, A_{m-1}$  is dense in  $C^2_5(M, N)$ . If, for  $i = 0, \dots, m-1$ ,  $\dim A_i + \dim M < \dim J^1(M, N)$ , such transversality implies that  $f$  is an immersion. As in the proof of Theorem 2.5 one computes that (assuming  $m \leq n$ )

$$\begin{aligned} \dim A_i &\leq \dim A_{m-1} = 2m + mn - 1, \\ \dim J^1(M, N) &= mn + m + n. \end{aligned}$$

Denseness of immersions is thus implied by

$$(2m + mn - 1) + m < mn + m + n$$

which is the same as  $n \geq 2m$ , exactly the condition found previously.

This proof is not very satisfying geometrically; it gives no hint as to how the immersion is constructed. Nevertheless it shows the power of transversality: the existence and even the denseness of immersions is proved by merely counting dimensions!

**Exercises**

1. An immersion  $f: M \rightarrow N$  has *clean double points* if whenever  $x, y$  are distinct points of  $M$  with  $f(x) = f(y)$ , they have disjoint neighborhoods  $U, V$  such that  $f|_U$  and  $f|_V$  are embeddings, and the submanifolds  $f(U), f(V)$  are in general position (as defined in Section 3.2). The set of immersions that have clean double points is dense and open in  $\text{Imm}^r_5(M, N)$ ,  $1 \leq r \leq \infty$ .

2. An immersion  $f: M \rightarrow N$  is in *general position* if for any integer  $k \geq 2$ , whenever  $f(x_1) = \dots = f(x_k) = y$  and the points  $x_1, \dots, x_k$  are distinct, then  $N_y$  is spanned by  $Tf(M_{x_1})$  and

$$Tf(M_{x_2}) \cap \dots \cap Tf(M_{x_{k-1}}).$$

The set of proper immersions which are in general position is dense and open in  $\text{Imm}^r_5(M, N)$ ,  $1 \leq r \leq \infty$ .

3. If  $f: M \rightarrow N$  is transverse to a submanifold complex  $A_0, \dots, A_q$  then  $f^{-1}(A_0 \cup \dots \cup A_q)$  is a submanifold complex (see Ex. 15).

4. There is a dense open set  $\mathcal{S} \subset C^2_5(M^m, N^n)$  such that if  $f \in \mathcal{S}$ , then:

(a) for each  $\rho = 0, \dots, \min(m, n)$  the set

$$R(f, \rho) = \{x \in M^m : \text{rank } T_x f = \rho\}$$

is a submanifold of  $M$ ;

(b)  $R(f, \rho) = \emptyset$  if  $(m - \rho)(n - \rho) > m$ ;

(c) if  $(m - \rho)(n - \rho) \leq m$  then

$$\text{codim } R(f, \rho) = (m - \rho)(n - \rho);$$

(d) the submanifolds

$$R(f, 0), \dots, R(f, \min(m, n))$$

form a submanifold complex (see Ex. 15).

5. Generically, a  $C^1$  map  $f: M^m \rightarrow N^{2m-1}$  has rank  $> m - 2$  everywhere, and the set where  $f$  has rank  $m - 1$  is a closed 0-dimensional submanifold (perhaps empty).

\*6. A map  $f: \mathbb{R}^2 \rightarrow \mathbb{R}^2$  has a *cusp* at  $x \in \mathbb{R}^2$  if (i)  $Df_x$  has rank 1, (ii)  $j^1 f$  is transverse at  $x$  to the 1-jets of rank 1, and (iii)  $\text{Ker } Df_x$  is tangent to  $R(f, 1)$  (see Exercise 4).

(a)  $(0, 0)$  is a cusp of the map  $g(x, y) = (x^3 - xy, y)$ .

(b) If  $U \subset \mathbb{R}^2$  is any neighborhood of  $(0, 0)$ , there is a weak  $C^2$  neighborhood  $\mathcal{A}$  of  $g$  such that every map in  $\mathcal{A}$  has a cusp in  $U$ .

\*7. A *k-fold point* of a map  $f: M \rightarrow N$  is a point  $x \in M$  such that there are  $k$  distinct points  $x = x_1, \dots, x_k$  with  $f(x_1) = \dots = f(x_k)$ . Let  $M$  and  $N$  be manifolds such that

$$\frac{k+1}{k} < \frac{\dim N}{\dim M} \leq \frac{k}{k-1}, \quad k \geq 2.$$

(a) There is a dense open set of maps in  $C^r_5(M, N)$ ,  $1 \leq r \leq \infty$ , having no  $(k+1)$ -fold points, and whose set of  $k$ -fold points is a closed  $C^r$  submanifold of dimension  $km - (k-1)n$  (possibly empty).

(b) There is a nonempty open set of maps in  $C^r_5(M, N)$ , each having a nonempty set of  $k$ -fold points.

8. The transversality Theorems 2.5, 2.8, 2.9, combined with Ex. 15, take the following forms for weak topologies:

(a) In Theorem 2.5 the set of maps  $M \rightarrow N$  transverse to  $A_0, \dots, A_q$  is residual in  $C^r_w(M, N)$ , and open if  $\cup A_i$  is compact and  $\{A_i\}$  is a submanifold complex.

(b) In Theorem 2.8,  $\phi^s(M, N; j^r A)$  is residual in  $C^r_w(M, N)$ , and open if  $A$  is compact.

(c) In Theorem 2.9, the set of maps whose  $r$ -jets are transverse to  $A_0, \dots, A_q$  is residual in  $C^r_w(M, N)$ , and open if  $\cup A_i$  is compact and  $\{A_i\}$  is a submanifold complex.

9. Consider  $G_{s,k}$  embedded in  $G_{s+1,k+1}$  by identifying a  $k$ -plane  $P \subset \mathbb{R}^s$  with  $P \times \mathbb{R} \subset \mathbb{R}^s \times \mathbb{R} = \mathbb{R}^{s+1}$ . If  $\dim M \leq k$ , every map  $f: M \rightarrow G_{s+1,k+1}$  is homotopic to a map  $g: M \rightarrow G_{s,k}$ . If  $\dim M < k$ , the homotopy class of  $g$  is uniquely determined by that of  $f$ .

10. Let  $F: V \rightarrow C^r(M, N)$  be such that  $F^\circ: V \times M \rightarrow N$  is  $C^r$  (see the parametric transversality Theorem 2.7). Then  $F$  is continuous for the strong topology if  $V$  is compact; or, more precisely, if and only if  $F$  is constant outside a compact subset of  $V$ .

11. In the jet transversality Theorem 2.8, the assumption that  $A \subset J^r(M, N)$  be a  $C^s$  submanifold can be relaxed to:  $A$  is a  $C^s$  submanifold, for a certain  $k < \infty$  depending on  $r, s, \dim M$ , and  $\dim N$ . Compute  $k$ .

\*\*\*12. Are the parametric and jet transversality Theorems 2.7 and 2.8 true when  $V, M, N$ , and  $A$  are allowed to have boundaries? (The proof of Theorem 2.8 uses Theorem 2.7. In Theorem 2.7 there are two difficulties: the first is that  $V \times M$  is not a manifold if  $V$  and  $M$  are  $\partial$ -manifolds; the second, and more troublesome, is that  $(F^\circ)^{-1}(A)$  might not be a submanifold if  $N$  and  $A$  are  $\partial$ -manifolds.)

13. Let  $p: V \rightarrow M$  be a  $C^1$  submersion, and  $f: M \rightarrow V$  a  $C^r$  section of  $p$  (that is,  $pf = 1_M$ ),  $1 \leq r \leq \infty$ . Let  $A \subset V$  be a  $C^r$  submanifold. Then every neighborhood of  $f$  in  $C^r_5(M, V)$  contains a  $C^r$  section transverse to  $A$ . (See Ex. 3, Section 2.2.)

14. Let  $g: A \rightarrow N$  be a map. A map  $f: M \rightarrow N$  is *transverse to  $g$* , written  $f \pitchfork g$  if, whenever  $f(x) = g(y) = z$ , the images of  $T_x f$  and  $T_y g$  span  $N_z$ .

(a)  $f \pitchfork g$  if and only if the map  $f \times g: M \times A \rightarrow N \times N$  is transverse to the diagonal.

\*\*\*(b) Is it true (as seems likely) that the set  $\{f \in C^\infty(M, N) : f \pitchfork g\}$  is residual in  $C_S^\infty(M, N)$  and open if  $g$  is proper?

15. Submanifolds  $A_0, \dots, A_q \subset N$  form a *submanifold complex* if (i)  $A_0$  is closed and

$$\bar{A}_{i+1} - A_{i+1} \subset A_0 \cup \dots \cup A_i;$$

(ii)  $\dim A_{i-1} < \dim A_i$ ; (iii) Let  $0 \leq i < j \leq q$ ; put  $d = \dim A_i$ . If a sequence  $\{x_n\}$  in  $A_j$  converges to  $y$  in  $A_i$ , there is a sequence  $E_n$  of  $d$ -planes,  $E_n \subset T_{x_n} A_j$ , converging to  $T_y A_i$ .

(a) The set of  $C^\infty$  maps  $M \rightarrow N$  transverse to all the  $A_i$ , is dense and open.

\*(b) The submanifolds  $A_p$  in the proof of Theorem 2.5 form a submanifold complex.

## Chapter 4

### Vector Bundles and Tubular Neighborhoods

The paradox is now fully established that the utmost abstractions are the true weapons with which to control our thought of concrete fact.

—A. N. Whitehead, *Science and the Modern World*, 1925

The Committee which was set up in Rome for the unification of vector notation did not have the slightest success, which was only to have been expected.

—F. Klein, *Elementary Mathematics from an Advanced Standpoint*, 1908

Deux surfaces fermées, par exemple de genre 0, situées dans une variété à 4 dimensions, sont toujours équivalentes, mais, comme nous le voyons, leurs entourages ne le sont pas nécessairement.

—Heegard, *Dissertation*, 1898.

Although the concept of tangent bundle was defined in the first chapter, until now we have made only minimal use of it. In this chapter we abstract certain features of the tangent bundle, thus defining a mixed topological-algebraic object called a vector bundle. Most of the deep invariants of a manifold are intimately linked to the tangent bundle; their development requires a general theory of vector bundles.

A vector bundle can be thought of a family  $\{E_x\}_{x \in B}$  of disjoint vector spaces parameterized by a space  $B$ . The union of these vector spaces is a space  $E$ , and the map  $p: E \rightarrow B$ ,  $p(E_x) = x$  is continuous. Moreover  $p$  is *locally trivial* in the sense that locally (with respect to  $B$ ),  $E$  looks like a product with  $\mathbb{R}^n$ : there are open sets  $U$  covering  $B$  and homeomorphisms  $p^{-1}(U) \approx U \times \mathbb{R}^n$ , mapping each fibre  $E_x$  linearly onto  $x \times \mathbb{R}^n$ . A *morphism* from one vector bundle to another is a map taking fibres linearly into fibres.

A vector bundle is similar to a manifold in that both are built up from elementary objects glued together by maps of a specified kind. For manifolds the elementary objects are open subsets of  $\mathbb{R}^n$ ; the gluing maps are diffeomorphisms. For vector bundles the elementary objects are "trivial" bundles  $U \times \mathbb{R}^n$ ; the gluing maps are morphisms  $U \times \mathbb{R}^n \rightarrow U \times \mathbb{R}^n$  of the form  $(x, y) \mapsto (x, g(x)y)$  where  $g: U \rightarrow GL(n)$ .

In Section 4.1 the basic definitions are given and the covering homotopy theorem is proved. This basic result is the link between vector bundles and homotopy.

In both manifolds and vector bundles, linear maps play a crucial role. But whereas linear maps enter into manifolds in a rather subtle way, as

derivatives, the linearity in vector bundles is closer to the surface. This makes the category of vector bundles far more flexible than that of manifolds; as a consequence, vector bundles are considerably easier to analyze. Many natural constructions can be made with vector bundles which are impossible for manifolds, such as direct sum, quotients and pullbacks. These are discussed in Section 4.2.

In Section 4.3 we prove an important classification theorem for vector bundles. This theorem says that for given integers  $k, n \geq 0$  there is an explicitly defined  $k$ -plane bundle  $\xi \rightarrow G$  which is *universal* in the following sense: for every  $k$ -plane bundle  $\eta \rightarrow M$  where  $M$  is a manifold of dimension  $\leq n$ , there is a map  $f: M \rightarrow G$  such that  $\xi$  is isomorphic to  $f^*\eta$  (the pullback of  $\eta$  by  $f$ ), and  $f$  is unique up to homotopy. This means that isomorphism classes of  $k$ -plane bundles over  $M$  are in natural one-to-one correspondence with homotopy classes of maps  $M \rightarrow G$ . In this way all questions about vector bundles over  $M$  are translated into questions about homotopy classes of maps  $M \rightarrow G$ .

Section 4.4 introduces the important concept of orientation for vector spaces, vector bundles and manifolds. The orientability or nonorientability of a manifold is an important invariant. As applications some nonembedding theorems are proved.

In Sections 4.5 and 4.6 a new connection between vector bundles and the topology of manifolds is introduced: the tubular neighborhood. If  $M \subset N$  is a neat submanifold,  $M$  has a neighborhood in  $N$  which looks like the normal vector bundle of  $M$  in  $N$ ; moreover, such neighborhoods are essentially unique. Thus the study of the kinds of neighborhoods that  $M$  can have as a submanifold of a larger manifold, is reduced to the classification of vector bundles over  $M$ . For example, the problem of whether the inclusion  $M \subset N$  can be approximated by embeddings  $M \hookrightarrow N - M$  is equivalent to the problem of whether the normal bundle of  $M$  in  $N$  has a nonvanishing section.

Section 4.7 exploits tubular neighborhoods to prove that every compact manifold without boundary has a compatible real analytic structure.

### 1. Vector Bundles

Let  $p: E \rightarrow B$  be a continuous map. A *vector bundle chart* on  $(p, E, B)$  with domain  $U$  and dimension  $n$  a homeomorphism  $\varphi: p^{-1}(U) \approx U \times \mathbb{R}^n$  where  $U \subset B$  is open, such that the diagram

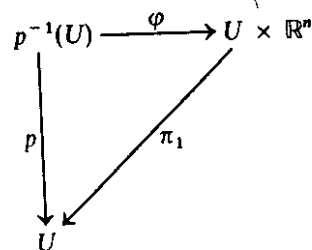

commutes; here  $\pi_1(x, y) = x$ . For each  $x \in U$  we define the homeomorphism  $\varphi_x$  to be the composition

$$\varphi_x: p^{-1}(x) \xrightarrow{\varphi} x \times \mathbb{R}^n \rightarrow \mathbb{R}^n.$$

Thus if  $y \in p^{-1}(x)$  we have the formula

$$\varphi(y) = (x, \varphi_x(y)).$$

A *vector bundle atlas*  $\Phi$  on  $(p, E, B)$  is a family of vector bundle charts on  $(p, E, B)$  with values in the same  $\mathbb{R}^n$ , whose domains cover  $B$ , and such that whenever  $(\varphi, U)$  and  $(\psi, V)$  are in  $\Phi$  and  $x \in U \cap V$ , the homeomorphism

$$\psi_x \varphi_x^{-1}: \mathbb{R}^n \rightarrow \mathbb{R}^n$$

is linear. The map

$$\begin{aligned} U \cap V &\rightarrow GL(n), \\ x &\rightarrow \psi_x \varphi_x^{-1} \end{aligned}$$

is required to be continuous; it is called the *transition function* of the pair of charts  $(\varphi, U), (\psi, V)$ . If  $\Phi = \{\varphi_i, U_i\}_{i \in A}$  we obtain a family  $\{g_{ij}\}$  of transition function,

$$g_{ij}: U_i \cap U_j \rightarrow GL(n).$$

These maps satisfy the identities

$$\begin{aligned} g_{ij}(x)g_{jk}(x) &= g_{ik}(x) \quad (x \in U_i \cap U_j \cap U_k), \\ g_{ii}(x) &= 1 \in GL(n). \end{aligned}$$

The family  $\{g_{ij}\}$  is also called the *cocycle* of the vector bundle atlas  $\Phi$ . A maximal vector bundle atlas  $\Phi$  is a *vector bundle structure* on  $(p, E, B)$ . We then call  $\xi = (p, E, B, \Phi)$  a *vector bundle* having (fibre) dimension  $n$ , projection  $p$ , total space  $E$  and base space  $B$ . Often  $\Phi$  is not explicitly mentioned. In fact we may denote  $\xi$  by  $E$ , or  $E$  by  $\xi$ . Sometimes it is convenient to put  $E = E\xi, B = B\xi$ , etc. An atlas for  $\xi$  will mean a subatlas of  $\Phi$ .

The *fibre* over  $x \in B$  is the space  $p^{-1}(x) = \xi_x = E_x$ . We give  $\xi_x$  the vector space structure making each  $\varphi_x: \xi_x \rightarrow \mathbb{R}^n$  an isomorphism; this structure is independent of the choice of  $(\varphi, U) \in \Phi$ . Thus  $E$  is a "bundle" of vector spaces. To indicate the dimension  $n$  we sometimes call  $\xi$  an *n-plane bundle*.

If  $A \subset B$  is any subset we may denote  $p^{-1}(A)$  by  $\xi_A, \xi|A, E_A$ , or  $E|A$ . The *restriction* of  $\xi$  to  $A$  is the vector bundle

$$\xi|A = (p|E_A, E_A, A, \Phi_A)$$

where  $\Phi_A$  contains all charts of the form

$$\varphi|p^{-1}(A \cap U): E|A \cap U \rightarrow (A \cap U) \times \mathbb{R}^n,$$

where  $(\varphi, U) \in \Phi$ .

The *zero section* of  $\xi$  is the map  $Z: B \rightarrow E$  which to  $x$  assigns the zero element of  $\xi_x$ . Often we call the subspace  $Z(B) \subset E$  the zero section. It is frequently useful to identify  $B$  with  $Z(B)$  via  $Z$ .

Let  $\xi_i = (p_i, E_i, B_i, \Phi_i)$  be a vector bundle,  $i = 0, 1$ . A fibre map  $F: \xi_0 \rightarrow \xi_1$  is a map  $F: E_0 \rightarrow E_1$  which covers a map  $f: B_0 \rightarrow B_1$ , that is, there is a commuting diagram

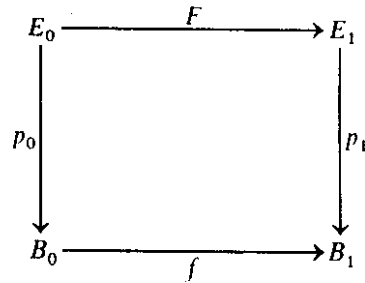

Thus if  $x \in B_0$  and  $f(x) = y$ , then  $F$  maps the fibre over  $x$  into the fibre over  $y$  by a map  $F_x: \xi_{0x} \rightarrow \xi_{1y}$ .

If each map  $F_x$  is linear we call  $F$  a morphism of vector bundles. If  $F$  is a morphism and each  $F_x$  is injective,  $F$  is a *monomorphism*; if each  $F_x$  is surjective,  $F$  is an *epimorphism*; while if each  $F_x$  is bijective we call  $F$  a *bimorphism* or *vector bundle map*. If  $F$  is a bimorphism covering a homeomorphism  $f: B_0 \rightarrow B_1$  then  $F$  is an *equivalence*. If  $B_0 = B_1 = B$  and  $f = 1_B$  then  $F$  is an *isomorphism*, and we may write  $\xi_0 \cong \xi_1$ .

The *trivial*  $n$ -dimensional vector bundle over  $B$  is

$$\varepsilon_B^n = (p, B \times \mathbb{R}^n, B, \Phi)$$

where  $p: B \times \mathbb{R}^n \rightarrow B$  is the natural projection and  $\Phi$  is the unique maximal vector bundle atlas containing the identity map of  $B \times \mathbb{R}^n$ . More generally, a vector bundle  $\xi$  is called *trivial* if it is isomorphic to  $\varepsilon_B^n$ . Such an isomorphism is a *trivialization* of  $\xi$ .

Fix a differentiability class  $C^r$ ,  $1 \leq r \leq \omega$ . The above definitions make sense if all spaces involved are required to be  $C^r$  manifolds, and maps are required to be  $C^r$  maps. In this way we obtain  $C^r$  vector bundles, morphisms and bundle maps. We also interpret  $C^0$  vector bundle to mean vector bundle as originally defined; similarly for  $C^0$  morphisms, etc. We denote  $C^r$  isomorphism by  $\cong_r$ .

The prime example of a  $C^r$  vector bundle is the tangent bundle  $p: TM \rightarrow M$  of a  $C^{r+1}$  manifold  $M$ . For each chart  $\phi: U \rightarrow \mathbb{R}^n$  we define a vector bundle chart

$$p^{-1}(U) \rightarrow U \times \mathbb{R}^n$$

by sending the tangent vector  $X \in T_x M$  to  $(x, D\phi_x(X))$ . If  $f: M \rightarrow N$  is a  $C^{r+1}$  map then  $Tf: TM \rightarrow TN$  is a  $C^r$  vector bundle morphism. Note that  $Tf$  is a monomorphism, epimorphism or equivalence according as  $f$  is an immersion, submersion or diffeomorphism.

If  $TM$  is trivial  $M$  is called *parallelizable*.

There is evidently a category of  $C^r$  vector bundles and  $C^r$  morphisms. An isomorphism in this category is an equivalence of vector bundles. For

each  $C^r$  manifold  $M$  there is the subcategory of  $C^r$  vector bundles over  $M$  and  $C^r$  morphisms over  $I_M$  (for  $r = 0$ ,  $M$  can be any space). An isomorphism in this subcategory is an isomorphism of vector bundles. The tangent functor  $T$  is a covariant functor from the category of  $C^{r+1}$  manifolds to the category of  $C^r$  vector bundles.

The following lemma is the first step in the proof of the covering homotopy theorem.

**1.1. Lemma.** *Let  $\xi = (p, E, B \times I)$  be a  $C^r$  vector bundle,  $0 \leq r \leq \infty$ . Then each  $b \in B$  has a neighborhood  $V \subset B$  such that  $\xi|V \times I$  is trivial.*

*Proof.* By compactness of  $I$  and local triviality of  $\xi$  we can find a neighborhood  $V_i \subset B$  of  $b$  and a subdivision of  $I$  into intervals  $I_i = [t_{i-1}, t_i]$ ,  $0 = t_0 < \dots < t_m = 1$  such that  $\xi$  is trivial over a neighborhood of  $V_i \times [t_{i-1}, t_i]$ ,  $i = 1, \dots, m$ . Put  $V = \bigcap V_i$ ; then  $I_i$  has a neighborhood  $U_i \subset I$  such that  $\xi|V \times U_i$  is trivial.

We proceed by induction on  $m$ ; if  $m = 1$  there is nothing more to prove. Therefore we shall show that if  $m > 1$ , there is a neighborhood  $J \subset I$  of  $[0, t_2]$  such that  $\xi|V \times J$  is trivial. Continuing in this way will eventually show that  $\xi|V \times I$  is trivial. Hence it suffices to assume that  $m = 2$ .

Let  $U_1 = [0, b]$ ,  $U_2 = [a, 1]$ ,  $0 < a < b < 1$ . Choose  $C^r$  trivializations

$$\varphi_i: \xi|(V \times U_i) \rightarrow (V \times U_i) \times \mathbb{R}^n, \quad i = 1, 2.$$

Define a  $C^r$  map

$$\begin{aligned}
 g: V \times [a, b] &\rightarrow GL(n), \\
 g(x) &= \varphi_{1x} \varphi_{2x}^{-1}, \quad x \in V \times [a, b].
 \end{aligned}$$

Next we construct a  $C^r$  map

$$h: V \times [a, 1] \rightarrow GL(n)$$

such that  $h = g$  on  $V \times [a, c]$  for some  $c$ ,  $a < c < b$ . Let  $\lambda: [a, 1] \rightarrow [a, b]$  be a  $C^r$  map which is the identity on a neighborhood  $[a, c]$  of  $a$ .

Put  $\mu = 1_V \times \lambda: V \times [a, 1] \rightarrow V \times [a, b]$ . Define  $h = g \circ \mu$ .

Finally define, for each  $x \in V \times I$ :

$$\psi_x = \begin{cases} \varphi_{1x} & \text{if } x \in V \times [0, c] \\ h(x) \varphi_{2x} \text{ (multiplication in } GL(n)) & \text{if } x \in V \times [a, 1]. \end{cases}$$

The two definitions agree for  $x \in [a, c]$ . Hence the maps  $\psi_x$  fit together to give a  $C^r$  trivialization of  $\xi|V \times I$ .

QED

**1.2. Corollary.** *Every  $C^r$  vector bundle ( $0 \leq r \leq \infty$ ) over an interval is trivial.*

The proof of the covering homotopy theorem is based on the following  $C^r$  version of the homotopy extension property:

**1.3. Lemma.** Fix  $0 \leq r \leq \infty$  and let  $N, P$  be topological spaces which are  $C^r$  manifolds if  $r > 0$ . If  $r = 0$  suppose also that  $N$  is a normal space. Let  $Z \subset N$  be closed and  $V \subset U \subset N$  be open, with  $Z \subset V \subset \mathcal{V} \subset U$ . Suppose given a commuting diagram

$$\begin{array}{ccccc} N \times 0 & \supset & U \times 0 & \subset & U \times I \\ \downarrow f & & & \searrow g & \\ & & & & P \end{array}$$

where  $f$  and  $g$  are  $C^r$ . Then there exists a  $C^r$  map  $h: N \times I \rightarrow P$  such that  $h|_{N \times 0} = f$  and  $h = g$  on  $V \times I$ .

*Proof.* Let  $\lambda: N \rightarrow [0,1]$  be a  $C^r$  map with support in  $U$  such that  $\lambda(V) = 1$ . Define a  $C^r$  map

$$h(x,t) = \begin{cases} g(x, \lambda(x)t) & \text{if } x \in U \\ f(x) & \text{if } x \in N - U. \end{cases}$$

Then  $h$  has the required properties.

QED

The following corollary of Lemma 1.3 is called the *homotopy extension theorem*.

**1.4. Theorem.** Let  $Z$  be a closed subspace of a normal space  $N$ . Let  $f: N \rightarrow P$  be a continuous map and let  $g: Z \times I \rightarrow P$  be a homotopy of  $f|_Z$ . If  $g$  extends to a homotopy of  $f|_U$ , for some neighborhood  $U \subset N$  of  $Z$ , then  $g$  extends to a homotopy  $h: N \times I \rightarrow P$  of  $f$ . In particular this is the case if  $Z$  is a retract of an open subset of  $N$ .

The following theorem is the basic connection between vector bundles and homotopy. For reasons to be explained later it is called the *covering homotopy theorem*.

**1.5. Theorem.** Let  $\xi$  be a  $C^r$  vector bundle over  $B \times I$ ,  $0 \leq r \leq \infty$ . Assume  $B$  is paracompact. Then  $\xi$  is  $C^r$  isomorphic to the vector bundle  $(\xi|_{B \times 0}) \times I$ .

*Proof.* Put  $\xi|_{B \times 0} = \eta = (p, E, B)$ . Let  $\eta \times I = (p \times 1, E \times I, B \times I)$ . We shall construct a bundle map  $\xi \rightarrow \eta \times I$  over the identity map of  $B \times I$ .

For this we use the globalization Theorem 2.2.11 applied to a suitable structure functor on  $B$ .

Let  $\mathcal{X} = \{X_i\}$  be a locally finite closed covering of  $B$  by sets  $X_i$  having the following property: each  $X_i$  has a neighborhood  $V_i \subset B$  such that  $\xi|_{V_i \times I}$  is trivial (use Corollary 1.2). It follows that  $\eta|_{V_i \times I}$  is also trivial. Let  $\mathfrak{Y}$  be the family of unions of elements of  $\mathcal{X}$ .

Let  $Y \in \mathfrak{Y}$ . Consider pairs  $(f, N)$  where  $N \subset B$  is a neighborhood of  $Y$  and  $f: \xi|_N \times I \rightarrow (\eta|_N) \times I$  is a  $C^r$  isomorphism. Two pairs  $(f_i, N_i)$ ,  $i = 0, 1$ , have the same  $Y$ -germ if  $Y$  has a neighborhood  $M \subset N_0 \cap N_1$  such that  $f_0 = f_1$  on  $\xi|_M \times I$ . This is an equivalence relation; an equivalence class is called a  $Y$ -germ. If  $Y \in \mathfrak{Y}$  the set of all  $Y$ -germs is denoted by  $\mathcal{F}(Y)$ .

If  $Z \in \mathfrak{Y}$  and  $Y \subset Z$ , restriction defines a map

$$\mathcal{F}_{YZ}: \mathcal{F}(Z) \rightarrow \mathcal{F}(Y).$$

In this way a structure functor  $(\mathcal{F}, \mathfrak{Y})$  on  $B$  is defined.

It is evident that  $(\mathcal{F}, \mathfrak{Y})$  is continuous; and Lemma 1.1 implies it is non-trivial. In fact Lemma 1.1 also makes  $(\mathcal{F}, \mathfrak{Y})$  locally extendable. For let  $X \in \mathcal{X}$ ,  $Y \in \mathfrak{Y}$ . We must prove that

$$\mathcal{F}_{Y, Y \cup X}: \mathcal{F}(Y \cup X) \rightarrow \mathcal{F}(Y)$$

is surjective. This amounts to extending every  $X \cap Y$ -germ to an  $X$ -germ. Now  $X \times I$  has a neighborhood  $N \times I$  over which both  $\xi$  and  $\eta \times I$  are trivial. Since isomorphisms of the trivial bundle are the same as maps into  $GL(n)$ , local extendability is implied by the following statement: if  $U \subset N$  is a neighborhood of  $X \cap Y$  and

$$g: (U \times I, U \times 0) \rightarrow (GL(n), 1)$$

is a  $C^r$  map (where  $1 \in GL(n)$  is the identity matrix), then there is a neighborhood  $V \subset U$  of  $X \cap Y$  and a  $C^r$  map

$$(N \times I, N \times 0) \rightarrow (GL(n), 1)$$

which agrees with  $g$  on  $V \times I$ . But this is a consequence of Lemma 1.3; therefore  $(\mathcal{F}, \mathfrak{Y})$  is locally extendable.

We now apply Theorem 2.2.11 and conclude that  $\mathcal{F}(B)$  is nonempty. This is equivalent to Theorem 1.5.

QED

**1.6. Corollary.** Two  $C^r$  vector bundles  $\xi_0, \xi_1$  over a paracompact base space  $B$  are  $C^r$  isomorphic if and only if there is a  $C^r$  vector bundle  $\eta$  over  $B \times I$  such that

$$\xi_i \cong \eta|_{B \times i} \quad (i = 0, 1).$$

*Proof.* If  $\eta$  exists,  $\xi_0 \cong \xi_1$  by Theorem 1.5. Conversely, if  $F: \xi_0 \rightarrow \xi_1$  is a  $C^r$  isomorphism we can take  $\eta = \xi_0 \times I$ .

QED



**Exercises**

1. Let  $\xi, \eta$  be vector bundles over a paracompact space and let  $A \subset B$  be closed. Then every morphism  $f: \xi|_A \rightarrow \eta|_A$  over  $1_A$  extends to a morphism  $g: \xi|_W \rightarrow \eta|_W$  over  $1_W$ , for some neighborhood  $W \subset B$  of  $A$ , and if  $f$  is a mono-, epi-, or bimorphism so is  $g$ .
2. Let  $\xi \rightarrow B$  be a vector bundle over a paracompact space, and let  $A \subset B$  be a closed set contractible in  $B$ . Then  $A$  has a neighborhood  $W \subset B$  such that  $\xi|_W$  is trivial.
3. Exercises 1 and 2 are true in the category of  $C^r$  bundles,  $1 \leq r \leq \infty$ .
4. Every Lie group is parallelizable. (A Lie group is a manifold  $G$  together with a group operation  $G \times G \rightarrow G$  which is  $C^\infty$ , and such that inversion  $G \rightarrow G$  is  $C^\infty$ .)

**2. Constructions with Vector Bundles**

In this section we fix a differentiability class  $r$ ,  $0 \leq r \leq \omega$ , and work consistently in the  $C^r$  category. For  $r = 0$  this means we deal with topological spaces and continuous maps, while for  $r > 0$  we deal only with  $C^r$  manifolds,  $C^r$  maps, and  $C^r$  vector bundles. Except for restrictions as indicated below,  $r$  is arbitrary. We write "bundle" for "vector bundle."

There is a general procedure, described in Lang's book [1], which for each functorial construction with vector spaces (direct sum, tensor product, etc.) defines a corresponding construction with vector bundles by applying the original construction to fibres. Rather than proceed at this level of abstraction, we describe explicitly the constructions we shall need.

A *subbundle* of a bundle  $\xi = (p, E, B)$  is a bundle  $\xi_0 = (p_0, E_0, B)$  over the same base space  $B$ , such that  $E_0 \subset E$ ,  $p_0 = p|_{E_0}$ , and there exists a vector bundle atlas  $\Phi$  for  $\xi$  with the following property. There is a linear subspace of  $\mathbb{R}^n$ , which we may take to be  $\mathbb{R}^k$ , such that if  $(\varphi, U) \in \Phi$  then  $\varphi$  maps  $p^{-1}(U) \cap E_0$  into  $U \times \mathbb{R}^k$ , and the pair

$$(\varphi|_{p^{-1}(U) \cap E_0}, U)$$

belongs to the vector bundle structure of  $\xi_0$ .

The notion of subbundle is patterned after the definition of submanifold; and in fact if  $A \subset M$  is a  $C^{r+1}$  submanifold then  $TA$  is a  $C^r$  subbundle of  $TM$ .

If  $\xi_0$  is a subbundle of  $\xi$  then the inclusion map  $E_0 \rightarrow E$  is a monomorphism  $\xi_0 \rightarrow \xi$  over  $1_B$ . Conversely, in analogy with Theorem 1.3.1, if  $\eta$  is a bundle over  $B$  and  $F: \eta \rightarrow \xi$  is a monomorphism over  $1_B$  then  $F(\eta)$ , with the bundle structure induced by  $F$ , is a subbundle of  $\xi$ . It suffices to prove a local result; hence we may suppose  $\xi$  and  $\eta$  are the trivial bundles  $B \times \mathbb{R}^n$  and  $B \times \mathbb{R}^k$ ,  $k \leq n$ . The monomorphism  $F: B \times \mathbb{R}^k \rightarrow B \times \mathbb{R}^n$  has the form

$$F(x, y) = (x, F_x(y))$$

where  $F: B \rightarrow L(\mathbb{R}^k, \mathbb{R}^n)$  is of class  $C^r$ , and each linear map  $F_x: \mathbb{R}^k \rightarrow \mathbb{R}^n$  is injective. Fix  $x \in B$ ; put  $F_x(\mathbb{R}^k) = E \subset \mathbb{R}^n$ . There is no loss of generality in assuming that  $E = \mathbb{R}^k \subset \mathbb{R}^n$  and  $F_x$  is the standard inclusion  $\mathbb{R}^k \rightarrow \mathbb{R}^n$ . Let

$\pi: \mathbb{R}^n \rightarrow \mathbb{R}^k$  be orthogonal projection. There is an open neighborhood  $U \subset B$  of  $x$  such that  $\pi F_z: \mathbb{R}^k \rightarrow \mathbb{R}^k$  is an isomorphism for  $z \in U$ . Let  $K \subset \mathbb{R}^n$  be the kernel of  $\pi$ , so that  $\mathbb{R}^n = \mathbb{R}^k \times K$ . Define

$$\varphi: U \times (\mathbb{R}^k \times K) \rightarrow U \times (\mathbb{R}^k \times K)$$

by

$$\varphi(z, (v, w)) = (z, \pi F_z(v), w).$$

Then  $\varphi$  is a  $C^r$  vector bundle chart for  $\xi$  and  $\varphi$  takes the image of  $F$  into  $U \times \mathbb{R}^k$ . This shows that the image of  $F$  is a subbundle.

Another way of getting subbundles is to take the *kernel* of an epimorphism  $F: \xi \rightarrow \xi'$  which covers  $1_B$ . That is, for each  $x \in B$  let  $\eta_x$  be the kernel of  $F_x: \xi_x \rightarrow \xi'_x$ ; then there is a unique subbundle  $\eta$  of  $\xi$  having fibres  $\eta_x$ . We leave this for the reader to prove.

It is useful to introduce the notion of an *exact sequence* of vector bundles morphisms: this means a finite or infinite sequence

$$\cdots \rightarrow \xi_{i-1} \xrightarrow{F_{i-1}} \xi_i \xrightarrow{F_i} \xi_{i+1} \rightarrow \cdots$$

of morphisms, all covering  $1_B$ , such that for each  $x \in B$  we have

$$\text{image } (F_{i-1})_x = \text{kernel } (F_i)_x$$

for all  $i$ . Of particular interest are the *short exact sequences*

$$0 \rightarrow \xi \xrightarrow{F} \eta \xrightarrow{G} \zeta \rightarrow 0$$

where 0 denotes a 0-dimensional bundle over  $B$ . Such a sequence means merely that  $F$  is a monomorphism,  $G$  is an epimorphism and  $\text{image } F = \text{kernel } G$ .

The existence of kernel subbundles for epimorphism can be stated in functorial language; given the exact sequence

$$\eta \xrightarrow{G} \zeta \rightarrow 0$$

there is an exact sequence

$$(1) \quad 0 \rightarrow \xi \xrightarrow{F} \eta \xrightarrow{G} \zeta \rightarrow 0$$

and (1) is unique in the sense that for any exact sequence

$$0 \rightarrow \xi' \xrightarrow{F'} \eta \xrightarrow{G} \zeta \rightarrow 0$$

there is a unique isomorphism  $\xi \rightarrow \xi'$  such that the diagram

$$\begin{array}{ccccccc} 0 & \rightarrow & \xi & \xrightarrow{F} & \eta & \xrightarrow{G} & \zeta \rightarrow 0 \\ & & \downarrow & & \downarrow & = & \downarrow \\ 0 & \rightarrow & \xi' & \xrightarrow{F'} & \eta & \xrightarrow{G} & \zeta \rightarrow 0 \end{array}$$

commutes.

In the exact sequence (1) we call  $\zeta$  the *quotient bundle* of the monomorphism  $F$ . It is easy to see that every monomorphism has a quotient bundle and the latter is unique up to isomorphism. In particular, if  $\xi \subset \eta$

is a subbundle, the fibres of the quotient bundle are taken to be the vector spaces  $\eta_x/\xi_x$ , and we denote the quotient bundle by  $\eta/\xi$ .

The short exact sequence (1) is said to *split* if there is a monomorphism  $H:\zeta \rightarrow \eta$  such that  $GH = 1_\zeta$ . Working fibrewise we see that this is equivalent to the existence of an epimorphism  $K:\eta \rightarrow \zeta$  such that  $KF = 1_\eta$ .

The *Whitney sum* (or *direct sum*) of bundles  $\xi, \zeta$  over  $B$  is the bundle  $\xi \oplus \zeta$  whose fibre over  $x$  is  $\xi_x \oplus \zeta_x$ . If  $\varphi, \psi$  are charts for  $\xi, \zeta$  respectively over  $U$ , a chart  $\theta$  for  $\xi \oplus \zeta$  over  $U$  is obtained by setting

$$\theta_x = \varphi_x \oplus \psi_x: \xi_x \oplus \zeta_x \rightarrow \mathbb{R}^m \oplus \mathbb{R}^n.$$

The natural exact sequences of vector spaces

$$0 \rightarrow \xi_x \xrightarrow{F_x} \xi_x \oplus \zeta_x \xrightarrow{G_x} \zeta_x \rightarrow 0$$

fit together to give a split exact sequence

$$0 \rightarrow \xi \xrightarrow{F} \xi \oplus \zeta \xrightarrow{G} \zeta \rightarrow 0.$$

Let  $\xi = (p, E, M)$  be a  $C^{r+1}$  vector bundle. Each fibre  $\xi_x$  is a vector space, with origin  $x$ ; hence we identify  $\xi_x$  with  $T_x(\xi_x)$ . Thus  $\xi$  is a subbundle of  $T_M E$  in a natural way. (Note that the "natural" differentiability class of  $T_M E$  is only  $C^r$ .) Since  $M \subset E$  is a submanifold (via the zero section),  $TM$  is a  $C^r$  subbundle of  $T_M E$ . Evidently we have a short exact sequence

$$(2) \quad 0 \rightarrow \xi \rightarrow T_M E \xrightarrow{T_p} TM \rightarrow 0$$

which is split by the tangent map of the zero section:

$$(3) \quad TZ: TM \rightarrow T_M E.$$

This proves:

**2.1. Theorem.** *Let  $\xi = (p, E, M)$  be a  $C^{r+1}$  vector bundle,  $0 \leq r \leq \omega$ . The exact sequence (2) of  $C^r$  vector bundles is naturally split by (3). Thus there is a natural  $C^r$  isomorphism*

$$h_\xi: T_M E \approx \xi \oplus TM.$$

In particular  $\xi \subset T_M E$  as a natural subbundle.

Here *natural* means with respect to  $C^{r+1}$  morphisms. If

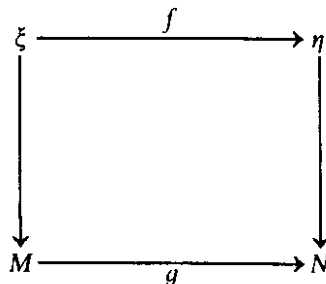

is such a morphism, then the diagram

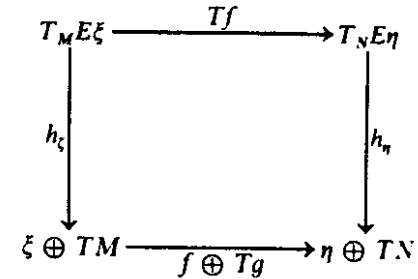

commutes, as is easily checked.

The following simple result is one of the most useful facts about vector bundles.

**2.2. Theorem.** *Every short exact sequence of  $C^r$  vector bundles is split,  $0 \leq r \leq \omega$ , provided the base space is paracompact.*

*Proof.* It suffices to prove that a monomorphism  $F:\xi \rightarrow \eta$  over  $1_B$  has a left inverse. This is true locally because  $F(\xi)$  is a subbundle of  $\eta$ ; we showed above that there are charts for  $\eta$  covering  $B$  taking  $(\eta|U, \xi|U)$  to  $(U \times \mathbb{R}^n, U \times \mathbb{R}^k)$ , and a local left inverse is obtained from a linear retraction  $\mathbb{R}^n \rightarrow \mathbb{R}^k$ . Since local left inverses can be glued together by a partition of unity, the theorem follows.

QED

Let  $\xi = (p, E, B)$  be a vector bundle. An *inner product* or *orthogonal structure* (of class  $C^r$ ) on  $\xi$  is a family  $\alpha = \{\alpha_x\}_{x \in B}$  where each  $\alpha_x$  is an inner product (symmetric, bilinear, positive definite 2-form) on the vector space  $E_x$ , such that the map  $(x, y, z) \mapsto \alpha_x(y, z)$ , defined on  $\{(x, y, z) \in B \times E \times E: x = p(y) = p(z)\}$ , is  $C^r$ . It is easy to construct such an  $\alpha$  whenever  $B$  is paracompact and  $r \leq \omega$ , using partitions of unity. In fact, any  $K$ -germ of an orthogonal structure, where  $K \subset B$  is a closed set, can be extended to an orthogonal structure. The pair  $(\xi, \alpha)$  is called an *orthogonal vector bundle*. If  $M$  is a  $C^{r+1}$  manifold, a  $C^r$  orthogonal structure on  $TM$  is also called a *Riemannian metric* on  $M$  of class  $C^r$ .

Suppose  $(\xi, \alpha)$  is an orthogonal bundle. If  $y, z$  are in the same fibre  $\xi_x$  we write  $\langle y, z \rangle$  or  $\langle y, z \rangle_x$  for  $\alpha_x(y, z)$ . If  $\eta \subset \xi$  is a subbundle, the *orthogonal complement*  $\eta^\perp \subset \xi$  is the subbundle defined fibrewise by

$$(\eta^\perp)_x = (\eta_x)^\perp = \{y \in \xi_x: \langle y, z \rangle = 0, \text{ all } z \in \eta_x\}$$

The natural epimorphism  $\xi \rightarrow \xi/\eta$  maps  $\eta^\perp$  isomorphically onto  $\xi/\eta$ . This provides another method of splitting short exact sequences, one which works just as well for analytic bundles with analytic inner products.

Let  $M \subset N$  be a  $C^{r+1}$  submanifold; suppose  $N$  has a  $C^r$  Riemannian metric. In this case  $TM^\perp \subset T_M N$  is called the *geometric normal bundle* of

$M$  in  $N$ . The algebraic normal bundle of  $M$  in  $N$  is the  $C^\infty$  quotient bundle  $T_M N / TM$ ; it is canonically  $C^\infty$  isomorphic to  $TM^\perp$ .

Let  $\xi = (p, E, M)$  be an orthogonal bundle. In each fibre  $\xi_x$  an orthonormal basis  $e_x$  can be derived from arbitrary basis  $b_x$  of  $\xi_x$  by the Gram-Schmidt orthogonalization method. This classical procedure, which is a deformation retraction of  $GL(n)$  into  $O(n)$ , is so canonical that it leads to a  $C^\infty$  family of orthonormal bases  $\{e_x\}_{x \in U}$ ,  $U \subset M$ , if one starts from an arbitrary  $C^\infty$  family  $\{b_x\}_{x \in U}$ . This shows that  $\xi$  has an orthogonal atlas  $\Phi = \{\varphi_i, U_i\}$ , that is, each map

$$\varphi_{ix}: \xi_x \rightarrow \mathbb{R}^n, \quad x \in U_i$$

is an isometry. It follows that the transition functions

$$g_{ij}: U_i \cap U_j \rightarrow GL(n)$$

take values in  $O(n)$ . In other words every orthogonal bundle has an orthogonal atlas. Conversely, given an orthogonal atlas on  $\xi$  there is a unique orthogonal structure on  $\xi$  making each  $\varphi_{ix}$  isometric.

Two orthogonal vector bundles are *isomorphic* if there is a vector bundle isomorphism between them which preserves inner products.

The following lemma shows that the orthogonal structure on a vector bundle is essentially unique.

**2.3. Lemma.** *Let  $\xi_i = (p_i, E_i, M)$  be a vector bundle,  $i = 0, 1$  and  $f: \xi_0 \rightarrow \xi_1$  an isomorphism. Suppose  $\xi_0$  and  $\xi_1$  have orthogonal structures. Then  $f$  is homotopic through vector bundle maps to an isomorphism of orthogonal bundles.*

*Proof.* Suppose first  $\xi_0$  and  $\xi_1$  are trivial as orthogonal bundles. We have

$$\begin{aligned} f: M \times \mathbb{R}^n &\rightarrow M \times \mathbb{R}^n \\ f(x, y) &= (x, g(x)y), \\ g: M &\rightarrow GL(n). \end{aligned}$$

Since  $O(n)$  is a deformation retract of  $GL(n)$ ,  $g$  is homotopic to  $h: M \rightarrow O(n)$ . Moreover the homotopy can be chosen rel  $g^{-1}O(n)$ . Writing such a homotopy as  $g_t$ ,  $0 \leq t \leq 1$ , with  $g_0 = g$ ,  $g_1 = h$ , we define

$$\begin{aligned} f_t: M \times \mathbb{R}^n &\rightarrow M \times \mathbb{R}^n, \quad 0 \leq t \leq 1 \\ f_t(x, y) &= (x, g_t(x)y). \end{aligned}$$

This is a homotopy of vector bundle isomorphisms from  $f$  to an isomorphism of orthogonal bundles, and  $f_t = f$  whenever  $f$  is already orthogonal.

The general case of Theorem 2.3 is proved by applying this special case successively over each element of a locally finite open cover  $\{U_j\}$  of  $M$  such that  $\xi_0$  and  $\xi_1$  are trivial orthogonal bundles over  $U_j$ .

QED

A quite different construction is that of the induced bundle. Let  $\xi = (p, E, M, \Phi)$  be a vector bundle and  $f: M_0 \rightarrow M$  a map. The induced bundle (or pullback)  $f^*\xi = (p_0, E_0, M_0, \Phi_0)$  is defined as follows. Put

$$E_0 = \{(x, y) \in M_0 \times E : f(x) = p(y)\},$$

and define

$$\begin{aligned} p_0: E_0 &\rightarrow M_0, \\ p_0(x, y) &= x. \end{aligned}$$

Take  $\Phi_0$  to be the maximal ( $C^\infty$ ) atlas containing all charts of the form  $(\psi, f^{-1}U)$  where  $(\varphi, U) \in \Phi$  and if  $z \in f^{-1}(U)$ ,  $f(z) = x \in U$ , then  $\psi_z = \varphi_x$ . The natural vector bundle map  $\Psi: f^*\xi \rightarrow \xi$  over  $f$  is given by  $(x, y) \mapsto y$ .

Let  $q: \eta \rightarrow M_0$  be a vector bundle and  $F: \eta \rightarrow \xi$  a morphism over  $f$ . There is a unique map of total spaces  $H: \eta \rightarrow f^*\xi$  making a commutative diagram

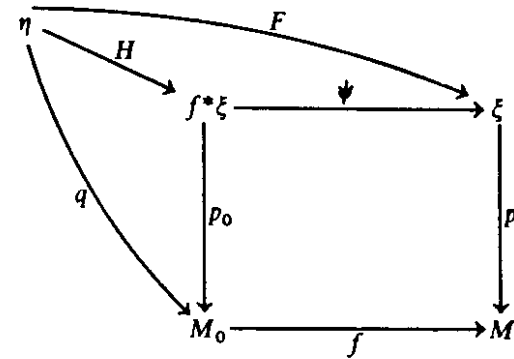

and  $H$  is a morphism of vector bundles. If  $F$  is an epimorphism, monomorphism, or bimorphism, so is  $H$ . This proves the useful fact that if  $F: \eta \rightarrow \xi$  is a vector bundle map over  $f$  then  $\eta$  is canonically isomorphic to the pullback  $f^*\xi$ .

The main theorem about induced bundles is the following corollary of the covering homotopy Theorem 1.5.

**2.4. Theorem.** *Suppose  $B$  is a paracompact space. Let  $f, g: B \rightarrow M$  be homotopic maps, and  $\xi$  a vector bundle over  $M$ . Then  $f^*\xi$  is isomorphic to  $g^*\xi$ . In particular, if  $g$  is constant then  $f^*\xi$  is trivial.*

*Proof.* Let  $H: B \times I \rightarrow M$  be a homotopy from  $f$  to  $g$ . By 1.3,  $H^*\xi$  is isomorphic to  $(H_0^*\xi) \times I = (f^*\xi) \times I$  and also to  $(H_1^*\xi) \times I = (g^*\xi) \times I$ . Looking at these bundles over  $B \times I$  we find that  $f^*\xi$  is isomorphic to  $g^*\xi$ .

QED

**2.5. Corollary.** *Every vector bundle over a contractible paracompact space is trivial.*

The following corollary of 2.5 explains the name “covering homotopy theorem”:

**2.6. Theorem.** *Let  $B_0$  be paracompact. Let  $F: \xi_0 \rightarrow \xi_1$  be a morphism of vector bundles covering  $f: B_0 \rightarrow B_1$ . Let  $h: B_0 \times I \rightarrow B_1$  be a homotopy of  $f$ . Then there is a morphism  $H: \xi_0 \times I \rightarrow \xi_1$  of  $F$  covering  $h$ . If  $F$  is a mono-, epi- or bimorphism,  $H$  has the same property.*

*Proof.* It suffices to find a morphism  $\xi_0 \times I \rightarrow \xi_1 \times I$  which covers the map  $g: B_0 \times I \rightarrow B_1 \times I$ ,  $g(x,t) = (h(x,t), t)$  and which is given by  $F$  over  $B_0 \times 0$ . Using the relation between induced bundles and bundle maps, we see that we may replace  $\xi_1 \times I$  with  $g^*(\xi_1 \times I)$ ,  $g$  with the identity map of  $B_0 \times I$ , and  $B_1 \times I$  with  $B_0 \times I$ . By 1.3  $g^*(\xi_1 \times I)$  can be replaced by a vector bundle  $\eta \times I$  over  $B_0 \times I$ . Thus we are given an isomorphism map  $F: \xi_0 \rightarrow \eta$  and we must extend it to an isomorphism  $H: \xi_0 \times I \rightarrow \eta \times I$ . We can take  $H = F \times 1_I$ . The last statement is obvious.

QED

### Exercises

- Let  $\xi_i = (p_i, E_i, B_i)$  be a  $C^r$  vector bundle,  $i = 0, 1$ , and  $f: B_0 \rightarrow B_1$  a  $C^r$  map,  $0 \leq r \leq \infty$ . There is a  $C^r$  vector bundle  $\eta$  over  $B_0$  whose fibre over  $x$  is  $L(\xi_0, \xi_1)_x$ , such that  $C^r$  sections of  $\eta$  correspond naturally to  $C^r$  morphisms  $\xi_0 \rightarrow \xi_1$  over  $f$ .
- Let  $P^k$  denote real projective  $k$ -space,  $\varepsilon$  the trivial 1-dimensional vector bundle over  $P^k$  and  $\xi$  the normal bundle of  $P^k \subset P^{k+1}$ . Then  $\varepsilon^1 \oplus TP^k \cong \xi \oplus \cdots \oplus \xi$ . [Consider the inclusion  $S^k \subset S^{k+1}$  and the antipodal map.]
- (a) If  $n$  is odd  $TS^n$  has a nonvanishing section and therefore  $TS^n = \varepsilon^1 \oplus \eta$  where  $\varepsilon^k$  is a trivial  $k$ -dimensional bundle. [If  $n = 2m - 1$ ,  $S^n \subset \mathbb{R}^{2m} = C^m$ . If  $x \in S_x^n$  and  $i = \sqrt{-1}$  then  $ix$  is tangent to  $S^m$  at  $x$ .]  
 (b) If  $n = 4m - 1$ ,  $TS^n \cong \varepsilon^3 \oplus \zeta$ . [Use quaternions.]  
 (c) If  $n = 8m - 1$ ,  $TS^n \cong \varepsilon^7 \oplus \lambda$ . [Use Cayley numbers.]
- $TS^n \oplus \varepsilon^1$  is trivial. [Consider  $T(S^n \times \mathbb{R}) \subset T(\mathbb{R}^{n+1})$ . Compare Exercise 12 of Section 1.2.]
- If  $TM$  has a nonvanishing section and  $TM \oplus \varepsilon^1$  and  $TN \oplus \varepsilon^1$  are trivial then  $M \times N$  is parallelizable.
- A product of two or more spheres is parallelizable if they all have positive dimensions and at least one has odd dimension. [Use Exercises 3(a), 4, and 5, and induction.]
- \*7. Find explicit trivialisations of the tangent bundles of  $S^1 \times S^2$ ,  $S^1 \times S^4$ ,  $S^2 \times S^5$ .
- The *frame bundle*  $F(M)$  of an  $n$ -manifold  $M$  is the manifold of dimension  $n^2 + n$  whose elements are the pairs  $(x, \lambda)$  where  $x \in M$  and  $\lambda: \mathbb{R}^n \rightarrow M_x$  is a linear isomorphism. Define  $\pi: F(M) \rightarrow M$  by  $\pi(x, \lambda) = x$ . The topology and differential structure on  $F(M)$  are such that a coordinate system  $(\varphi, U)$  on  $M$  induces a diffeomorphism  $\pi^{-1}(U) \approx U \times GL(n)$  by  $(x, \lambda) \mapsto (x, D\varphi_x \circ \lambda)$ .  
 (a) There is an exact sequence  
 (S)  $0 \rightarrow \text{kernel}(T\pi) \rightarrow TF(M) \rightarrow \pi^*(TM) \rightarrow 0$ .  
 (b)  $\text{kernel}(T\pi)$  and  $\pi^*(TM)$  are trivial vector bundles.  
 (c) Therefore  $F(M)$  is parallelizable.

9. (a) Parts (a) and (b) of Exercise 8 are true even if  $M$  is not paracompact. In this case, however, the exact sequence (S) might not split. A splitting  $j: \pi^*(TM) \rightarrow TF(M)$  of (S) is called a (perhaps nonlinear) *connection* on  $M$ .

(b) Let  $M$  be a connected manifold, not assumed to be paracompact or to have a countable base. If  $M$  has a connection then  $M$  is paracompact and has a countable base. [Hint: use part (a) and Exercise 8(c) to get a Riemannian metric on  $F(M)$ .]

## 3. The Classification of Vector Bundles

We now prove a basic result—ultimately based on transversality—which quickly leads to the classification Theorem 3.4.

**3.1. Theorem.** *Let  $\xi$  be a  $k$ -dimensional  $C^r$  vector bundle over a manifold  $M$ ,  $0 \leq r \leq \infty$ . Let  $U \subset M$  be a neighborhood of a closed set  $A \subset M$ . Suppose that*

$$F: \xi|_U \rightarrow U \times \mathbb{R}^s$$

*is a  $C^r$  monomorphism (of vector bundles) over  $1_U$ . If  $s \geq k + \dim M$  then there is a  $C^r$  monomorphism  $\xi \rightarrow M \times \mathbb{R}^s$  over  $1_M$  which agrees with  $F$  over some neighborhood of  $A$  in  $U$ .*

*Proof.* Consider first the special case where  $\xi$  is trivial. Then for each  $x \in U$ ,  $F|_{\xi_x}$  is a linear map  $g(x): \mathbb{R}^k \rightarrow \mathbb{R}^s$  of rank  $k$ . We thus obtain a map  $g: U \rightarrow V_{s,k}$ , which is easily proved to be  $C^r$ . Since  $\dim M \leq s - k$  we can apply Theorem 3.2.5 (on extending continuous maps into  $V_{n,k}$ ) to find a  $C^r$  map  $h: M \rightarrow V_{s,k}$  which extends the  $A$ -germ of  $g$ . If  $r > 0$  we use the relative approximation Theorem 2.2.5 to make  $h$   $C^r$ . Then we interpret  $h$  as a monomorphism  $M \times \mathbb{R}^k \rightarrow M \times \mathbb{R}^s$  over  $1_M$ .

The general case follows by using the globalization Theorem 2.2.11.

(For those who want more details: a structure functor  $(\mathcal{F}, \mathfrak{Y})$  on  $M$  is defined as follows. Let  $\mathcal{X} = \{X_i\}$  be a locally finite closed cover of  $M$  such that  $\xi$  is trivial over a neighborhood of each  $Y_i$ . Let  $\mathfrak{Y}$  be the family of all unions of elements of  $\mathcal{X}$ . For  $Y \in \mathfrak{Y}$  let  $\mathcal{F}(Y)$  be the set of equivalence classes  $[\varphi]_Y$  (“ $Y$ -germs”) of maps  $\varphi: \xi|_W \rightarrow W \times \mathbb{R}^s$ , as follows.  $W \subset M$  can be any neighborhood of  $Y$ , and  $\varphi$  must be a monomorphism over  $1_W$  which agrees with  $f$  over some neighborhood of  $Y \cap A$ . The equivalence relation is:  $[\varphi]_Y = [\psi]_Y$  if  $\varphi$  and  $\psi$  agree over some neighborhood of  $Y$ . Restriction makes  $(\mathcal{F}, \mathfrak{Y})$  into a structure functor which is clearly continuous and non-trivial; and we proved above that  $(\mathcal{F}, \mathfrak{Y})$  is locally extendable. Therefore Theorem 2.2.11 yields Theorem 3.1.)

QED

Let  $\gamma_{s,k} \rightarrow G_{s,k}$  be the following vector bundle over the Grassmannian  $G_{s,k}$ : the fibre of  $\gamma_{s,k}$  over the  $k$ -plane  $P \subset \mathbb{R}^s$  is the set of pairs  $(P, x)$  where  $x \in P$ . This makes  $\gamma_{s,k}$  into an analytic  $k$ -dimensional vector bundle in a natural way. We call this the *Grassmann bundle* or sometimes the *universal bundle* over  $G_{s,k}$ .

From Theorem 3.1 we have:

**3.2. Corollary.** Let  $\eta$  be a  $C^r$   $k$ -plane bundle over  $V \times I$  where  $V$  is an  $n$ -manifold. Suppose that  $F_i: \eta|V \times i \rightarrow \mathbb{R}^s$  is a  $C^r$  monomorphism for  $i = 0, 1$ . If  $s > k + n$  then  $F_0$  and  $F_1$  extend to a  $C^r$  monomorphism  $F: \eta \rightarrow \mathbb{R}^s$ .

*Proof.* By the covering homotopy theorem,  $F_0$  and  $F_1$  extend to a monomorphism  $\eta|U \rightarrow \mathbb{R}^s$ , where  $U \subset V \times I$  is a neighborhood of  $V \times \{0,1\}$ . Now apply 3.1 (with  $M = V \times I$ ,  $A = V \times \{0,1\}$ , etc.)

QED

Another corollary of Theorem 3.1 is the existence of “inverse” bundles:

**3.3 Theorem.** Let  $\xi$  be a  $C^r$   $k$ -plane bundle over an  $n$ -manifold  $M$ ,  $0 \leq r \leq \infty$ . Then there is a  $C^r$   $n$ -plane bundle  $\eta$  over  $M$  such that  $\xi \oplus \eta \cong M \times \mathbb{R}^{n+k}$ .

*Proof.* Let  $F: \xi \rightarrow M \times \mathbb{R}^{n+k}$  be a monomorphism over  $1_M$ . Give the trivial bundle  $M \times \mathbb{R}^{n+k}$  its standard orthogonal structure, and for  $\eta$  take subbundle  $F(\xi)^\perp \subset M \times \mathbb{R}^{n+k}$ .

QED

We now give another meaning to a  $C^r$  monomorphism  $F: \xi \rightarrow M \times \mathbb{R}^s$  over  $1_M$ . Define a vector bundle map

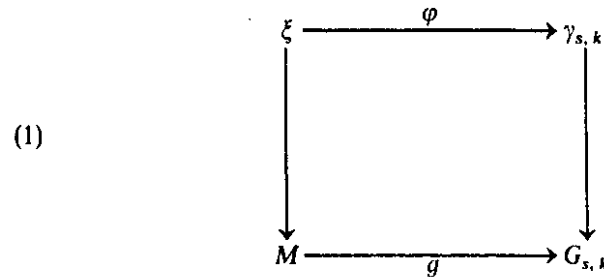

as follows. To  $y \in M$ ,  $g$  assigns the  $k$ -plane  $g(y) = F(\xi_y) \in G_{s,k}$ . If  $z \in \xi_y$  defines  $\varphi(z) = (F(\xi_y), f(z))$ . It is easy to see that this correspondence  $F \mapsto (\varphi, g)$  induces a natural bijection between  $C^r$  monomorphisms  $\xi \rightarrow M \times \mathbb{R}^s$  over  $1_M$ , and  $C^r$  bundle maps  $\xi \rightarrow \gamma_{s,k}$ .

The map  $g: M \rightarrow G_{s,k}$  in diagram (1) has the property that  $g^*\gamma_{s,k} \cong \xi$ . Such a map is called a *classifying map* for  $\xi$ ; we also say  $g$  *classifies*  $\xi$ . From Theorems 3.1 and 3.2 and a collar on  $\partial M$  (see Section 4.6), we obtain the following *classification theorem*:

**3.4. Theorem.** If  $s \geq k + n$  then every  $C^r$   $k$ -plane bundle  $\xi$  over an  $n$ -manifold  $M$  has a classifying map  $f_\xi: M \rightarrow G_{s,k}$ . In fact any classifying map  $\partial M \rightarrow G_{s,k}$  for  $\xi|_{\partial M}$  extends to a classifying map for  $\xi$ . When  $s > k + n$  the homotopy class of  $f_\xi$  is unique, and if  $\eta$  is another  $k$ -plane bundle over  $M$  then  $f_\xi \simeq f_\eta$  if and only if  $\xi \cong \eta$ .

*Proof.* The only statement needing further proof is the “if” clause. Suppose  $\psi: \eta \cong \xi$  and let  $\varphi: \xi \rightarrow \gamma_{s,k}$  be a bimorphism covering  $f_\xi$ . From

the diagram

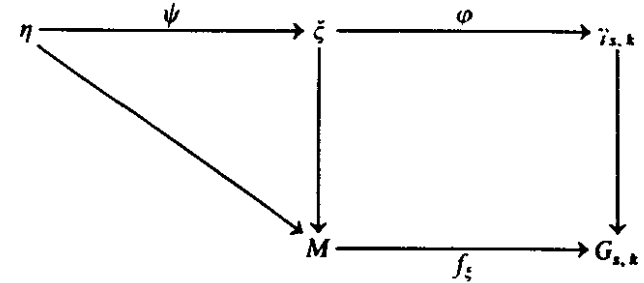

we see that  $f_\xi$  classifies both  $\xi$  and  $\eta$ . Since the classifying map  $f_\eta$  is unique up to homotopy when  $s > k + n$  it follows that  $f_\xi \simeq f_\eta$ .

QED

Taken together with the covering homotopy theorem, this result is of fundamental importance because it converts the theory of vector bundles into a branch of homotopy theory. To put it another way, we can use whatever we know about maps to study vector bundles. For example, approximation theory yields:

**3.5. Theorem.** Every  $C^x$  vector bundle  $\xi$  over a  $C^x$  manifold  $M$  has a compatible  $C^\infty$  bundle structure; and such a structure is unique up to  $C^x$  isomorphism.

*Proof.* Let  $g: M \rightarrow G_{s,k}$  be a  $C^r$  classifying map for  $\xi$ . Then  $g$  can be approximated by, and so is homotopic to, a  $C^\infty$  map  $h$ . Therefore

$$\xi \cong g^*\gamma_{s,k} \cong h^*\gamma_{s,k}.$$

But  $h^*\gamma_{s,k}$  is a  $C^\infty$  bundle. Thus  $\xi$  has a  $C^\infty$  structure.

If  $\eta_0$  and  $\eta_1$  are  $C^\infty$  bundles that are  $C^r$  isomorphic, they have  $C^x$  classifying maps that are homotopic. These maps are then  $C^\infty$  homotopic. Pulling back  $\gamma_{s,k}$  over  $M \times I$  by such a homotopy gives a  $C^\infty$  vector bundle  $\xi$  such that

$$\xi|_{M \times i} \cong_\infty \eta_i, \quad i = 0.$$

Therefore  $\eta_0 \cong_\infty \eta_1$  by Theorem 1.4.

QED

The same result is true if  $C^\infty$  is replaced by  $C^\omega$ ; the proof uses the analytic approximation Theorem 2.5.1. See also Exercise 3 of Section 4.7 for a theorem of this type that can be proved without using Theorem 2.5.1.

From now on we need not specify the differentiability class of a vector bundle.

Although the theorems of this section have been stated for manifolds, they are also true (ignoring differentiability) for vector bundles over simplicial (or CW) complexes of finite dimension. The proofs are almost the same. The main difference is that Theorem 3.1 is proved by induction on dimension;

the inductive step is proved by extending a map  $\partial \Delta^m \rightarrow V_{s,k}$  to  $\Delta^m$  if  $m \leq s - k$ , where  $\Delta^m$  is an  $m$ -simplex. Similarly for CW complexes.

The classification of vector bundles over more general spaces can be stated as follows. Let  $K^k(X)$  denote the set of isomorphism classes of  $k$ -plane bundles over the space  $X$ . Let  $[X, G_{s,k}]$  be the set of homotopy classes of maps from  $X$  to  $G_{s,k}$ . A natural map

$$\Theta_X: K^k(X) \rightarrow [X, G_{s,k}]$$

is induced by the correspondence  $f \mapsto f^* \gamma_{s,k}$ ; that  $\Theta_X$  is well defined follows from the covering homotopy theorem, if we assume  $X$  paracompact. Then one can prove: if  $X$  has the homotopy type of a simplicial or CW complex of dimension less than  $s - k$ , the map  $\Theta_X$  is bijective.

**Exercises**

[ $X$  denotes either a manifold, or a finite dimensional simplicial or CW complex;  $\varepsilon^k$  denotes the trivial  $k$ -plane bundle.]

1. (a) Let  $i: G_{s,k} \rightarrow G_{s+1,k+1}$  be the natural inclusion. Then

$$i^* \gamma_{s+1,k+1} \cong \gamma_{s,k} \oplus \varepsilon^1.$$

(b) If  $\dim X < s - k$ , then under the classification of vector bundles the map

$$i_*: [X, G_{s,k}] \rightarrow [X, G_{s+1,k+1}]$$

corresponds to the map

$$\sigma: K^k X \rightarrow K^{k+1} X, \quad [\xi] \mapsto [\xi \oplus \varepsilon].$$

2. Suppose  $\dim X < \min \{s - k, r - j\}$ . The natural embedding

$$G_{s,k} \times G_{r,j} \rightarrow G_{s+r,k+j}$$

induces the map

$$K^k X \times K^j X \rightarrow K^{k+j} X$$

which corresponds to Whitney sum.

3. The map  $\sigma: K^k X \rightarrow K^{k+1} X$  (see Exercise 1) is surjective if  $\dim X \leq k$  and injective if  $\dim X < k$ . [Use Exercise 7a and Exercise 9, Section 3.2.]

4. Let  $\xi, \eta, \zeta$  be bundles over  $X$  such that  $\xi \oplus \eta \cong \xi \oplus \zeta$ . If  $\dim \xi > \dim X$  then  $\eta \cong \zeta$ . [Suppose  $\eta \oplus \alpha$  is trivial; use Exercise 3.]

5. Let  $G_{s,k} \rightarrow G_{s+1,k}$  be the natural inclusion and put  $G_{\infty,k} = \bigcup_{s=k}^{\infty} G_{s,k}$ . Then  $K^k X$  is naturally isomorphic to  $[X, G_{\infty,k}]$ . (More usually  $G_{\infty,k}$  is denoted by or  $BO(k)$ . It is called the classifying space for the functor  $K^k$ , and also for the group  $O(k)$ .)

6. Two vector bundles  $\xi, \eta$  over  $X$  are stably isomorphic if  $\xi \oplus \varepsilon^j \cong \eta \oplus \varepsilon^k$  for some  $j, k$ . Let  $KX$  denote the set of stable isomorphism classes of bundles over  $X$ . The operation of Whitney sum induces a natural abelian group structure on  $KX$ .

\*7. There are maps  $G_{\infty,k} \rightarrow G_{\infty,k+1}$  whose direct limit  $G_{\infty,\infty}$  is a classifying space for the functor  $K$  of Exercise 6. That is, there is a natural isomorphism (of sets)  $KX \approx [X, G_{\infty,\infty}]$ . Moreover, there is a map  $G_{\infty,\infty} \times G_{\infty,\infty} \rightarrow G_{\infty,\infty}$  such that the resulting binary operation on  $[X, G_{\infty,\infty}]$  corresponds to the Whitney sum operation in  $KX$ . (More usually  $G_{\infty,\infty}$  is denoted by  $BO$ .)

8. A  $k$ -plane bundle over  $S^n$  has a vector bundle atlas containing only two charts, each of whose domains contain a hemisphere. The transition function for such a pair of charts restricts to a map of the equator  $S^{n-1}$  into  $GL(k)$ . In this way an isomorphism  $K^k(S^n) \approx \pi_{k-1}(GL(k)) \approx \pi_{k-1}(O(k))$  is established, with no restriction on  $k, n$ .

9. Let  $\xi \rightarrow S^n$  be a  $k$ -plane bundle corresponding to  $\alpha \in \pi_{n-1}(GL(k))$  (see Exercise 8). If  $\eta \rightarrow S^n$  corresponds to the inverse of  $\alpha$  (in the abelian group  $\pi_{n-1}(GL(k))$ ) then  $\xi \oplus \eta$  is trivial. One can interpret  $\eta$  as the "reflection" of  $\xi$  in the equator.

\*10. Every vector bundle over  $S^3$  is trivial. [Hint: it suffices to consider 3-plane bundles.]

**4. Oriented Vector Bundles**

Let  $V$  be a (real) finite dimensional vector space of dimension  $n > 0$ . Two bases  $(e_1, \dots, e_n), (f_1, \dots, f_n)$  of  $V$  are equivalent if the automorphism  $A: V \rightarrow V$  such that  $Ae_i = f_i$  has positive determinant. An orientation of  $V$  is an equivalence class  $[e_1, \dots, e_n]$  of bases. If  $\dim V > 0$  there are just two orientations. If one of them is denoted by  $\omega$ , then  $-\omega$  denotes the other one.

If  $L: V \rightarrow W$  is an isomorphism of vector spaces and  $\omega = [e_1, \dots, e_n]$  is an orientation of  $V$  then  $L(\omega) = [Le_1, \dots, Le_n]$  is the induced orientation of  $W$ .

If  $\dim V = 0$  an orientation of  $V$  simply means one of the numbers  $\pm 1$ . Many special but trivial arguments for this case will be omitted.

An oriented vector space is a pair  $(V, \omega)$  where  $\omega$  is an orientation of  $V$ . Given  $(V, \omega)$  and  $(V', \omega')$  an isomorphism  $L: V \rightarrow V'$  is called orientation preserving if  $L(\omega) = \omega'$ ; otherwise  $L$  is orientation reversing.

The standard orientation  $\omega^n$  of  $\mathbb{R}^n, n > 0$ , is  $[e_1, \dots, e_n]$  where  $e_i$  is the  $i$ 'th unit vector. The standard orientation of  $\mathbb{R}^0$  is  $+1$ .

Let  $0 \rightarrow E' \xrightarrow{\varphi} E \xrightarrow{\psi} E'' \rightarrow 0$  be an exact sequence of vector spaces. Given orientations  $\omega' = [e_1, \dots, e_m]$  of  $E'$  and  $\omega'' = [f_1, \dots, f_n]$  of  $E''$ , an orientation  $\omega$  of  $E$  is defined by

$$\omega = [\varphi e_1, \dots, \varphi e_m, g_1, \dots, g_n] \quad \text{where} \quad \psi g_i = f_i,$$

independent of the choice of the  $g_i$ . For if also  $\psi h_i = f_i$ , the automorphism  $A: E \rightarrow E$  such that  $Ae_j = e_j$  and  $Ag_i = h_i$  fits into the commutative diagram

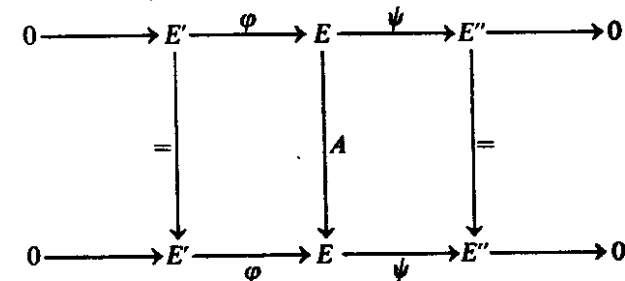

which implies that  $\det A = 1$ . Hence

$$[\varphi e_1, \dots, \varphi e_m, g_1, \dots, g_n] = [\varphi e_1, \dots, \varphi e_m, h_1, \dots, h_n].$$

It is easy to see that any two of  $\omega', \omega, \omega''$  determine the third uniquely. We write  $\omega = \omega' \oplus \omega'', \omega' = \omega/\omega'', \omega'' = \omega/\omega'$ .

Now let  $\xi = (p, E, B)$  be a vector bundle. An *orientation* for  $\xi$  is a family  $\omega = \{\omega_x\}_{x \in B}$  where  $\omega_x$  is an orientation of the fibre  $E_x$  such that  $\xi$  has an atlas  $\Phi$  with the following property: if  $\varphi: \xi|U \rightarrow \mathbb{R}^n$  is in  $\Phi$  then

$$\varphi_x: (E_x, \omega_x) \rightarrow (\mathbb{R}^n, \omega^n)$$

is orientation preserving. We call  $\omega$  a *coherent* family of orientations of the fibres. The atlas  $\Phi$  is an *oriented atlas* belonging to  $\omega$ .

If  $\xi$  has an orientation  $\omega$ , then  $\xi$  is called *orientable* and the pair  $(\xi, \omega)$  is an *oriented vector bundle*. It is easy to see that if  $\xi$  is a  $C^r$  vector bundle for any  $r \geq 1$ , and  $\omega$  is an orientation, then  $\xi$  has a  $C^r$  atlas which belongs to  $\omega$ . An oriented  $C^r$  vector bundle can be defined as a  $C^r$  vector bundle together with a maximal  $C^r$  oriented atlas.

Let  $F: \eta \rightarrow \xi$  be a bimorphism. If  $\xi$  has an orientation  $\omega$ , there is a unique orientation  $\theta$  of  $\eta$  such that  $F$  maps fibres to fibres preserving orientation. It follows that the pullback  $f^*\xi$  of an oriented bundle  $(\xi, \omega)$  has a natural orientation  $f^*\omega$ .

Let  $\xi = (p, E, B)$  be any vector bundle. Let  $\lambda: I \rightarrow B$  be a path and  $\omega$  an orientation of  $\xi|_{\lambda(0)}$ . We propagate  $\omega$  along  $\lambda$  as follows. Since the induced bundle  $\lambda^*\xi \rightarrow I$  is trivial and  $I$  is connected, there is a unique orientation  $\theta$  of  $\lambda^*\xi$  such that over  $0 \in I$ ,  $\theta$  coincides with  $\lambda^*\omega$ . Denote by  $\lambda_*\omega$  the orientation of  $\xi|_{\lambda(1)}$  such that over  $1 \in I$ ,  $\lambda^*(\lambda_*\omega)$  coincides with  $\theta$ .

Let  $\mu: I \rightarrow B$  be another path with  $\lambda(0) = \mu(0)$  and  $\lambda(1) = \mu(1)$ . If  $\lambda \simeq \mu$  rel  $\{0, 1\}$ , then  $\mu_*\omega = \lambda_*\omega$ . To see this, let  $f: D^2 \rightarrow B$  be such that  $f = \lambda$  on the top semicircle  $I_+ \subset \partial D^2$ , and  $f = \mu$  on the bottom semicircle  $I_- \subset \partial D^2$ . Since  $D^2$  is contractible,  $f^*\xi$  is trivial and therefore orientable. Since  $D^2$  is connected,  $f^*\xi$  has a unique orientation  $\theta$  containing  $f^*\omega = \lambda^*\omega = \mu^*\omega$ . Over  $1 \in I$ , therefore, the orientations  $\theta, f^*\lambda_*\omega$  and  $f^*\mu_*\omega$  all coincide. This implies that  $\lambda_*\omega = \mu_*\omega$ .

It follows that every vector bundle over a simply connected manifold  $M$  is orientable. To see this, pick a point  $x_0 \in M$  and for each  $y \in M$  let  $\lambda_y: I \rightarrow M$  be a path joining  $x_0$  to  $y$  (we may assume  $M$  path connected). Let  $\omega$  be an arbitrary orientation of  $\xi|_{x_0}$  and define  $\omega_y = \lambda_{y*}\omega$ . Since  $M$  is simply connected,  $\omega_y$  is independent of the choice of  $\lambda_y$ . Let  $U \subset M$  be a connected coordinate domain. Fix  $y \in U$ . For  $z \in U$  we can take  $\lambda_z$  to be  $\lambda_y$  followed by a path in  $U$  from  $y$  to  $z$ . This choice of the  $\lambda_z$  shows that the resulting family of orientations  $\{\omega_z\}_{z \in U}$  is an orientation of  $\xi|U$ . It follows that  $\omega = \{\omega_y\}_{y \in M}$  is an orientation of  $\xi$ .

More generally, the vector bundle  $\xi \rightarrow M$  is orientable if and only if every loop  $\lambda: I \rightarrow M$ ,  $\lambda(0) = \lambda(1)$ , preserves orientation of  $\xi|_{\lambda(0)}$ ; that is,  $\lambda_*\omega = \omega$  if  $\omega$  is an orientation of  $\xi|_{\lambda(0)}$ . If this condition is satisfied and  $M$  is connected, then a given orientation of a single fibre  $\xi_x$  extends to a unique orientation of  $\xi$  by propagation along paths. Since each fibre has exactly two orientations, we see that an *orientable vector bundle over a connected*

manifold has just two orientations. If one of these is called  $\omega$ , the other is called  $-\omega$ .

In general every vector bundle  $\xi = (p, E, B)$  has an oriented double covering  $\tilde{\xi} = (\tilde{p}, \tilde{E}, \tilde{B})$ . Let

$$\tilde{B} = \{(x, \omega) : x \in B, \omega \text{ is an orientation of } \xi_x\}.$$

The topology of  $\tilde{B}$  is generated by the subsets  $\{x, \theta_x\}_{x \in U}$  where  $U \subset B$  is open,  $\xi|U$  is orientable, and  $\theta$  is an orientation of  $\xi|U$ . There is a natural map  $p: \tilde{B} \rightarrow B$ ,  $p(x, \omega) = x$ . Define  $\tilde{\xi} = p^*\xi$ . The *natural orientation* of  $\tilde{\xi}$  is defined as follows: given  $(x, \omega) \in \tilde{B}$ , assign to  $\tilde{\xi}|(x, \omega)$  the orientation  $p^*\omega$ . A section  $B \rightarrow \tilde{B}$  is the same as an orientation of  $\xi$ . Therefore  $\tilde{\xi}$  is orientable if  $B$  is simply connected.

Let  $0 \rightarrow \xi' \rightarrow \xi \rightarrow \xi'' \rightarrow 0$  be a short exact sequence of vector bundles. Given orientations  $\omega', \omega''$  for  $\xi', \xi''$  respectively, a family  $\omega = \{\omega_x\}_{x \in B}$  of orientations of fibres of  $\xi$  is obtained by setting  $\omega_x = \omega'_x \oplus \omega''_x$ . Local trivializations make it clear that  $\omega$  is coherent; thus  $\omega$  is an orientation of  $\xi$ . Any two of  $\omega, \omega', \omega''$  determine the third. We put  $\omega = \omega' \oplus \omega''$ , etc. In particular we have

**4.1. Lemma.** *Two of  $\xi, \xi', \xi''$  are orientable if and only if the third is.*

Let  $M$  be a manifold.  $M$  is called *orientable* if  $TM$  is an orientable vector bundle. An *orientation* of  $M$  means an orientation of  $TM$ ; an *oriented manifold* is a pair  $(M, \omega)$  where  $\omega$  is an orientation of  $M$ . We define  $-\omega$  to be the orientation of  $M$  such that  $(-\omega)_x = -\omega_x$  (these are orientations of  $M_x$ ) for all  $x \in M$ . If  $M$  is connected and orientable then it has exactly two orientations,  $\omega$  and  $-\omega$ . Every simply connected manifold is orientable.

An alternative definition of "orientable manifold" is:  $M$  is orientable if it has an atlas whose coordinate changes have positive Jacobian determinants at all points. A maximal atlas of this kind is an *oriented differential structure*. By considering natural vector bundle charts it is easy to see that the two definitions are equivalent.

Let  $(M, \omega)$  and  $(N, \theta)$  be oriented manifolds. A diffeomorphism  $f: M \approx N$  is called *orientation preserving* if  $Tf: (TM, \omega) \rightarrow (TN, \theta)$  preserves orientation; in this case we write  $f(\omega) = \theta$ . On the other hand  $f$  is called *orientation reversing* if  $Tf$  reverses orientation. Notice that when  $M$  is connected,  $f$  must have one of these properties; to determine which one, it suffices to see whether a single  $T_x f$  preserves orientation.

Now let  $M$  be a connected orientable manifold and let  $g: M \approx M$  be a diffeomorphism. Let  $\omega, -\omega$  be the two orientations of  $M$ . Then either  $g(\omega) = \omega$  and  $g(-\omega) = -\omega$ , or else  $g(\omega) = -\omega$  and  $g(-\omega) = \omega$ . In other words  $g$  either preserves both orientations or reverses both orientations. We call  $g$  orientation preserving or orientation reversing, accordingly, independent of any choice of orientation for  $M$ . If  $\Phi$  is an oriented differential structure for  $M$  then  $f$  preserves orientation if  $f^*\Phi = \Phi$ , that is, if the derivative of  $f$  at any point, expressed by charts in  $\Phi$ , has positive Jacobian.

As an example consider a diffeomorphism of  $S^n$  obtained from an orthogonal linear operator  $L \in O(n + 1)$ . Since  $L$  also maps  $D^{n+1}$  onto itself,  $L|S^n$  is orientation-preserving exactly when  $L|D^{n+1}$  is orientation-preserving, or equivalently, when  $L$  preserves orientation of  $\mathbb{R}^{n+1}$ . Thus  $L|S^n$  preserves orientation if and only if  $\det L > 0$ . In particular, reflection in a hyperplane always reverses orientation; the antipodal map of  $S^n$  preserves orientation if  $n$  is odd and reverses orientation if  $n$  is even.

Let  $M$  be a manifold and  $\xi = (\tilde{p}, \tilde{E}, \tilde{M})$  the oriented double covering of the vector bundle  $TM$ . It is easy to see that  $\xi$  is naturally isomorphic to  $T\tilde{M}$ . Therefore  $\tilde{M}$  is an orientable manifold. This shows that every manifold  $M$  has an oriented double covering  $\tilde{M}$ . It is easy to see that the natural map  $p: \tilde{M} \rightarrow M$  is a submersion. If  $M$  is orientable, then each orientation  $\omega$  of  $M$  defines a section  $s_\omega: M \rightarrow \tilde{M}$  by  $s_\omega(x) = (x, \omega_x)$ . Conversely, every section defines an orientation of  $M$ .

Next consider the algebraic normal bundle  $\nu$  of  $\partial M$  in  $M$ :

**4.2. Theorem.**  $\nu$  is trivial, and hence orientable.

*Proof.* Let  $n = \dim M$ . Put

$$\mathbb{R}_+^n = \{x \in \mathbb{R}^n : x_1 \geq 0\}.$$

Let  $\pi: \mathbb{R}^n \rightarrow \mathbb{R}$  be the projection  $\pi(x) = x_1$ .

Let  $\{\varphi_i: U_i \rightarrow \mathbb{R}_+^n\}$  be family of charts of  $M$  that cover  $\partial M$ .

Define morphisms

$$F_i: TM|_{\partial U_i} \rightarrow \mathbb{R},$$

$$F_{ix} = D(\pi\varphi_i)_x.$$

Since  $F_i$  maps  $T(\partial U_i)$  to 0, it induces a morphism

$$G_i: \nu|_{\partial U_i} \rightarrow \mathbb{R}$$

which is clearly a bimorphism. Note especially that if  $x \in \partial U_i \cap \partial U_j$ , the linear map

$$G_{jx}G_{ix}^{-1}: \mathbb{R} \rightarrow \mathbb{R}$$

is positive. This is equivalent to the fact that each  $\varphi_i$  maps  $U_i$  onto the same side of  $\partial\mathbb{R}_+^n$  in  $\mathbb{R}^n$ . This already proves  $\nu$  orientable. A trivialization of  $\nu$  is obtained by gluing together the  $G_i$  with a partition of unity.

QED

Implicit in the last part of the above proof is this result:

**4.3. Theorem.** An orientable 1-dimensional vector bundle over a paracompact space is trivial.

This is true in all  $C^\infty$  categories; as usual the analytic case requires a separate proof. But Theorem 4.3 is false without paracompactness: the tangent bundle of the long line is orientable, but if it were trivial the long line would have a Riemannian metric and thus would be metrizable!

We now give some classical geometric applications of orientations.

**4.4. Lemma.** Let  $N$  be a connected manifold and let  $M \subset N$  be a connected closed submanifold of codimension 1,  $\partial M = \partial N = \emptyset$ . If  $M$  separates  $N$  then the normal bundle  $\nu$  of  $M$  in  $N$  is trivial, and  $N - M$  has exactly two components; and the (topological) boundary of each component is  $M$ .

*Proof.* Let  $A \subset N$  be a component of  $N - M$ . Then  $M$  is the boundary of the subset  $A$ . For, since  $M$  is closed,  $\text{Bd } A$  is a nonempty closed subset of  $M$ . Looking at submanifold charts for  $(N, M)$  one sees that  $\text{Bd } A$  is also open in  $M$ . Since  $M$  is connected,  $\text{Bd } A = M$ . Such charts also show that  $\bar{A}$  is a submanifold of  $N$  with  $\partial\bar{A} = M$ . Clearly  $\nu$  is also the normal bundle of  $M$  in  $\bar{A}$ ; therefore Theorem 4.2 implies that  $\nu$  is trivial. Let  $B$  be another component of  $N - M$ ; then  $\bar{B}$  is also a submanifold of  $N$  with boundary  $M$ . Thus  $\bar{A} \cup \bar{B}$  is a closed subset of  $N$ . Invariance of domain (or the inverse function theorem) show that  $\bar{A} \cup \bar{B}$  is also open. Therefore  $\bar{A} \cup \bar{B} = N$ .

QED

From Lemmas 4.1 and 4.4 we obtain:

**4.5. Theorem.** Let  $N$  be a connected manifold and  $M \subset N$  a closed connected submanifold of codimension 1,  $\partial M = \partial N = \emptyset$ . If  $M$  separates  $N$  then  $M$  is orientable if  $N$  is orientable.

Next, a basic topological result:

**4.6. Theorem.** Let  $N$  be a simply connected manifold and  $M \subset N$  a connected closed submanifold of codimension 1,  $\partial M = \partial N = \emptyset$ . Then  $M$  separates  $N$ .

*Proof.* We may suppose  $N$  connected. Let  $x_0, x_1 \in N - M$ . Let  $f: I \rightarrow N$  be a  $C^\infty$  path from  $x_0 = f(0)$  to  $x_1 = f(1)$ ; assume  $f$  is transverse to  $M$ . Then  $f^{-1}(M)$  is a finite subset of  $I$ . Let  $L(x_0, x_1, f) \in \mathbb{Z}_2$  be the reduction mod 2 of the cardinality of  $f^{-1}(M)$ . We assert that  $L(x_0, x_1, f)$  is independent of  $f$ . For let  $g: I \rightarrow M$  be another such path. Since  $N$  is simply connected, the paths  $f, g$  are homotopic rel end points. Thus there is a map  $H: I \times I \rightarrow N$  such that  $H(t, 0) = f(t)$ ,  $H(t, 1) = g(t)$ ,  $H(0, t) = x_0$ , and  $H(1, t) = x_1$ . By approximation we may assume that  $H$  is  $C^\infty$  and transverse to  $M$ . Then  $H^{-1}(M)$  is a compact 1-dimensional submanifold of  $I \times I \subset \mathbb{R}^2$  with boundary  $f^{-1}(0) \times 0 \cup g^{-1}(0) \times 1$ . Since  $H^{-1}(M)$  has an even number of boundary points, the assertion follows.

It is clear that there exist  $x_0, x_1, f$  as above with  $L(x_0, x_1, f) = 1$ ; for example, take  $x_0$  and  $x_1$  on opposite sides of  $M$ , in a small arc transverse to  $M$ . Then  $x_0$  and  $x_1$  must be in different components of  $N - M$ , since otherwise there would exist a path  $g$  joining them in  $N - M$ . Such a path can be made  $C^\infty$  and transverse to  $N$ ; then  $L(x_0, x_1, f) = 0$ , contradicting the assertion above.

QED



As a corollary of Theorem 4.6 we obtain the following "nonembedding theorem":

**4.7. Theorem.** *A compact nonorientable  $n$ -manifold without boundary cannot be embedded in a simply connected  $(n + 1)$ -manifold. In particular projective  $2n$ -space  $P^{2n}$  does not embed in  $\mathbb{R}^{2n+1}$  for  $n \geq 1$ .*

*Proof.* A simply connected manifold is orientable; together with Theorems 4.6 and 4.5, this proves the first statement. To prove the second we show that  $P^{2n}$  is nonorientable. Consider  $P^{2n}$  as the identification space of  $S^{2n}$  by the antipodal map  $A$ ; let  $p: S^{2n} \rightarrow P^{2n}$  be the projection. We know that  $A$  is orientation reversing. Therefore  $P^{2n}$  cannot be orientable; for if  $\omega$  is an orientation of  $P^{2n}$ , there is a unique orientation  $\theta$  of  $S^{2n}$  such that  $T_x p(\theta_x) = \omega_{p(x)}$  for all  $x \in S^{2n}$ . But such a  $\theta$  would be invariant under the antipodal map, which is impossible.

QED

Theorem 4.7 is false if "simply connected" is replaced by "orientable": for  $P^{2n}$  embeds in the orientable manifold  $P^{2n+1}$ .

It is also true that  $P^{2n+1}$  does not embed in  $\mathbb{R}^{2n+2}$ , but more subtle methods are required.

### Exercises

1. If  $\xi$  is any vector bundle,  $\xi \oplus \xi$  is orientable. This implies that  $TM$  is orientable as a manifold.
2. There are precisely two isomorphism classes of  $n$ -plane bundles over  $S^1$  for each  $n \geq 1$ . Two such bundles are isomorphic if and only if both are orientable or both are nonorientable.
3.  $M \times N$  is orientable if and only if  $M$  and  $N$  are both orientable.
4. Every Lie group is an orientable manifold.  
(In Exercises 5 through 9,  $M \subset N$  is a closed, codimension 1 submanifold.)
5. If  $\partial M \neq \emptyset$  and  $\partial N = \emptyset$  and  $M, N$  are connected, then  $N - M$  is connected.
6. Suppose  $N = \mathbb{R}^{n+1}$ ,  $M$  is compact and  $\partial M = \emptyset$ . Then  $M$  bounds a unique compact submanifold of  $\mathbb{R}^{n+1}$ .
7. Suppose  $M$  is a neat submanifold. Then the normal bundle of  $M$  in  $N$  is trivial if and only if  $M$  has arbitrarily small neighborhoods in  $N$  that are separated by  $M$ .
8. Suppose  $\partial N = \partial M = \emptyset$ . If  $M$  is contractible to a point in  $N$  then  $M$  separates  $N$ .
9. If  $M = \partial W$  where  $W \subset N$  is a compact submanifold, and  $W \neq N$ , then  $M$  separates  $N$ .
10. Isomorphism classes of oriented  $k$ -plane bundles over an  $n$ -manifold  $M$  correspond naturally to homotopy classes of maps from  $M$  to the Grassman manifold  $G_{s,k}$  of oriented  $k$ -planes in  $\mathbb{R}^s$ , provided  $s > k + m$ .

\*11. Let  $\xi \rightarrow B$  be a nonorientable vector bundle over a connected manifold  $M$ . The set of homotopy classes of orientation-preserving loops at  $x_0 \in M$  form a subgroup of index 2 in  $\pi_1(M, x_0)$ .

12. Let  $M$  be a connected orientable manifold. The subgroup  $\text{Diff}_*(M)$  of orientation preserving diffeomorphisms is normal and has index 1 or 2 in  $\text{Diff}(M)$ ,  $1 \leq r \leq \infty$ . Moreover  $\text{Diff}_*(M)$  is open and closed in both the weak and strong topologies.

## 5. Tubular Neighborhoods

Let  $M \subset V$  be a submanifold. A *tubular neighborhood* of  $M$  (or for  $(V, M)$ ) is a pair  $(f, \xi)$  where  $\xi = (p, E, M)$  is a vector bundle over  $M$  and  $f: E \rightarrow V$  is an embedding such that:

1.  $f|M = 1_M$  where  $M$  is identified with the zero section of  $E$ ;
2.  $f(E)$  is an open neighborhood of  $M$  in  $V$ .

More loosely, we often refer to the open set  $W = f(E)$  as a tubular neighborhood of  $M$ . It is then to be understood that associated to  $W$  is a particular retraction  $q: W \rightarrow M$  making  $(q, W, M)$  a vector bundle whose zero section is the inclusion  $M \rightarrow W$ .

It is easy to see that only neat submanifolds can have tubular neighborhoods.

A slightly more general concept is that of a *partial tubular neighborhood* of  $M$ . This means a triple  $(f, \xi, U)$  where  $\xi = (p, E, M)$  is a vector bundle over  $M$ ,  $U \subset E$  is a neighborhood of the zero section and  $f: U \rightarrow V$  is an embedding such that  $f|M = 1_M$  and  $f(U)$  is open in  $V$ .

A partial tubular neighborhood  $(f, \xi, U)$  contains a tubular neighborhood, in the following sense: there is a tubular neighborhood  $(g, \xi)$  of  $M$  in  $V$  such that  $g = f$  in a neighborhood of  $M$ .

To construct  $g$ , fix an orthogonal structure on  $\xi$ . Choose a map  $\rho: M \rightarrow \mathbb{R}_+$  such that if  $y \in E_x$  and  $|y| \leq \rho(x)$  then  $y \in f(U)$ . Let  $\lambda: [0, \infty) \rightarrow [0, 1]$  be a diffeomorphism equal to the identity near 0. Define an embedding

$$h: E \rightarrow E,$$

$$h(y) = \rho(p(y))\lambda(|y|)|y|^{-1}y.$$

Then  $h(E) \subset U$  and  $h = \text{identity}$  near  $M$ . Now put  $g = fh$ .

Eventually (Theorem 6.3) we shall prove that every neat submanifold has a tubular neighborhood. The first step is to prove:

**5.1. Theorem.** *Let  $M \subset \mathbb{R}^n$  be a submanifold without boundary. Then  $M$  has a tubular neighborhood in  $\mathbb{R}^n$ .*

*Proof.* It suffices to find a partial tubular neighborhood.

Put  $k = n - \dim M$  and let  $\gamma_{n,k} \rightarrow G_{n,k}$  be the Grassmann bundle (see Section 4.3). Let  $\nu: M \rightarrow G_{n,k}$  be a  $(C^\infty)$  field of transverse  $k$ -planes: this means that for each  $x \in M$ , the tangent plane  $M_x \subset \mathbb{R}^n$  is transverse to the  $k$ -plane  $\nu(x)$ . For example, one could take  $\nu(x) = M_x^\perp$ .

Put

$$\xi = (p, E, M) = v^* \gamma_{n, k};$$

thus  $\xi$  is a vector bundle, and

$$E = \{(x, y) \in M \times \mathbb{R}^n : y \in v(x)\}.$$

Define a map

$$f: E \rightarrow \mathbb{R}^n$$

$$f(x, y) = x + y \quad (y \in v(x)).$$

The tangent space to  $E$  at a point  $(x, 0)$  of the zero section has a natural splitting  $M_x \oplus v(x)$ . It is clear that  $T_{(x, 0)} f$  is the identity on  $M_x$  and on  $v(x)$ . Therefore  $Tf$  has rank  $n$  at all points of the zero section and it follows that  $f$  is an immersion of some neighborhood of the zero section. Since  $f|_M = 1_M$  it follows that from Exercise 7, Section 2.1,  $f|_U$  is an embedding of some open neighborhood  $U \subset E$  of  $M$ . Thus  $(f, \xi, U)$  is a partial tubular neighborhood of  $M$ .

QED

In the above construction, if we choose  $v(x) = M_x^\perp$  the resulting tubular neighborhood is called a *normal tubular neighborhood* of  $M$  in  $\mathbb{R}^n$ . It is not hard to prove that in this case  $U$  can be chosen small enough so that  $f(U \cap v_x)$  is the set of points in  $f(U)$  whose nearest point of  $M$  is  $x$ . See Figure 4-1.

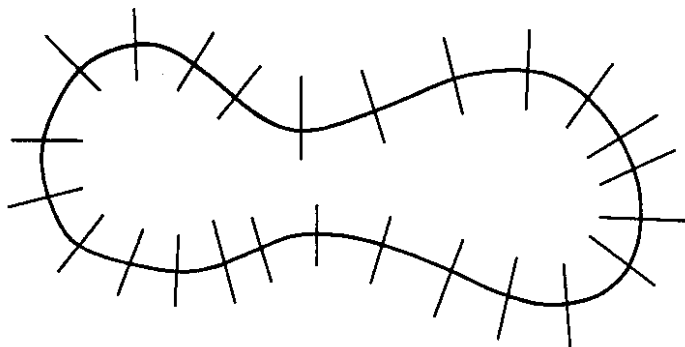

Figure 4-1. A normal tubular neighborhood.

**5.2. Theorem.** Let  $M \subset V$  be a submanifold,  $\partial M = \partial V = \emptyset$ . Then  $M$  has a tubular neighborhood in  $V$ .

*Proof.* We may assume  $V \subset \mathbb{R}^n$ . Let  $W \subset \mathbb{R}^n$  be a neighborhood of  $V$  and  $r: W \rightarrow V$  a  $C^\infty$  retraction. (Such a  $W$  and  $r$  exist because  $V$  has a tubular neighborhood in  $\mathbb{R}^n$ .) Give  $V$  the Riemannian metric induced from  $\mathbb{R}^n$  and let  $v = (p, E, M)$  be the normal bundle of  $M$  in  $V$ . Thus

$$v \subset T_M V \subset T_M \mathbb{R}^n = M \times \mathbb{R}^n;$$

each fibre  $v_x$  is contained in  $x \times \mathbb{R}^n$ .

For each  $x \in M$  let

$$U_x = \{(x, y) \in v_x : x + y \in W\}.$$

Put  $U = \bigcup_{x \in M} U_x$ . Then  $U$  is open in  $E$ , being the inverse image of  $W$  under the map

$$E \rightarrow \mathbb{R}^n,$$

$$(x, y) \mapsto x + y \quad (y \in v_x).$$

It is easy to verify that the map

$$f: U \rightarrow V,$$

$$f(x, y) = r(x + y)$$

provides a partial tubular neighborhood for  $(V, M)$ .

QED

It is useful to be able to slide one tubular neighborhood of a submanifold onto another one, mapping fibres linearly onto fibres. Such a sliding is a special case of an isotopy. Isotopies will be considered in more generality in a later chapter; at present the following remarks suffice.

If  $P, Q$  are manifolds, an *isotopy* of  $P$  in  $Q$  is a homotopy

$$F: P \times I \rightarrow Q,$$

$$F(x, t) = F_t(x)$$

such that the related map

$$\hat{F}: P \times I \rightarrow Q \times I,$$

$$(x, t) \mapsto (F_t(x), t)$$

is an embedding. We call  $\hat{F}$  the *track* of  $F$ . We also say  $F$  is an isotopy from  $F_0$  to  $F_1$ . If  $A \subset P$  is such that  $F_t(x) = F_0(x)$  for all  $(x, t) \in A \times I$  then  $F$  is a *rel A isotopy*.

The relation “ $f$  is isotopic to  $g$ ” is transitive. For let  $F, G$  be isotopies of  $P$  in  $Q$  such that  $F_1 = G_0$ . We can almost define an isotopy  $H$  from  $F_0$  to  $G_1$  by setting

$$H_t = \begin{cases} F_{2t} & 0 \leq t \leq \frac{1}{2} \\ G_{2t-1} & \frac{1}{2} \leq t \leq 1; \end{cases}$$

but  $H$  is not necessarily smooth at points of  $P \times \frac{1}{2}$ . The solution is to write instead:

$$H_t = \begin{cases} F_{\tau(2t)}, & 0 \leq t \leq \frac{1}{2} \\ G_{\tau(2t-1)}, & \frac{1}{2} \leq t \leq 1 \end{cases}$$

where  $\tau: I \rightarrow I$  is a  $C^\infty$  map which collapses a neighborhood of  $i$  to  $i$  for  $i = 0, 1$ . This  $H$  is indeed an isotopy from  $F_0$  to  $G_1$ .

The same argument shows that rel  $A$  isotopy is an equivalence relation.

Now let  $(f_i, \xi_i = (p_i, E_i, M))$  be a tubular neighborhood of  $M \subset V$  for  $i = 0, 1$ . An *isotopy of tubular neighborhoods* from  $(f_0, \xi_0)$  to  $(f_1, \xi_1)$  is a rel

$M$  isotopy  $F$  from  $E_0$  to  $V$  such that:

$$F_0 = f_0,$$

$$F_1(E_0) = f_1(E_1),$$

$$f_1^{-1}F_1: E_0 \rightarrow E_1 \text{ is a vector bundle isomorphism } \xi_0 \rightarrow \xi_1,$$

and

$$\hat{F}(E_0 \times I) \text{ is open in } V \times I.$$

This last condition is automatic if  $\partial M = \emptyset$ .

One thinks of  $\{F_t(E_0)\}_{t \in I}$  as a one-parameter family of tubular neighborhoods of  $M$ . Notice also that  $\hat{F}$  defines a tubular neighborhood  $(\hat{F}, \xi \times I)$  of  $M \times I$  in  $V \times I$ .

It is easy to see that isotopy is an equivalence relation on the class of tubular neighborhoods for  $(V, M)$ .

**5.3. Theorem.** *Let  $M \subset V$  be a submanifold,  $\partial M = \partial V = \emptyset$ . Then any two tubular neighborhoods of  $M$  in  $V$  are isotopic.*

*Proof.* Let the tubular neighborhoods be  $(f_i, \xi_i = (p_i, E_i, M))$ ,  $i = 0, 1$ . First suppose  $f_0(E_0) \subset f_1(E_1)$ .

Let  $\Phi: \xi_0 \rightarrow \xi_1$  be the fibre derivative of  $g = f_1^{-1}f_0: E_0 \rightarrow E_1$ . Thus  $\Phi$  is the component along the fibres of the morphism

$$T_M g: T_M E_0 = TM \oplus \xi_0 \rightarrow TM \oplus \xi_1 = T_M E_1,$$

which shows that  $\Phi$  is an isomorphism of vector bundles.

We define the canonical homotopy from  $\Phi$  to  $g$  to be

$$(1) \quad H(x, y) = \begin{cases} t^{-1}g(tx) & \text{if } 1 \geq t > 0, \\ \Phi(x) & \text{if } t = 0. \end{cases}$$

(Here  $tx$  means scalar multiplication in the fibre containing  $x$ , etc.)

We claim  $H$  is  $C^\infty$ . This is a local statement; to prove it we can work in charts for  $M$ ,  $\xi_0$  and  $\xi_1$ . Such charts make  $g$  locally a  $C^\infty$  embedding

$$\begin{aligned} g: U \times \mathbb{R}^k &\rightarrow \mathbb{R}^m \times \mathbb{R}^k, \\ g(x, y) &= (g_1(x, y), g_2(x, y)), \\ g(x, 0) &= (x, 0) \end{aligned}$$

where  $U \subset \mathbb{R}^k$  is open. Locally,  $\Phi$  becomes the fibre derivative of  $g$ :

$$\begin{aligned} \Phi: U \times \mathbb{R}^k &\rightarrow \mathbb{R}^m \times \mathbb{R}^k, \\ \Phi(x, y) &= \left( x, \frac{\partial g_2}{\partial y}(x, 0)y \right). \end{aligned}$$

Here  $\partial g_2 / \partial y$  assigns to each point of  $U \times \mathbb{R}^k$  a linear map  $\mathbb{R}^k \rightarrow \mathbb{R}^k$ . The local representation of  $H$  is a map  $(U \times \mathbb{R}^k) \times I \rightarrow \mathbb{R}^m \times \mathbb{R}^k$  given by the same formula (1).

By Taylor's formula we can write

$$(2) \quad g_2(x, y) = \frac{\partial g_2}{\partial y}(x, 0)y + \langle s(x, y), y \rangle$$

where  $\langle, \rangle$  is the inner product in  $\mathbb{R}^k$  and  $s: U \times \mathbb{R}^k \rightarrow \mathbb{R}^k$  is a  $C^\infty$  map with  $s(x, 0) = 0$ .

It is trivial to verify that the first coordinate of (the local representation of)  $H$  as given by (1) defines a  $C^\infty$  map  $U \times \mathbb{R}^m \times I \rightarrow \mathbb{R}^m$ . By (2) the second coordinate of  $H$  is given by the formula

$$\frac{\partial g_2}{\partial y}(x, 0)y + \langle s(x, ty), y \rangle, \quad 1 \geq t \geq 0.$$

Clearly this is  $C^\infty$  in  $(t, x, y)$ . Thus  $H$  is  $C^\infty$ ; and it is easily verified that  $H$  is an isotopy.

An isotopy of tubular neighborhoods from  $(f_0, \xi_0)$  to  $(f_1, \xi_1)$  is now defined by

$$F(x, t) = f_1^{-1}H(x, 1 - t),$$

under the assumption that  $f_0(E_0) \subset f_1(E_1)$ .

For the general case we first pull  $E_0$  into the open set  $f_0^{-1}f_1(E_1) \subset E_0$  by a preliminary isotopy of the form

$$G: E_0 \times I \rightarrow E_0,$$

$$G(z, t) = (1 - t)y + th(y)$$

where

$$h: E_0 \rightarrow E_0,$$

$$h(y) = \left[ \frac{\delta(p(y))}{1 + y^2} \right] y$$

and  $\delta: M \rightarrow \mathbb{R}_+$  is a suitably small  $C^\infty$  map.

Thus  $(f_0, \xi_0)$  and  $(f_0 G_1, \xi_0)$  are isotopic tubular neighborhoods; and since  $f_0 G_1$  maps  $E_0$  into  $f_1(E_1)$ , so are  $(f_0 G_1, \xi_0)$  and  $(f_1, \xi_1)$ . Theorem 5.3 now follows from transitivity of the relation of isotopy.

QED

### 6. Collars and Tubular Neighborhoods of Neat Submanifolds

The boundary of a manifold cannot have a tubular neighborhood. However, it has a kind of "half-tubular" neighborhood called a collar. A collar on  $M$  is an embedding

$$f: \partial M \times [0, \infty) \rightarrow M$$

such that  $f(x, 0) = x$ . The following is the collaring theorem:

**6.1. Theorem.**  *$\partial M$  has a collar.*

*Proof.* A proof using differential equations is given in Section 5.2. An alternative proof is outlined as follows.

First, find a  $C^\infty$  retraction  $r: W \rightarrow \partial M$  of a neighborhood of  $\partial M$  onto  $\partial M$ . This is obviously possible locally, and two local retractions into coordinate domains can be glued together with a bump function. A standard globalization technique (e.g., Theorem 2.2.11) produces a global retraction.

Second, find a neighborhood  $U \subset M$  of  $\partial M$  and a map

$$g: U \rightarrow [0, \infty),$$

$$g(\partial M) = 0$$

having 0 as a regular value. This is easily done with a partition of unity. Third, observe that the map

$$h = (r, g): W \rightarrow \partial M \times [0, \infty)$$

maps a neighborhood of  $\partial M$  diffeomorphically onto a neighborhood  $W \subset \partial M \times [0, \infty)$ , and  $h(x) = (x, 0)$  for  $x \in \partial M$ .

Finally, let  $\varphi: \partial M \times [0, \infty) \rightarrow h(W)$  be an embedding which fixes  $\partial M \times 0$ . Then  $h^{-1}\varphi$  is a collar.

QED

It is also true that boundaries of  $C^0$  manifolds have collars, although this is far from obvious. An elegant and surprising proof is given by M. Brown [2].

We leave as an exercise the proof of the following refinement of Theorem 6.1:

**6.2. Theorem.** *Let  $M \subset V$  be a closed neat submanifold. Then  $\partial V$  has a collar which restricts to a collar on  $\partial M$  in  $M$ .*

Having collars at our disposal we can now prove:

**6.3. Theorem.** *Let  $M \subset V$  be a neat submanifold. Then  $M$  has a tubular neighborhood in  $V$ .*

*Proof.* By Theorem 6.2 there is a neighborhood  $N \subset V$  of  $\partial V$  and a diffeomorphism

$$\varphi: (N, \partial V) \approx (\partial V \times I, \partial V \times 0)$$

such that

$$\varphi: N \cap \partial M \approx \partial M \times I.$$

Let  $q > 2 \dim V$ . Embed  $\partial V$  in  $\mathbb{R}^{q-1}$ ; extend this to an embedding

$$\partial V \times I \rightarrow \mathbb{R}^{q-1} \times [0, \infty) = \mathbb{R}_+^q$$

$$(x, t) \mapsto (x, t).$$

We can thus assume  $N \subset \mathbb{R}_+^q$  in such a way that every vector of  $\mathbb{R}^q$  which is normal to  $N$  at a point of  $\partial V$ , or normal to  $N \cap M$  at a point of  $\partial V$ , is in  $\mathbb{R}^{q-1}$ . See Figure 4-2.

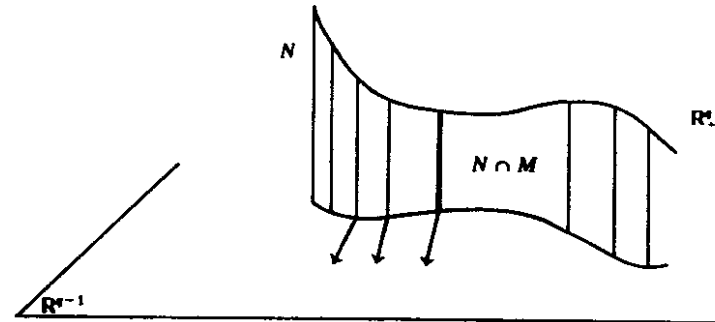

Figure 4-2. An embedding of  $N$  in  $\mathbb{R}_+^q$ .

We can extend the embedding of  $N$  to an embedding of  $V$  in  $\mathbb{R}_+^q$ . Thus  $V$  is now a neat submanifold of  $\mathbb{R}_+^q$ , and both  $V$  and  $M$  meet  $\mathbb{R}^{q-1}$  orthogonally along  $\partial V$  and  $\partial M$ .

We can now find a normal tubular neighborhood of  $V$  in  $\mathbb{R}_+^q$  (Figure 4-3), and the rest of the proof is like that of Theorem 5.2.

QED

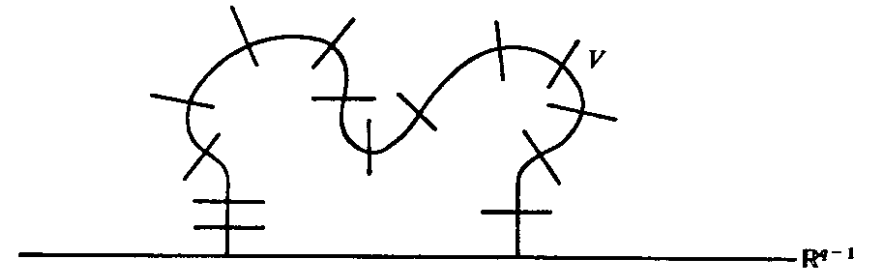

Figure 4-3. A normal tubular neighborhood of  $V$  in  $\mathbb{R}_+^q$ .

The following extension theorem for tubular neighborhoods is useful:

**6.4. Theorem.** *Let  $M \subset V$  be a neat submanifold. Then every tubular neighborhood of  $\partial M$  in  $\partial V$  is the intersection with  $\partial V$  of a tubular neighborhood for  $M$  in  $V$ .*

*Proof.* First consider the special case  $V = W \times I$ ,  $M = N \times I$  where  $N \subset W$  is a submanifold and  $\partial N = \partial W = \emptyset$ . Then

$$\partial V = W \times 0 \cup W \times 1$$

$$\partial N = N \times 0 \cup N \times 1.$$

In this case a tubular neighborhood for  $(\partial V, \partial M)$  is just a pair of tubular neighborhood for  $(W, N)$ . Let these be  $E_0, E_1$ . By Theorem 5.3 there is an isotopy of tubular neighborhoods from  $E_0$  to  $E_1$ , say  $F: E_0 \times I \rightarrow W$ .

Then the corresponding embedding

$$\begin{aligned}\hat{F}: E_0 \times I &\rightarrow W \times I = W \\ \hat{F}(x,t) &= (F(x,t), t)\end{aligned}$$

a tubular neighborhood for  $N \times I = M$  in  $V$ , restricts to  $E_0$  and  $E_1$  in  $\partial V$ .

Now consider the general case. Give  $\partial V$  a collar in  $V$  which contain a collar on  $\partial M$  in  $M$ ; we shall identify  $\partial V \times [0, \infty)$  with a neighborhood of  $\partial V$  in  $V$ , so that  $\partial M \times [0, \infty)$  corresponds to a neighborhood of  $\partial M$  in  $M$ . Put

$$\begin{aligned}V' &= \partial V \times [0, 1], & M' &= \partial M \times [0, 1] \\ V'' &= \partial V \times [1, \infty), & M'' &= \partial M \times [1, \infty).\end{aligned}$$

Thus  $V = V' \cup V''$ ,  $V' \cap V'' = \partial V \times 1$ , and similarly for  $M$ .

Let  $E_0$  be a tubular neighborhood for  $\partial M$  in  $\partial V$ . By 6.3 there is a tubular neighborhood  $E''$  of  $M''$  in  $V''$ . Let  $E_1 = E'' \cap \partial V \subset \partial V \times 1$ . Thus  $E_0$  and  $E_1$  form a tubular neighborhood for  $M \times \{0, 1\}$  in  $V \times \{0, 1\}$ . By the special case  $E_0 \cup E_1$  extends to a tubular neighborhood  $E'$  of  $V'$  in  $M'$ . Then  $E' \cup E''$  is a tubular neighborhood  $M$  in  $V$  which extends  $E_0$ . (Actually one has to make sure that  $E'$  and  $E''$  fit together smoothly at  $\partial V''$ ; this is left to the reader.)

QED

A closed tubular neighborhood of radius  $\varepsilon > 0$ , of a submanifold  $M \subset V$ , is an embedding  $D_\varepsilon(\xi) \rightarrow M$  which is the restriction of a tubular neighborhood  $(f, \xi = (p, E, M))$  of  $M$ . Here

$$D_\varepsilon(\xi) = \{x \in E: |x| \leq \varepsilon\}$$

is the disk subbundle of  $\xi$  of radius  $\varepsilon$ , for a given orthogonal structure on  $\xi$ .

The isotopy theorem for closed tubular neighborhoods is as follows:

**6.5. Theorem.** Let  $M \subset V$  be a submanifold. Let  $\xi_i = (p_i, E_i, M)$  be orthogonal vector bundles over  $M$ ,  $i = 0, 1$ . Let  $(f_i, \xi_i)$  be a tubular neighborhood of  $M$ . Let  $\varepsilon > 0$ ,  $\delta > 0$ . Then  $(f_0, \xi_0)$  and  $(f_1, \xi_1)$  are isotopic by an isotopy of tubular neighborhoods  $F_t: E \rightarrow V$ ,  $0 \leq t \leq 1$ , such that  $F_0 = f_0$  and

$$F_1(D_\varepsilon(\xi_0)) = D_\delta(\xi_1).$$

*Proof.* By Theorem 5.3 and a preliminary isotopy we may assume that, as tubular neighborhoods,  $(f_0, \xi_0) = (f_1, \xi_1)$ ; but  $D_\varepsilon(\xi_0)$  and  $D_\delta(\xi_1)$  might be defined by different orthogonal structures. However, by 2.3 and a linear isotopy we may assume that these orthogonal structures are identical. The theorem is now obvious: in any orthogonal vector bundle there is a linear isotopy carrying  $D_\varepsilon(\xi)$  onto  $D_\delta(\xi)$ .

QED

As a very special but useful case, let  $M$  be a point  $x_0 \in V$ . An open tubular neighborhood of  $x_0$  is an embedding  $(\mathbb{R}^n, 0) \rightarrow (V, x_0)$  and a closed tubular

neighborhood of radius 1 is an embedding  $(D^n, 0) \rightarrow (V, x_0)$ , where  $n = \dim V$ . (We suppose  $\partial V = \emptyset$ .)

**6.6. Theorem.** Let  $E^n = D^n$  or  $\mathbb{R}^n$  and let  $f_i: (E^n, 0) \rightarrow (V, x_0)$  be an embedding,  $i = 0, 1$ , where  $n = \dim V$ . If

$$\text{Det}(D(f_1^{-1}f_0)(0)) > 0$$

then  $f_0$  and  $f_1$  are isotopic rel 0.

*Proof.* Note that  $f_1^{-1}f_0$  is well defined on a neighborhood of 0 in  $E^n$ , so its derivative at 0 is defined. By isotopy of tubular neighborhoods we can assume  $f_1^{-1}f_0$  is a linear automorphism  $L \in GL(n)$ . If  $\det L > 0$  then  $L$  is connected to the identity in  $GL(n)$  by an arc  $L_t$ ,  $0 \leq t \leq 1$ :

$$L_0 = f_1^{-1}f_0, \quad L_1 = 1_{\mathbb{R}^n}.$$

The required isotopy from  $f_0$  to  $f_1$  is

$$f_1 L_t^{-1} f_1^{-1} f_0, \quad 0 \leq t \leq 1.$$

QED

One use for tubular neighborhoods is to make a map look like a vector bundle map (after a homotopy). Let  $V, N$  be manifolds,  $A \subset N$  a compact neat submanifold and  $f: V \rightarrow N$  a map such that  $f$  and  $f|_{\partial V}$  are both transverse to  $A$ . Put  $M = f^{-1}(A)$ , a neat submanifold of  $V$ . Suppose given tubular neighborhoods  $U \subset V$  of  $M$  and  $E \subset N$  of  $A$ . Let  $D \subset U$  be a disk subbundle such that  $f(D) \subset E$ .

**6.7. Theorem.** Under the assumptions above, there is a homotopy  $f_t$  from  $f = f_1$  to a map  $f_0 = h: V \rightarrow N$  such that:

- $h|_D$  is the restriction of a vector bundle map  $U \rightarrow E$  over  $f: M \rightarrow A$ ;
- $f_t = f$  on  $M \cup (N - U)$ ,  $0 \leq t \leq 1$ .
- $f_t^{-1}(N - A) = V - M$ ,  $0 \leq t \leq 1$ .

*Proof.* Let  $\Phi: U \rightarrow E$  be the vector bundle map, over  $f: M \rightarrow A$ , which is the fibre derivative of  $f: D \rightarrow E$ . Let  $f_t: D \rightarrow E$ ,  $1 \geq t \geq 0$  be the canonical homotopy from  $f_1 = f|_D$  to  $f_0 = \Phi|_D$ :

$$f_t(x) = \begin{cases} t^{-1}f(tx), & 1 \geq t \geq 0, \\ \Phi(x), & t = 0. \end{cases}$$

Notice that  $f_t(\partial D) \subset N - A$ .

Let  $D' \subset U$  be a disk subbundle with  $D' \subset \text{int } D$ . Put  $D' - \text{int } D = L$ ; thus  $\partial L = \partial D' \cup \partial D$ . Define a homotopy

$$g_t = \begin{cases} g_t: \partial L \rightarrow N - A, \\ \begin{cases} f_t & \text{on } \partial D, \\ f & \text{on } \partial D'. \end{cases} \end{cases}$$

By homotopy extension (Theorem 1.4)  $g_t$  extends to a homotopy

$g_i: L \rightarrow N - A$ . Define a homotopy

$$h_i: V \rightarrow N,$$

$$h_i = \begin{cases} f & \text{on } V - D' \\ g_i & \text{on } L \\ f_i & \text{on } D. \end{cases}$$

The required map is then  $h = h_0$ .

QED

**Exercises**

- 1. There is an obvious definition of  $C^r$  tubular neighborhood and  $C^r$  isotopy,  $1 \leq r < \infty$ . A neat  $C^r$  submanifold has a  $C^r$  tubular neighborhood, unique up to  $C^r$  isotopy.
- \*2. Let  $M_0, M_1$  be neat submanifolds of  $V$  in general position. Let  $(f_i, \xi_i)$  be a tubular neighborhood of  $M_0 \cap M_1$  in  $M_i$ ,  $i = 0, 1$ . Then there is a tubular neighborhood  $(f, \xi_0 \oplus \xi_1)$  of  $M_0 \cap M_1$  in  $V$  such that  $f|_{\xi_i} = f_i$ .
- \*3. *Extendability of germs of tubular neighborhoods.* Let  $M \subset V$  be a neat submanifold and  $U \subset M$  a neighborhood of a closed subset  $A \subset M$ . For every tubular neighborhood  $E_0$  of  $U$  in  $V$  there is a tubular neighborhood  $E$  of  $M$  in  $V$ , and a neighborhood  $W \subset U$  of  $A$ , such that  $E|_W = E_0|_W$ .
- 4. Let  $D \subset M$  be a neat  $p$ -disk of codimension  $k$ . Then  $D$  has a neighborhood  $E \subset M$  such that

$$(E, D) \approx (D^p \times \mathbb{R}^k, D^p \times 0).$$

- 5. Let  $M \subset V$  be a closed neat submanifold of codimension  $k$ . Then there is a map  $f: (V, M) \rightarrow (S^k, p)$  such that  $p$  is a regular value and  $f^{-1}(p) = M$ , if and only if  $M$  has a trivial normal bundle.
- 6. Let  $M \subset \mathbb{R}^n$  be a submanifold of codimension  $k$ ,  $\partial M = \emptyset$ . Let  $v: M \rightarrow G_{n,k}$  be a transverse field of  $k$ -planes. Suppose that  $v$  locally satisfies Lipschitz conditions with respect to Riemannian metrics on  $M$  and  $G_{n,k}$ . Then  $M$  has a tubular neighborhood  $U \subset \mathbb{R}^n$  whose fibre over  $x \in M$  is the intersection of  $U$  and the  $k$ -plane through  $x$  parallel to  $v(x)$ . But if  $v$  is merely continuous this may be false, even for  $S^1 \subset \mathbb{R}^2$ .
- 7. The boundary of a nonparacompact manifold does not necessarily have a collar. For instance there is a 2-dimensional manifold  $M$  such that  $M - \partial M \approx \mathbb{R}^2$  but  $\partial M$  has uncountably many components (each diffeomorphic to  $\mathbb{R}$ ).
- \*8. Let  $L$  be the long line with its natural ordering (see Exercise 2, Section 1.1) and set

$$M = \{(x, y) \in L \times L : x \leq y\}.$$

Then  $M$  is a  $\partial$ -manifold with  $\partial M \approx L$ . Show  $\partial M$  has no collar.

- \*9. *Ambient isotopy of closed tubular neighborhoods.* In Theorem 6.5, the isotopy  $F_t|_{D_\epsilon(\xi_0)}$  can be achieved through a diffeotopy of  $V$ . That is, there is an isotopy  $G_t: V \rightarrow V$ ,  $0 \leq t \leq 1$ , such that  $G_0 = 1_V$ , and  $F_t(x) = G_t f_0(x)$  for  $x \in D_\epsilon(\xi_0)$ .

**7. Analytic Differential Structures**

We shall use tubular neighborhoods and transversality to prove the following result:

**7.1. Theorem (Whitney).** *Let  $M$  be a compact manifold without boundary. Then  $M$  is diffeomorphic to an analytic submanifold of Euclidean space.*

*Proof.* We may assume  $M$  embedded in  $\mathbb{R}^n$  with codimension  $k$ . Let  $E \subset \mathbb{R}^n$  be a normal tubular neighborhood of  $M$ . We identify  $E$  with a neighborhood of the zero section of the normal bundle of  $M$ . Let  $p: E \rightarrow M$  be the restriction of the bundle projection.

Let  $h: M \rightarrow G_{n,k}$  be the map sending  $x \in M$  to the  $k$ -plane normal to  $M$  at  $x$ . Let  $E_{q,k} \rightarrow G_{q,k}$  be the Grassmann  $k$ -plane bundle and let  $f: E \rightarrow E_{q,k}$  be the natural map covering  $h$ ; thus

$$f(y) = (h(y), y) \in E_{q,k} \subset G_{q,k} \times \mathbb{R}^n.$$

Note that  $f$  is transverse to the zero section  $G_{q,k} \subset E_{q,k}$  and

$$f^{-1}(G_{q,k}) = M.$$

The main point of the proof is to  $C^1$  approximate  $f$  by an analytic map. For this we use Theorem 2.5.2. That result says that a real-valued  $C^r$  map ( $0 \leq r \leq \infty$ ) on an open subset of Euclidean space can be  $C^r$  approximated, near a compact set, by an analytic map. The same result clearly holds for maps into  $\mathbb{R}^s$ . Moreover it holds for maps from open subsets  $E \subset \mathbb{R}^n$  into a  $C^\infty$  submanifold  $N \subset \mathbb{R}^s$ . For a normal tubular neighborhood of  $N$  provides a  $C^\infty$  retraction  $\rho: W \rightarrow N$  where  $W \subset \mathbb{R}^s$  is an open set. Given  $f: E \rightarrow N$ , the required  $C^\infty$  approximation is  $\rho \circ f'$  where  $f': E \rightarrow W$  is a  $C^\infty$  approximation to  $f$ .

Now  $E_{q,k}$  embeds analytically in  $\mathbb{R}^s$  with  $s = q^2 + q$ . For this it suffices to embed  $G_{q,k}$  in  $\mathbb{R}^{q^2}$ . This is done by mapping a  $k$ -plane  $P \in G_{q,k}$  to the linear map  $\mathbb{R}^k \rightarrow \mathbb{R}^q$  given by orthogonal projection on  $P$ .

It follows that the map  $f: E \rightarrow E_{q,k}$  can be approximated near  $M$  by an analytic map  $\varphi: E \rightarrow E_{q,k}$ . Put  $M' = \varphi^{-1}(G_{q,k})$ . If  $\varphi$  is sufficiently  $C^1$  close to  $f$  then  $\varphi \upharpoonright G_{q,k}$  and the restriction of  $p: E \rightarrow M$  to  $M'$  is a  $C^\infty$  diffeomorphism  $M' \approx M$ .

QED

Of course stronger results can be proved by using the powerful Remmert-Grauert approximation Theorem 2.5.1. The proof given used only the elementary Theorem 2.5.2.

**Exercises**

- 1. Let  $f: M \rightarrow \mathbb{R}^n$  be an embedding where  $M$  is compact without boundary. Then  $f$  can be approximated by embeddings  $g$  such that  $g(M)$  is an analytic submanifold.
- 2. Let  $M \subset \mathbb{R}^n$  and  $N \subset \mathbb{R}^n$  be analytic submanifolds without boundaries, with  $M$  compact. Then analytic maps are dense in  $C^r_w(M, N)$ ,  $0 \leq r \leq \infty$ .
- 3. Let  $\xi$  be a  $C^r$  vector bundle over  $M$ , where  $M$  is a compact analytic submanifold of Euclidean space,  $0 \leq r \leq \infty$ , and  $\partial M = \emptyset$ . Then  $\xi$  has a compatible  $C^\infty$  vector bundle structure, unique up to  $C^\infty$  isomorphism.

## Chapter 5

# Degrees, Intersection Numbers, and the Euler Characteristic

Topology has the peculiarity that questions belonging in its domain may under certain circumstances be decidable even though the continua to which they are addressed may not be given exactly, but only vaguely, as is always the case in reality.

—H. Weyl, *Philosophy of Mathematics  
and Natural Science*, 1949

Geometry is a magic that works . . .

—R. Thom, *Stabilité Structurelle  
et Morphogénèse*, 1972

We now have enough machinery at our disposal to develop one of the most important tools in topology: the degree of a map  $f: M \rightarrow N$ , where  $M$  and  $N$  are compact  $n$ -manifolds,  $N$  is connected, and  $\partial M = \partial N = \emptyset$ . This degree is an integer if  $M$  and  $N$  are oriented, an integer mod 2 otherwise.

Intuitively, the degree is the number of times  $f$  wraps  $M$  around  $N$ . The precise definition requires the theories of approximation, regular values, and orientation. If  $f$  is  $C^1$  and if  $y \in N$  is a regular value, then the degree of  $f$  is the number of points in  $f^{-1}(y)$  at which  $Tf$  preserves orientation, minus the number of points at which  $Tf$  reverses orientation.

It turns out that the degree of  $f$  is the same for all maps homotopic to  $f$ . This has two important consequences: it makes the degree of any given map easy to compute, and it gives us a convenient method of distinguishing homotopy classes. Moreover the degree is the *only* homotopy invariant for maps into  $S^n$ ; this is the main result of Section 5.1.

With the introduction of the degree we enter the realm of algebraic topology. Many geometrical questions depend on the computation of degrees of maps; thus topology is translated to algebra, the continuous is reduced to the discrete.

The degree is actually a special case of a more general geometrical concept called the *intersection number*, developed in Section 5.2. If  $M$  and  $N$  are submanifolds of  $W$  of complementary dimensions, and  $M$  and  $N$  are in general position, their intersection number is the algebraic number of points in  $M \cap N$ , each counted with appropriate sign determined by orientations. By means of transversality theory, intersection numbers of maps  $M, N \rightarrow W$  can be defined; again we obtain homotopy invariants. If  $W$  is an  $n$ -dimensional oriented vector bundle  $\xi \rightarrow M$  then the self-intersection number of

the zero section is called the *Euler number*  $X(\xi)$ . This is an important isomorphism invariant of bundles. The Euler number of  $TM$  is the *Euler characteristic*  $\chi(M)$ .

We can compute  $X(\xi)$  by means of sections of  $\xi$ . This leads to the computation of  $\chi(M)$  as the sum of the indices of zeros of a vector field on  $M$ . In Chapter 6 we shall use the Morse inequalities to recompute  $\chi(M)$  as the alternating sum of the Betti numbers of  $M$ .

## 1. Degrees of Maps

In this section we exploit orientations and tubular neighborhoods to derive some classical homotopy and extension theorems.

Recall that Euclidean  $n$ -space  $\mathbb{R}^n$ ,  $n \geq 1$ , has the *standard orientation*  $\omega^n$  given by any basis whose coordinate matrix has positive determinant (and the orientation of  $\mathbb{R}^0$  is the number  $+1$ ). Every  $n$ -dimensional submanifold of  $\mathbb{R}^n$  is also given this orientation.

If  $(M, \omega)$ ,  $(N, \theta)$  are oriented manifolds, the *product orientation*  $\omega \times \theta$  for  $M \times N$  assigns to  $(x, y) \in M \times N$  the orientation  $\omega_x \otimes \theta_y$  of  $(M \times N)_{(x,y)} = M_x \otimes N_y$ .

Let  $(M, \omega)$  be an oriented  $\partial$ -manifold and  $f: \partial M \times [0, \infty) \rightarrow M$  a collar. Then  $T_{\partial M} f$  induces an isomorphism of the trivial bundle  $M \times \mathbb{R}$  onto the normal bundle  $\nu$  of  $\partial M$  in  $M$ . The standard orientation of  $\mathbb{R}$  orients each fibre of  $M \times \mathbb{R}$ ; via  $T_{\partial M} f$  this induces an orientation  $\iota$  of  $\nu$  which does not depend on the collar. In other words  $\nu$  is oriented by *inward pointing vectors tangent to  $M$  at  $\partial M$* .

We now have orientations  $\omega$  and  $\iota$  of  $M$  and  $\nu$ . From the exact sequence of vector bundles

$$0 \rightarrow T(\partial M) \rightarrow T_{\partial M} M \rightarrow \nu \rightarrow 0$$

we define the *induced orientation*  $\omega/\iota = \partial\omega$  of  $\partial M$ . Thus  $(e_1, \dots, e_{n-1})$  is an orienting basis for  $(\partial\omega)_x$  if  $(e_1, \dots, e_{n-1}, e_n)$  is an orienting basis for  $\omega_x$  and  $e_n$  points into  $M$  at  $x \in \partial M$ .

Let  $\theta$  be an orientation of  $M$ . We usually give  $M \times I$  the product orientation  $\omega = \theta \times \omega^1$  where  $\omega^1$  is the standard orientation of  $I$ . It follows that

$$\partial\omega|_{M \times 0} = \theta \quad \text{and} \quad \partial\omega|_{M \times 1} = -\theta.$$

We shall frequently speak of “the oriented manifold  $M$ ”, not naming the orientation explicitly. In this case  $\partial M$  and  $M \times I$  are also oriented manifolds, as is any submanifold of  $M$  of the same dimension. If  $-M$  denotes the manifold  $M$  with the opposite orientation, then

$$\partial(M \times I) = (M \times 0) \cup (-M \times 1)$$

as oriented manifolds.

The closed unit  $n$ -disk  $D^{n+1} \subset \mathbb{R}^{n+1}$  has the standard orientation. Therefore its boundary  $S^n$  inherits an orientation, also called “standard”. It is easy

to verify that stereographic projection from the north pole  $P = (0, \dots, 0, 1) \in S^n$  is an orientation preserving diffeomorphism  $S^n - P \approx \mathbb{R}^n$ . Thus if  $(e_1, \dots, e_n)$  is an orienting basis for  $\mathbb{R}^n \subset \mathbb{R}^{n+1}$ , an orienting basis for  $S^n$  at the south pole  $-P$  is  $(e_1, \dots, e_n)$ , while at the north pole  $(e_1, \dots, e_{n-1}, -e_n)$  is orienting.

Let  $A: \mathbb{R}^m \rightarrow \mathbb{R}^m$  be the antipodal map  $A(x) = -x$ . Since  $\text{Det } A = (-1)^m$  it follows that  $A$  preserves orientation of  $\mathbb{R}^m$  if and only if  $m$  is even. The antipodal map of  $\mathbb{R}^{n+1}$  restricts to a diffeomorphism of  $D^{n+1}$ . Since it clearly preserves orientation of the normal bundle of  $\partial D^{n+1}$ , it follows that  $A: S^n \rightarrow S^n$  preserves orientation if and only if  $n$  is odd.

**1.1. Lemma.** *Let  $(W, \omega)$  be an oriented  $\partial$ -manifold. Suppose  $K \subset W$  is an embedded arc which is transverse to  $\partial W$  at its endpoints  $u, v \in \partial W$ . Let  $\kappa$  be an orientation of  $K$ , and consider the quotient orientation  $\omega/\kappa$  of the algebraic normal bundle of  $K$ . Then*

$$\omega_u/\kappa_u = (\partial\omega)_u \Leftrightarrow \omega_v/\kappa_v = -(\partial\omega)_v.$$

*Proof.* Let  $X_u, X_v$  be tangent vectors to  $K$  at  $u, v$  which belong to  $\kappa_u, \kappa_v$  respectively. Then  $X_u$  is inward if and only if  $X_v$  is outward; this is equivalent to the lemma.

QED

Let  $(M, \omega), (N, \theta)$  be compact oriented manifolds of the same dimension, without boundaries. Assume  $N$  is connected. Let  $f: M \rightarrow N$  be a  $C^1$  map and  $x \in M$  a regular point of  $f$ . Put  $y = f(x)$ . We say  $x$  has *positive type* if the isomorphism  $T_x f: M_x \rightarrow N_y$  preserves orientation, that is, it sends  $\omega_x$  to  $\theta_y$ . In this case we write  $\deg_x f = 1$ . If  $T_x f$  reverses orientation then  $x$  has *negative type*, and we write  $\deg_x f = -1$ . We call  $\deg_x f$  the *degree of  $f$  at  $x$* .

Suppose  $y \in N$  is any regular value for  $f$ . Define the *degree of  $f$  over  $y$*  to be

$$\deg(f, y) = \sum_{x \in f^{-1}(y)} \deg_x f;$$

if  $f^{-1}(y)$  is empty,  $\deg(f, y) = 0$ . To indicate orientations we also write

$$\deg(f, y) = \deg(f, y; \omega, \theta).$$

Reversing  $\omega$  or  $\theta$  changes the sign of  $\deg(f, y)$ .

To interpret  $\deg(f, y)$  geometrically, suppose that  $f^{-1}(y)$  contains  $n$  points of positive type and  $m$  points of negative type, so that  $\deg(f, y) = n - m$ . From the inverse function theorem we can find an open set  $U \subset N$  about  $y$  and an open set  $U(x) \subset M$  about each  $x \in f^{-1}(y)$  such that  $f$  maps each  $U(x)$  diffeomorphically onto  $U$  preserving or reversing orientation according to the type of  $x$ . Thus  $\deg(f, y)$  is the algebraic number of times  $f$  covers  $U$ .

For example, let  $S^1$  be the unit circle in the complex plane. Let  $M = N = S^1$ , and  $\theta = \omega$ . If  $f: S^1 \rightarrow S^1$  is the map  $f(z) = z^n$  then  $\deg(f, z) = n$ , provided  $z \neq 1$  when  $n = 0$ .

If  $M$  is not connected, but has components  $M_1, \dots, M_k$ , note that

$$\deg f = \sum_i \deg(f|_{M_i}).$$

Of course each  $M_j$  is given the orientation  $\omega|_{M_j}$  induced by the inclusion  $M_j \hookrightarrow M$ .

**1.2. Lemma.** *Let  $W$  be a compact oriented manifold of dimension  $n + 1$ ,  $N$  a compact oriented  $n$ -manifold without boundary and  $h: W \rightarrow N$  a  $C^2$  map. Let  $y \in N$  be a regular value for both  $h$  and  $h|_{\partial W}$ . Then  $\deg(h|_{\partial W}, y) = 0$ .*

*Proof.* Let  $\omega, \theta$  be the orientations of  $W, N$  respectively. Let  $M_1, \dots, M_m$  be the components of  $\partial W$ .

Since  $y$  is a regular value,  $h^{-1}(y)$  is a compact 1-dimension submanifold of  $W$  whose boundary is  $(h|_{\partial W})^{-1}(y)$ . Let  $u \in h^{-1}(y)$ . Then there is a unique  $v \in h^{-1}(y)$ ,  $v \neq u$ , and a component arc  $K \subset h^{-1}(y)$  such that  $\partial K = \{u, v\}$ . It suffices to show that  $u$  and  $v$  are of opposite type for  $h|_{\partial W}$ .

Let  $\nu = TW/TK$ , the algebraic normal bundle of  $K$  in  $W$ . Since  $y$  is a regular value,  $Tf$  induces a bimorphism  $\Phi: \nu \rightarrow N_y$ . There are natural identifications  $\nu_u = (\partial W)_u$ ,  $\nu_v = (\partial W)_v$ .

Since  $K$  is an arc there is a unique orientation  $\kappa$  of  $\nu$  such that  $\kappa_u = (\partial\omega)_u$ . By Lemma 1.1,  $\kappa_v = -(\partial\omega)_v$ .

Suppose  $u$  is of positive type (for  $h|_{\partial W}$ ). Then  $\Phi_x(\kappa_x) = \theta_y$  for all  $x \in K$ . It follows that

$$\begin{aligned} T(h|_{\partial W})(\partial\omega)_u &= \Phi_u \kappa_u \\ &= \theta_y, \end{aligned}$$

and

$$\begin{aligned} T(h|_{\partial W})(-\partial\omega)_v &= \Phi_v \kappa_v \\ &= \theta_y. \end{aligned}$$

Therefore  $v$  is of negative type. This shows that  $h|_{\partial W}$  has equal numbers of points of positive and negative type in  $h^{-1}(y)$ .

QED

**1.3. Corollary.** *Let  $(M, \omega)$  and  $(N, \theta)$  be compact, oriented  $n$ -manifolds,  $\partial M = \partial N = \emptyset$ . Let  $N$  be connected, and  $f, g: M \rightarrow N$  homotopic  $C^\infty$  maps having a common regular value  $y \in N$ . Then  $\deg(f, y) = \deg(g, y)$ .*

*Proof.* There is a homotopy  $h: M \times I \rightarrow N$  from  $f$  to  $g$ , and one can make  $h$   $C^\infty$  and transverse to  $y$ . As oriented manifolds

$$\partial(M \times I) = (M \times 0, \omega) \cup (M \times 1, -\omega).$$

By Lemma 1.2 we have

$$\begin{aligned} 0 &= \deg(h|_{\partial(M \times I)}) \\ &= \deg(f, y; \omega, \theta) + \deg(g, y; -\omega, \theta) \\ &= \deg(f, y; \omega, \theta) - \deg(g, y; \omega, \theta). \end{aligned}$$

QED



**1.4. Lemma.** Let  $M, N$  be a compact oriented  $n$ -manifolds without boundaries,  $n \geq 1$ , with  $N$  connected. Let  $y, z \in N$  be regular values for a  $C^\infty$  map  $f: M \rightarrow N$ . Then  $\deg(f, y) = \deg(f, z)$ .

*Proof.* Suppose there is a diffeomorphism  $h: N \rightarrow N$ , homotopic to the identity, such that  $h(y) = z$ . Then  $\deg(h, z) = \deg, h = 1$ , by Corollary 1.3. It is easy to see that this implies

$$\deg(f, y) = \deg(hf, z).$$

But  $hf$  is homotopic to  $f$ ; hence

$$\deg(hf, z) = \deg(f, z).$$

It remains to construct  $h$ . If  $y$  and  $z$  are very close together, say in the same coordinate ball, the construction is not hard, and is left as an exercise. The relation between  $y$  and  $z$ , that such an  $h$  exists, is an equivalence relation on  $N$  whose equivalence classes are thus disjoint open sets. Since  $N$  is connected, any two points are equivalent.

QED

**1.5. Lemma.** Let  $M, N$  be manifolds and  $f: M \rightarrow N$  a continuous map. Then  $f$  can be approximated by  $C^\infty$  maps homotopic to  $f$ .

*Proof.* We may assume, by Theorem 4.6.3, that  $N$  is a  $C^\infty$  retract of an open subset  $W \subset \mathbb{R}_+^n$ ; let  $r: W \rightarrow N$  be a retraction. Let  $g: M \rightarrow N$  be a  $C^\infty$  map which approximates  $f$  so closely that the map

$$\begin{aligned} h: M \times I &\rightarrow \mathbb{R}_+^n, \\ h(x, t) &= (1 - t)f(x) + tg(x) \end{aligned}$$

takes value in  $W$ . Then  $rh: M \times I \rightarrow N$  is a homotopy from  $f$  to  $g$ .

QED

We are ready to define the *degree of a map*. Let  $M, N$  be oriented compact  $n$ -manifolds,  $n \geq 1$ , with  $N$  connected and  $\partial M = \partial N = \emptyset$ . The *degree*  $\deg f$  of a continuous map  $f: M \rightarrow N$  is defined to be  $\deg(g, z)$  where  $g: M \rightarrow N$  is a  $C^\infty$  map homotopic to  $f$  and  $z \in N$  is a regular value for  $g$ . By Lemma 1.5 such a  $g$  exists, and  $\deg f$  is independent of  $g$  and  $z$  by Corollary 1.3 and Lemma 1.4.

If  $M$  and  $N$  are not oriented, perhaps even nonorientable, a *mod 2 degree* of  $f: M \rightarrow N$  is defined as follows. Again let  $z \in N$  be a regular value for a  $C^\infty$  map  $g: M \rightarrow N$  homotopic to  $f$ . Let  $\deg_2(g, z)$  denote the reduction modulo 2 of the number of points in  $g^{-1}(z)$ . Then  $\deg_2(g, z)$  is independent of  $g$  and  $z$ . This follows from the mod 2 analogue of Lemma 1.2, the proof of which reduces to the fact that a compact 1-manifold has an even number of boundary points. We then define  $\deg_2(f) = \deg_2(g, z)$ .

The results proved up to now apply to degrees of continuous maps to

yield:

**1.6. Theorem.** Let  $M, N$  be compact  $n$ -manifolds without boundary, with  $N$  connected.

(a) Homotopic maps  $M \rightarrow N$  have the same degree if  $M, N$  are oriented, and the same mod 2 degree otherwise.

(b) Let  $M = \partial W$ ,  $W$  compact. Suppose a map  $f: M \rightarrow N$  extends to  $W$ . Then  $\deg f = 0$  if  $W$  and  $N$  are orientable, and  $\deg_2 f = 0$  otherwise.

The degree is a powerful tool in studying maps. For example, if  $\deg f$  (or  $\deg_2 f$ ) is nonzero then  $f$  must be surjective. For if  $f$  is not surjective, it can be approximated by a homotopic  $C^\infty$  map  $g$  which is not surjective. If  $y \in N - g(M)$ , clearly  $\deg(g, y) = 0$ .

Here is an application of degree theory to complex analysis; it has the fundamental theorem of algebra as a corollary. Let  $p(z), q(z)$  be complex polynomials. The rational function  $p(z)/q(z)$  extends to a  $C^\infty$  map  $f: S^2 \rightarrow S^2$ , where  $S^2$  denotes the Riemann sphere (the compactification of the complex field  $\mathbb{C}$  by  $\infty$ ). Then:  $f$  is either constant or surjective.

The key to the proof is the observation that  $z \in S^2$  is a regular point if and only if the complex derivative  $f'(z) \neq 0$ , and in this case the real derivative  $Df_z: \mathbb{R}^2 \rightarrow \mathbb{R}^2$  has positive determinant.

If  $f$  is not constant then  $f'$  is not identically 0; hence there is a regular point  $z$ . By the inverse function theorem there is an open set  $U \subset S^2$  about  $z$ , containing only regular points, such that  $f(U)$  is open. Let  $w \in f(U)$  be a regular value. Then  $f^{-1}(w)$  is nonempty. Since every point in  $f^{-1}(w)$  has positive type, it follows that  $\deg(f, w) = \deg f > 0$ . Therefore  $f$  is surjective.

A famous application of degree theory is the so-called "hairy ball theorem": every vector field on  $S^{2n}$  is zero somewhere; more picturesquely, a hairy ball cannot be combed. To prove this, suppose that  $\sigma$  is a vector field on  $S^k$  which is nowhere zero. A homotopy of  $S^k$  from the identity to the antipodal map is obtained by moving each  $x \in S^k$  to  $-x$  along the great semicircle in the direction  $\sigma(x)$ . The existence of such a homotopy implies that the antipodal map has degree  $+1$  and so preserves orientation; therefore  $k$  is odd.

The question of zeros of a vector field, or more generally, of a section of a vector bundle, is approached more systematically in Section 5.2 with the theory of Euler numbers.

The following lemma will be used in the extension Theorem 1.8.

**1.7. Lemma.** Let  $W$  be an oriented  $(n + 1)$ -manifold and  $K \subset W$  a neat arc. Let  $V \subset \partial W$  be a neighborhood of  $\partial K$  and  $f: V \rightarrow N$  a map to an oriented  $n$ -manifold  $N$ ,  $\partial N = \emptyset$ . Let  $y \in N$  be a regular value of  $f$  and assume  $\partial K = f^{-1}(y)$ . Finally, assume that  $f$  has opposite degrees at the two endpoints of  $K$ . Then there is a neighborhood  $W_0 \subset W$  of  $K$  and a map  $g: W_0 \rightarrow N$  such that:

- (a)  $g = f$  on  $W_0 \cap V$ ,
- (b)  $y$  is a regular value of  $g$ ,
- (c)  $g^{-1}(y) = K$ .

*Proof.* We may take  $(N, y) = (\mathbb{R}^n, 0)$ . Let the endpoints of  $K$  be  $x_0, x_1$ . Since 0 is a regular value each  $x_i$  has a neighborhood  $U_i \subset V$  such that  $f$  restricts to an embedding  $f_i: (U, x_i) \rightarrow (\mathbb{R}^n, 0)$ .

It suffices to prove the lemma for any map agreeing with  $f$  near  $K$ . Therefore we can assume that each  $f_i$  is a diffeomorphism. Then  $f_i^{-1}$  can be regarded as a tubular neighborhood of  $x_i$  in  $W$ ; and together,  $f_0^{-1}$  and  $f_1^{-1}$  form a tubular neighborhood of  $\partial K$  in  $\partial W$ .

By Theorem 4.6.4 this tubular neighborhood extends to a tubular neighborhood  $E$  of  $K$  in  $V$ . We may assume  $W = E$ . Since  $K$  is an arc,  $E$  is a trivial vector bundle over  $K$ , and we may assume that

$$(W, K) = (I \times \mathbb{R}^n, I \times 0)$$

and  $(N, y) = (\mathbb{R}^n, 0)$ . With this notation,

$$V = 0 \times \mathbb{R}^n \cup 1 \times \mathbb{R}^n$$

and  $f_i: i \times \mathbb{R}^n \rightarrow \mathbb{R}^n$  ( $i = 0, 1$ ) is given by a linear isomorphism  $L_i \in GL(n)$ . The degree assumptions and the convention for orienting  $\partial(I \times \mathbb{R}^n)$  mean that  $L_0$  and  $L_1$  have determinants of the same sign. Therefore  $L_0$  and  $L_1$  can be joined by a path  $L_t$  in  $GL(n)$ ,  $0 \leq t \leq 1$ . The required extension of  $f$  is the map

$$I \times \mathbb{R}^n \rightarrow \mathbb{R}^n, \\ (t, y) \mapsto L_t(y).$$

QED

We can now prove a basic extension theorem:

**1.8. Theorem.** *Let  $W$  be a connected oriented compact  $\partial$ -manifold of dimension  $n + 1$ . Let  $f: \partial W \rightarrow S^n$  be a continuous map. Then  $f$  extends to a map  $W \rightarrow S^n$  if and only if  $\deg f = 0$ .*

*Proof.* We already know that the degree vanishes if  $f$  extends. Suppose then that  $\deg f = 0$ .

By homotopy extension it suffices to extend some map homotopic to  $f$ . Since  $f$  is homotopic to a  $C^\infty$  map (Theorem 1.5) we may assume  $f$  is  $C^\infty$ . Let  $y \in S^n$  be a regular value of  $f$ .

Since  $\deg(f, y) = 0$ ,  $f^{-1}(y)$  has equal numbers of points of positive and negative type. We can find a set of disjoint embedded arcs  $K_1, \dots, K_m \subset W$ , each going from a positive to a negative point of  $f^{-1}(y)$ , with  $K = K_1 \cup \dots \cup K_m$  a neat submanifold and  $\partial K = f^{-1}(y)$ . When  $\dim W \geq 3$  this follows from density of embeddings  $I \rightarrow W$ . When  $\dim W = 2$  we can find immersed arcs  $K_1, \dots, K_m$  (which may cross each other). A new family of  $K'_1, \dots, K'_m$  without crossings can be obtained by the following device. Assume the crossings are in general position. At each crossing make the change suggested by Figure 5-1. The arrows indicate the orientation of the arcs from positive to negative endpoint. There results a compact neat 1-dimensional submanifold  $K'$  of  $W$  with boundary  $f^{-1}(y)$ . Each component

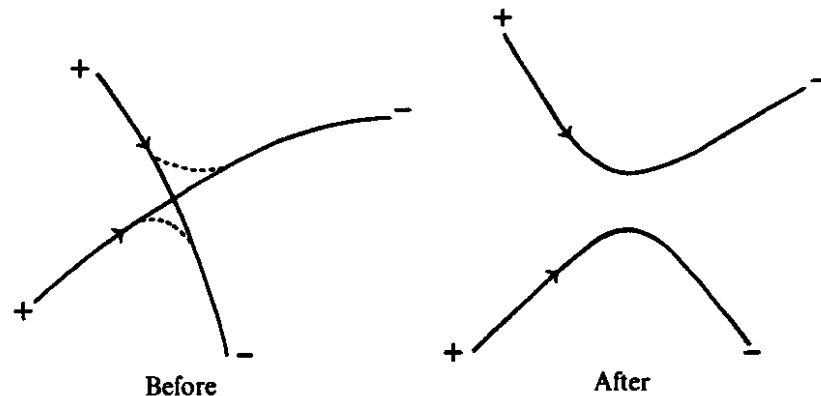

Figure 5-1. Eliminating crossings.

of  $K'$  is an arc or a circle; each arc has endpoints of opposite types (see the arrows in Figure 5-1). Thus we obtain disjoint embedded arcs.

Now apply Lemma 1.7 to each arc  $K_i$ , with  $N = S^n$ . We obtain an open neighborhood  $W_0 \subset W$  of  $\cup K_i$  and a map  $g: W_0 \rightarrow S^n$  which agrees with  $f$  on  $\partial W_0$ , having  $y$  as a regular value, and with  $g^{-1}(y) = \cup K_i$ .

Let  $U \subset W_0$  be a smaller open neighborhood of  $\cup K_i$  whose closure is in  $W_0$ . Then  $\text{Bd } U \subset W_0 - \cup K_i$ . The maps  $g$  and  $f$  fit together to form a continuous map

$$h: X = \text{Bd } U \cup (\partial W - U) \rightarrow S^n - y.$$

Note that  $X$  is a closed subset of  $W - U$ . Since  $S^n - y \approx \mathbb{R}^n$ , Tietze's extension theorem permits an extension of  $h$  to a map  $H: W - U \rightarrow S^n - y$ . An extension of  $f$  to  $W$  is the map equal to  $H$  on  $W - U$  and to  $g$  on  $W_0$ .

QED

An analogue of Theorem 1.8 for nonorientable manifolds is:

**1.9. Theorem.** *Let  $W$  be a connected compact nonorientable  $\partial$ -manifold of dimension  $n + 1 \geq 2$ . A map  $f: \partial W \rightarrow S^n$  extends to  $W$  if and only if  $\deg_2 f = 0$ .*

*Proof.* If  $f$  extends,  $\deg_2 f = 0$  by Theorem 1.6.

Suppose  $\deg_2 f = 0$ . We may assume  $f$  is  $C^\infty$ . Consider first the case  $\dim W \geq 3$ .

Let  $y \in S^n$  be a regular value; then  $f^{-1}(y)$  has even cardinality. Hence  $f^{-1}(y) = \partial K$  where  $K \subset W$  is the union of disjoint neatly embedded arcs.

Let  $K_i$  be one of these arcs with endpoints  $u, v \in f^{-1}(y)$ . Although  $TW$  is not an orientable vector bundle,  $TW|_{K_i}$  is. Give  $TW|_{K_i}$  an arbitrary orientation; this induces orientations to  $T_u \partial W$  and  $T_v \partial W$ . It then makes sense to ask whether  $u$  and  $v$  are of opposite type for the map  $f$ . If they are

not, we change  $K_i$  to a new arc  $K'_i$  by adding to it an orientation reversing loop  $L$  in  $W$  (see Figure 5-2).

Because  $\dim W \geq 3$  we can make  $K'_i$  embedded and disjoint from the other arcs  $K_j$ . Give  $TW|_{K'_i}$  an orientation and give  $T_u\partial W$  and  $T_v\partial W$  the induced orientations. With respect to these orientations,  $u$  and  $v$  are now of opposite type; otherwise  $L$  would preserve orientation.

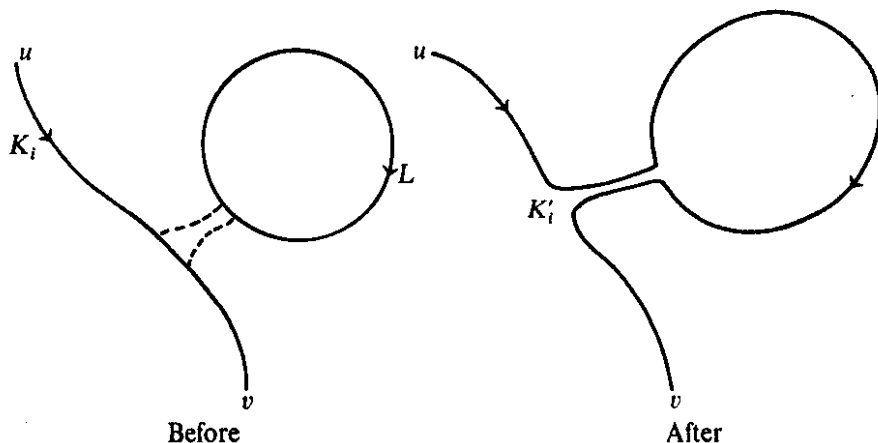

Figure 5-2.

We can thus assume that  $T_K W$  is oriented so that with respect to the induced orientation of  $T(\partial W)|_{f^{-1}(y)}$ , the endpoints of each arc are of opposite type. The rest of the proof for  $\dim W \geq 3$  is now exactly like that for the oriented case.

Now let  $\dim W = 2$ . Let  $y \in S^1$  be a regular value for  $f$ . After a homotopy, we may assume that there are disjoint open intervals  $I_1, \dots, I_\nu \subset \partial W$  with the following properties:

- each  $I_j$  contains exactly one point  $x_j$  of  $f^{-1}(y)$ ;
- $f$  maps  $I_j$  diffeomorphically onto  $S^1 - (-y)$ ;
- $f(\partial W - \cup I_j) = -y$ .

We say that  $f$  is in *standard form* in this case.

Give  $\partial W$  any orientation, so that the integer  $\deg f$  is now defined. Note that  $\deg f$  is even. Each  $I_j$  contributes  $\pm 1$  to  $\deg f$ ; hence  $\nu$  is even.

We proceed by induction on  $\nu = \nu(f)$ ; if  $\nu = 0$  then  $f$  is constant and extends to the constant map of  $W$ . Suppose then that  $\nu \geq 2$ .

Let  $K \subset W$  be a neat arc joining  $x_1$  to  $x_2$ ; give  $T_K W$  an orientation  $\omega$ . As before, choose  $K$  so that  $x_1$  and  $x_2$  are of opposite type for  $f$  with respect to the orientations of  $T_{x_i}\partial W$ ,  $i = 1, 2$  induced by  $\omega$ .

Let  $N \subset W$  be a tubular neighborhood of  $K$  such that  $N \cap \partial W = I_1 \cup I_2$ . Topologically  $N$  is a rectangle whose boundary  $\partial N$  is a circle consisting of four arcs  $I_1, J_1, I_2, J_2$ .

We change  $f$  to a new map  $g: \partial W \rightarrow S^1$  thus:  $g = f$  on  $\partial W - (I_1 \cup I_2)$ , while  $g(I_1 \cup I_2) = -y$ . Observe that  $g$  is in standard form and  $\nu(g) = \nu(f) - 2$ . We assume inductively that  $g$  extends to a map  $G: W \rightarrow S^1$ .

Note that  $\deg(G|\partial N) = 0$ , by Theorem 1.6(b) since  $G$  extends over  $N$ . Since  $G|_{I_1 \cup I_2}$  is constant, this means that  $\deg G|_{J_1} + \deg G|_{J_2} = 0$ , when  $J_1$  and  $J_2$  are given orientations induced from an orientation of  $\partial N$ .

Define a new map  $h: \partial N \rightarrow S^1$  equal to  $G$  on  $J_1 \cup J_2$  and to  $f$  on  $I_1 \cup I_2$ . Because of the way the arc  $K$  was chosen,  $\deg f|_{I_1} + \deg f|_{I_2} = 0$ . It follows that  $\deg h = 0$ . By Theorem 1.8 (adapted to  $N$ ) there is an extension of  $h$  to a map  $H: N \rightarrow S^1$ . The required extension of  $f$  is the map  $W \rightarrow S^1$  which equals  $H$  on  $N$  and  $G$  on  $W - N$ .

QED

We can now classify maps of all compact  $n$ -manifolds into  $S^n$ . Let  $\simeq$  denote the relation of homotopy.

**1.10. Theorem.** Let  $M$  be a compact connected  $n$ -manifold,  $n \geq 1$ . Let  $f, g: M \rightarrow S^n$  be continuous maps.

(a) If  $M$  is oriented and  $\partial M = \emptyset$ , then  $f \simeq g$  if and only if  $\deg f = \deg g$ ; and there are maps of every degree  $m \in \mathbb{Z}$ .

(b) If  $M$  is nonorientable and  $\partial M = \emptyset$ , then  $f \simeq g$  if and only if  $\deg_2 f = \deg_2 g$ ; and there are maps of every degree  $m \in \mathbb{Z}_2$ .

(c) If  $\partial M \neq \emptyset$  then  $f \simeq g$ .

*Proof.* We first show that there are maps of every degree. Let  $M$  be as in (a). The constant map  $M \rightarrow S^n$  has degree 0. Given  $m \in \mathbb{Z}_+$  let  $\varphi_i: U_i \rightarrow \mathbb{R}^n$ ,  $i = 1, \dots, m$  be disjoint surjective charts which preserve orientation. Let  $s: \mathbb{R}^n \rightarrow S^n - P$  be the inverse of stereographic projection from the north pole  $P$  so that  $s$  preserves orientation. Define

$$f: M \rightarrow S^n, \\ f = \begin{cases} s\varphi_i & \text{on } U_i \\ \text{constant map } P & \text{on } M - \cup U_i. \end{cases}$$

Then  $f$  is continuous and has degree  $m$ . If the  $\varphi_i$  were orientation reversing  $f$  would have degree  $-m$ . Taking  $m = 1$  and ignoring orientations proves the second part of (b).

The first parts of (a) and (b) are consequences of Theorems 1.8 and 1.9 with  $W = M \times I$ . To prove (c) let  $M'$  be the double of  $M$ , two copies of  $M$  glued along  $\partial M$ , and  $p: M' \rightarrow M$  the map identifying the two copies, and  $i: M \rightarrow M'$  the embedding of one copy. It is easy to see that  $fp: M' \rightarrow S^n$  has degree 0 if  $M$  is orientable, and otherwise  $\deg_2(fp) = 0$ . Therefore  $fp$  is homotopic to a constant map  $c$  (which also has degree 0). Since  $fpi = f$ , it follows that  $f \simeq c$ . Similarly  $g \simeq c$ , so  $f \simeq g$ .

QED

## Exercises

1. A complex polynomial of degree  $n$  defines a map of the Riemann sphere to itself of degree  $n$ . What is the degree of the map defined by a rational function  $p(z)/q(z)$ ?

2. (a) Let  $M, N, P$  be compact connected oriented  $n$ -manifolds without boundaries and  $M \xrightarrow{g} N \xrightarrow{f} P$  continuous maps. Then  $\deg(fg) = (\deg g)(\deg f)$ . The same holds mod 2 if  $M, N, P$  are not oriented.

(b) The degree of a homeomorphism or homotopy equivalence is  $\pm 1$ .

\*3. Let  $\mathfrak{M}_n$  be the category whose objects are compact connected  $n$ -manifolds and whose morphisms are homotopy classes  $[f]$  of maps  $f: M \rightarrow N$ . For an object  $M$  let  $\pi^*(M)$  be the set of homotopy classes  $M \rightarrow S^n$ . Given  $[f]: M \rightarrow N$  define  $[f]^*: \pi^*(N) \rightarrow \pi^*(M)$ ,  $[f]^*[g] = [gf]$ . This makes  $\pi^*$  a contravariant functor from  $\mathfrak{M}_n$  to the category of sets.

(a) There is a unique way of lifting this functor to the category of groups so that  $\pi^*(S^n) = \mathbb{Z}$  with the identity map corresponding to  $1 \in \mathbb{Z}$ .

(b) Given the group structure of (a), for each  $M$  there is an isomorphism

$$\pi^*(M) \approx \begin{cases} \mathbb{Z} & \text{if } M \text{ is orientable, } \partial M = \emptyset \\ \mathbb{Z}_2 & \text{if } M \text{ is nonorientable, } \partial M = \emptyset \\ 0 & \text{if } \partial M \neq \emptyset. \end{cases}$$

But there is no natural family of such isomorphisms.

4. A continuous map  $f: S^n \rightarrow S^n$  such that  $f(x) = f(-x)$  has even degree.

\*5. Let  $M, N$  be compact connected oriented  $n$ -manifolds,  $\partial M = \emptyset$ .

(a) Suppose  $n \geq 2$ . If there exists a map  $S^n \rightarrow M$  of degree one, then  $M$  is simply connected. More generally:

(b) If  $f: M \rightarrow N$  has degree 1 then the induced homomorphism of fundamental groups  $f_*: \pi_1(M) \rightarrow \pi_1(N)$  is surjective.

(c) If  $f: M \rightarrow N$  has degree  $k \neq 0$  then the image of  $f_*$  is a subgroup whose index divides  $|k|$ .

6. Let  $M \subset \mathbb{R}^{n+1}$  be a compact  $n$ -dimensional submanifold,  $\partial M = \emptyset$ . For each  $x \in \mathbb{R}^{n+1} - M$  define

$$\sigma_x: M \rightarrow S^n, \quad y \mapsto (y - x)/|y - x|.$$

Then  $x$  and  $y$  are in the same component of  $\mathbb{R}^{n+1} - M$  if and only if  $\sigma_x \simeq \sigma_y$ , and  $x$  is in the unbounded component if and only if  $\sigma_x \simeq \text{constant}$ . If  $M$  is connected then  $x$  is in the bounded component if and only if  $\deg(\sigma_x) = \pm 1$ .

7. Let  $M, N \subset \mathbb{R}^q$  be compact oriented submanifolds without boundaries, of dimensions  $m, n$  respectively. Assume that  $M$  and  $N$  are disjoint, and  $m + n = q - 1$ . The linking number  $\text{Lk}(M, N)$  is the degree of the map

$$\begin{aligned} M \times N &\rightarrow S^{q-1} \\ (x, y) &\mapsto (x - y)/|x - y|. \end{aligned}$$

Then:

(a)  $\text{Lk}(M, N) = (-1)^{(m-1)(n-1)} \text{Lk}(N, M)$ .

(b) If  $M$  can be deformed to a point in  $\mathbb{R}^q - N$ , or bounds an oriented compact submanifold in  $\mathbb{R}^q - N$ , then  $\text{Lk}(M, N) = 0$ .

(c) Let  $S, S'$  be the boundary circles of a cylinder embedded in  $\mathbb{R}^3$  with  $k$  twists. Then, with suitable orientations,  $\text{Lk}(S, S') = k$ .

(d) Let  $C_1$  and  $C_2 \subset \mathbb{R}^3$  be cylinders embedded with  $k_1$  and  $k_2$  twists respectively. If  $|k_1| \neq |k_2|$  there is no diffeomorphism of  $\mathbb{R}^3$  carrying  $C_1$  onto  $C_2$ .

8. Let  $M \subset \mathbb{R}^{n+1}$  be a compact  $n$ -dimensional submanifold without boundary. Two points  $x, y \in \mathbb{R}^{n+1} - M$  are separated by  $M$  if and only if  $\text{Lk}(\{x, y\}, M) \neq 0$ . (See Exercise 7.)

9. The Hopf invariant of a map  $f: S^3 \rightarrow S^2$  is defined to be the linking number  $H(f) = \text{Lk}(g^{-1}(a), g^{-1}(b))$  (see Exercise 7) where  $g$  is a  $C^\infty$  map homotopic to  $f$  and  $a, b$  are distinct regular values of  $g$ . The linking number is computed in

$$\mathbb{R}^3 = S^3 - c, \quad f(c) \neq a, b.$$

(a)  $H(f)$  is a well-defined homotopy invariant of  $f$  which vanishes if  $f$  is null homotopic.

(b) If  $g: S^3 \rightarrow S^3$  has degree  $p$  then  $H(fg) = pH(f)$ .

(c) If  $h: S^2 \rightarrow S^2$  has degree  $q$  then  $H(hf) = q^2H(f)$ .

(d) Let  $S^3 \subset \mathbb{C}^2$  be the unit sphere and  $S^2 = \mathbb{C}P^1$ . The Hopf map

$$\begin{aligned} \varphi: S^3 &\rightarrow S^2, \\ \varphi(z, w) &= [z, w] \end{aligned}$$

has Hopf invariant 1. Hence  $\varphi$  is not null homotopic.

10. Let  $U, V$  be noncompact oriented  $n$ -manifolds without boundaries and  $h: U \rightarrow V$  a proper  $C^\infty$  map. The degree of  $h$  is defined as usual,

$$\deg h = \sum_x \deg_x h \quad (x \in h^{-1}(y))$$

where  $y$  is a regular value.

(a)  $\deg h$  is independent of  $y$ , and if  $g$  is a  $C^\infty$  map homotopic to  $h$  by a proper homotopy  $U \times I \rightarrow V$  then  $\deg g = \deg h$ . Thus the degree of any continuous proper map  $f: U \rightarrow V$  can be defined by choosing  $h$  sufficiently close to  $f$ .

(b) In particular the degree of a homeomorphism  $U \rightarrow V$  is defined; it is always  $\pm 1$ . (Compare Exercise 2).

(c) A topological  $n$ -manifold without boundary is called *topologically orientable* if it has an atlas whose coordinate changes have degree  $+1$  on each component. A smooth manifold is orientable if and only if it is topologically orientable.

(d) Orientability of a smooth manifold is a topological invariant.

11. The fundamental theorem of algebra can be generalized as follows. Let  $U \subset \mathbb{R}^n$  be a nonempty open set and  $f: U \rightarrow \mathbb{R}^n$  a  $C^1$  map. Assume: (a)  $f$  is proper; (b) outside some compact set,  $\text{Det}(Df_x) > 0$ . Then  $f$  is surjective. In particular the equation  $f(x) = 0$  has a solution.

12. Let  $f_1, \dots, f_n$  be real [or complex] polynomials in  $n \geq 2$  variables. Write  $f_k = h_k + r_k$  where  $h_k$  is a homogeneous polynomial of degree  $d_k > 0$  and  $r_k$  has smaller degree. Assume that  $x = (0, \dots, 0)$  is the only solution to  $h_1(x) = \dots = h_n(x) = 0$ . Assume also that  $\text{Det}[\partial h_i / \partial x_j] \neq 0$  at all nonzero  $x$  in  $\mathbb{R}^n$  [or  $\mathbb{C}^n$ ]. Then the system of equations  $f_k(x) = 0, k = 1, \dots, n$ , has a solution in  $\mathbb{R}^n$  [or  $\mathbb{C}^n$ ]. [Hint: Exercise 11.]

## 2. Intersection Numbers and the Euler Characteristic

Let  $W$  be an oriented manifold of dimension  $m + n$  and  $N \subset W$  a closed oriented submanifold of dimension  $n$ . Let  $M$  be a compact oriented  $m$ -manifold. Suppose  $\partial M = \partial N = \emptyset$ .

Let  $f: M \rightarrow W$  be a  $C^\infty$  map transverse to  $N$ .

A point  $x \in f^{-1}(N)$  has *positive or negative type* according as the composite linear isomorphism

$$M_x \xrightarrow{Tf} W_y \rightarrow W_y/N_y, \quad y = f(x)$$

preserves or reverses orientation; we write  $\#_x(f, N) = 1$  or  $-1$ , respectively. The *intersection number* of  $(f, N)$  is the integer

$$\#(f, N) = \sum \#_x(f, N),$$

summed over all  $x \in f^{-1}(N)$ .

**2.1. Theorem.** *If  $f, g: M \rightarrow W$  are homotopic  $C^\infty$  maps transverse to  $N$  then  $\#(f, N) = \#(g, N)$ .*

*Proof.* The proof is similar to that of Corollary 1.3 and is left to the reader.

QED

For any continuous map  $g: M \rightarrow W$  we define  $\#(g, N) = \#(f, N)$  where  $f$  is a  $C^\infty$  map which is transverse to  $N$  and homotopic to  $g$ . By Theorem 2.1,  $\#(g, N)$  is well defined.

Note that it is not really necessary for  $N$  and  $W$  to be oriented; all that is actually used is an orientation of the normal bundle of  $N$ .

If  $M$  is also a submanifold of  $W$  and  $i: M \rightarrow W$  is the inclusion, the *intersection number* of  $(M, N)$  is the integer  $\#(M, N) = \#(i, N)$ . We put  $\#(M, N) = \#(M, N; W)$  to emphasize  $W$ . If both  $M$  and  $N$  are compact then  $\#(M, N) = (-1)^{mn} \#(N, M)$  as is easily proved.

Clearly  $\#(f, N) = 0$  if  $f$  is homotopic in  $W$  to  $g: M \rightarrow W - N$ . In particular if  $M$  and  $N$  are closed submanifolds of  $\mathbb{R}^{m+n}$  with  $M$  compact and  $\partial M = \partial N = \emptyset$ , then  $\#(M, N; \mathbb{R}^{m+n}) = 0$ .

It is not generally true that if  $\#(M, N) = 0$  then  $M$  is deformable into  $W - N$ ; Figure 5-3 shows a counterexample of two circles on a surface  $S$  of genus 2. If  $M, N$ , and  $W$  are allowed to have boundaries,  $\#(f, N)$  and  $\#(M, N)$  are defined in the same way whenever  $M$  is a neat submanifold and  $f(\partial M) \subset \partial W - \partial N$ . In this case the  $C^\infty$  map  $g: M \rightarrow W$  must be homotopic

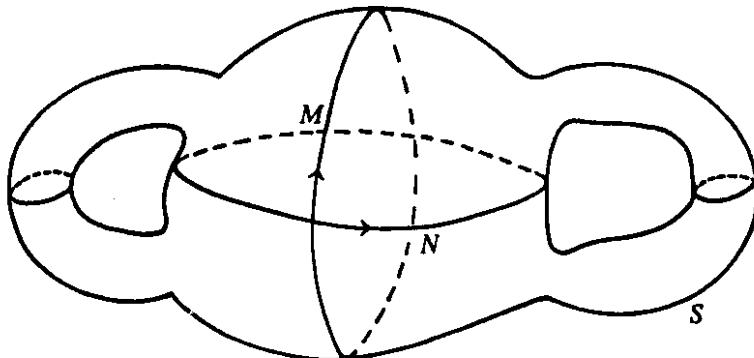

Figure 5-3.  $\#(M, N) = 0$ , but  $M$  is not deformable into  $S - N$ .

to  $f$  by a homotopy that takes  $\partial M$  into  $\partial W - \partial N$  at each stage. Of course  $\#(f, N)$  is only an invariant of this kind of homotopy.

If  $M, N$  or  $W$  is not oriented, mod 2 intersection numbers  $\#_2(f, N)$  and  $\#_2(M, N)$  are defined in a similar way.

Let  $\xi = (p, E, M)$  be an  $n$ -dimensional oriented vector bundle over  $M$ ; as usual  $M$  is identified with the zero section. Assume  $M$  is connected, oriented, compact,  $n$ -dimensional and without boundary. The *Euler number* of  $\xi$  is defined to be the integer

$$X(\xi) = \#(M, M) = \#(M, M; E)$$

**2.2. Theorem.** *If  $\xi$  (as above) has a section  $f$  that is nowhere zero then  $X(\xi) = 0$ .*

*Proof.*  $f$  is homotopic to the zero section by the linear homotopy  $(x, t) \rightarrow tf(x)$ . Hence if  $i: M \rightarrow E$  is the zero section,

$$X(\xi) = \#(i, M) = \#(f, M) = 0.$$

QED

To compute  $X(\xi)$  approximate the zero section  $Z: M \rightarrow E$  by a  $C^\infty$  map  $h$  transverse to  $Z(M)$ . If the approximation is close enough then  $ph: M \rightarrow M$  is a diffeomorphism and we obtain a  $C^\infty$  section  $g$  transverse to the zero section by setting  $g = h(ph)^{-1}$ ; thus  $fg = 1_M$ .

Let  $x_1, \dots, x_m \in M$  be the zeros of  $g$ . Let  $\varphi_i: \xi|_{U_i} \rightarrow U_i \times \mathbb{R}^n$  be local trivializations of  $\xi$  over open sets  $U_i \subset M$  such that  $x_i \in U_i$ . The composition

$$F_i: U_i \xrightarrow{g} E|_{U_i} \rightarrow U_i \times \mathbb{R}^n \rightarrow \mathbb{R}^n$$

has  $0 \in \mathbb{R}^n$  as a regular value and  $x_i \in F_i^{-1}(0)$ . Then

$$\deg_{x_i} F_i = \#_{x_i}(g, M),$$

called the *index of  $g$  at  $x_i$* . Hence

$$X(\xi) = \sum_i \deg_{x_i} F_i.$$

If  $\xi = TM$  with the same orientation as  $M$  then  $X(\xi)$  is called the *Euler characteristic* of  $M$ , denoted by  $\chi(M)$ . Later we shall define  $\chi(M)$  for non-orientable and  $\partial$ -manifolds.

A section of  $TM$  is called a *vector field* on  $M$ .

To compute  $\chi(M)$  one can start with a  $C^\infty$  vector field  $f: M \rightarrow TM$  transverse to the zero section. At each zero  $x_i$  of  $f$  let  $\varphi_i: U_i \rightarrow \mathbb{R}^n$  be a chart (preserving orientation). Then  $T\varphi_i \circ f \circ \varphi_i^{-1}$  is a  $C^\infty$  vector field on  $\varphi_i(U_i)$  and thus defines a  $C^\infty$  map  $g_i: \varphi_i(U_i) \rightarrow \mathbb{R}^n$  with a regular value at 0. Denote by  $d_i$  the degree of  $g_i$  at  $\varphi_i(x_i)$ ; then  $\chi(M) = \sum d_i$ . The integer  $d_i$  is the *index at  $x_i$  of the vector field  $f$* ; it is independent the choice of  $(\varphi_i, U_i)$  and the orientation of  $M$ . We denote  $d_i$  by  $\text{Ind}_{x_i} f$ .

As an example we compute  $\chi(S^n)$ . Let  $P$  be the north pole and  $Q = -P$  the south pole. Let

$$\begin{aligned} \sigma: S^n - P &\rightarrow \mathbb{R}^n \\ \tau: S^n - Q &\rightarrow \mathbb{R}^n \end{aligned}$$

be the stereographic projections. The coordinate change

$$\tau\sigma^{-1} = \sigma\tau^{-1}: \mathbb{R}^n - 0 \rightarrow \mathbb{R}^n - 0$$

is given by  $x \mapsto x/|x|^2$ .

Let  $f$  be the vector field on  $S^n - P$  whose representation via  $\sigma$  is the identity vector field on  $\mathbb{R}^n$ . Then  $f(x) \rightarrow 0$  as  $x \rightarrow P$  and we define  $f(P) = 0$ . Thus  $f: S^n \rightarrow TS^n$  has zeroes only at  $Q$  and  $P$ .

In  $\tau$  coordinates  $f$  corresponds to the vector field  $x \mapsto -x$  on  $S^n - Q$ . Thus  $f$  is  $C^\infty$ .

The identity map of  $\mathbb{R}^n$  has degree 1 at 0, the antipodal map has degree  $(-1)^n$ . Therefore

$$\text{Ind}_P f = 1, \quad \text{Ind}_Q f = (-1)^n.$$

Thus we have proved:

**2.3. Theorem.**

$$\chi(S^n) = 1 + (-1)^n = \begin{cases} 2 & \text{if } n \text{ is even,} \\ 0 & \text{if } n \text{ is odd.} \end{cases}$$

**2.4. Corollary.** Every vector field on  $S^{2n}$  vanishes somewhere.

Some other computations are given by:

**2.5. Theorem.** (a) Let  $M$  and  $N$  be compact oriented manifolds without boundaries. Then  $\chi(M \times N) = \chi(M)\chi(N)$ .

(b) Let  $\xi$  be an  $n$ -dimensional oriented vector bundle over a compact oriented  $n$ -manifold  $M^n$  without boundary. Then  $X(\xi) = 0$  if  $n$  is odd.

(c)  $\chi(M) = 0$  if  $M$  is an odd dimensional compact oriented manifold without boundary.

*Proof.* (a) is proved by choosing vector fields  $f, g$  on  $M, N$  and using  $f \times g: M \times N \rightarrow TM \times TN$  to compute  $\chi(M \times N)$ . The details are left as an exercise.

(b) is proved by using sections  $f$  and  $-f$  to compute  $X(\xi)$  in two ways. One finds that

$$\text{Ind}_x f = (-1)^n \text{Ind}_x(-f), \quad n = \dim M.$$

Hence if  $n$  is odd,  $X(\xi) = -X(\xi)$ . And (c) follows from (b).

QED

Now we define  $\chi(M)$  for a nonorientable compact manifold  $M, \partial M = \emptyset$ . Let  $f: M \rightarrow TM$  be a section transverse to  $M$ . For each  $x \in M$  there is

a canonical identification

$$(TM)_x/M_x \approx M_x;$$

see Theorem 4.2.1. Therefore  $Tf$  induces an automorphism  $\Phi_x$  via the composition

$$\Phi_x: M_x \xrightarrow{Tf} (TM)_x \rightarrow (TM)_x/M_x \approx M_x.$$

Define

$$\begin{aligned} \text{Ind}_x f &= \text{Det } \Phi_x / |\text{Det } \Phi_x|, \\ \chi_f(M) &= \sum \text{Ind}_x f, \quad x \in f^{-1}(M). \end{aligned}$$

This definition of course makes sense if  $M$  is oriented, and in that case it is easy to check that it is the same as  $\chi(M)$ . In particular, it is independent of  $f$  and of the orientation in this case.

For  $M$  nonorientable, let  $p: \tilde{M} \rightarrow M$  be the oriented double covering. Given  $f$  as above let  $\tilde{f}: \tilde{M} \rightarrow T\tilde{M}$  be the unique section covering  $f$ . Let  $\tilde{x} \in \tilde{f}^{-1}(\tilde{M})$ ; put  $p(\tilde{x}) = x$ . It is clear that

$$\text{Ind}_{\tilde{x}} \tilde{f} = \text{Ind}_x f.$$

It follows that

$$\chi_f(\tilde{M}) = 2\chi_f(M),$$

or

$$\frac{1}{2}\chi(\tilde{M}) = \chi_f(M).$$

Thus  $\chi_f(M)$  is independent of  $f$ .

Parts (a) and (c) of Theorem 2.5 hold for  $M$  nonorientable.

The Euler characteristic  $\chi(M)$  of a compact  $\partial$ -manifold  $M$  is defined as follows. Let  $f: M \rightarrow TM$  be a section which is transverse to the zero section  $M$ , and such that  $f$  points outward at points of  $\partial M$ . Such a section always exists; for example, an outward section over  $\partial M$  can be obtained from a collar, extended over  $M$  by a partition of unity, and then be made transverse to the zero section by approximation. Moreover any two such outward vector fields are connected by a homotopy of outward vector fields. We define

$$\chi(M) = \chi_f(M) = \sum_x \text{Ind}_x f, \quad x \in f^{-1}(M).$$

To show that  $\chi_f(M)$  is independent of  $f$ , let  $\tilde{M} \rightarrow M$  be the oriented double covering of  $M$  and let  $\tilde{f}$  be the vector field on  $\tilde{M}$  which covers  $f$ . Then  $\tilde{f}$  is outward, and local computations show that  $\chi_f(\tilde{M}) = 2\chi_f(M)$ . It therefore suffices to show that  $\chi_f(M)$  is independent of  $f$  when  $M$  is oriented; and this proof is similar to that of Theorem 1.2.

The Euler characteristic  $\chi(M)$  is thus defined for any compact manifold  $M$ . Note that Theorem 2.5 (a) is true whenever  $\partial M$  or  $\partial N$  is empty.

The proof of the following lemma is left to the reader (a similar argument was given in the proof of Theorem 1.4).

**2.6. Lemma.** Let  $M$  be a connected manifold,  $U \subset M$  an open set  $F \subset M$  a finite set. Then there is a diffeomorphism of  $M$  carrying  $F$  into  $U$ .

Using the lemma we prove:

**2.7. Theorem.** *Let  $M$  be a compact connected  $\partial$ -manifold. Then  $M$  has a nonvanishing vector field.*

*Proof.* Let  $M'$  be the double of  $M$ , containing  $M$  as a submanifold. Then  $M'$  has a vector field  $f$  with a finite set  $F$  of zeros. Let  $\varphi: M' \rightarrow M'$  be a diffeomorphism taking  $F$  into  $M' - M$ . Then  $T\varphi \circ f \circ \varphi^{-1}|_M$  is a vector field on  $M$  without zeros!

QED

The following lemma relates the index of a zero of a vector field to the degree of a map into a sphere.

**2.8. Lemma.** *Let  $D \subset \mathbb{R}^n$  be an  $n$ -disk with center  $x$ . Let  $U \subset \mathbb{R}^n$  be an open set containing  $D$  and  $f: U \rightarrow \mathbb{R}^n$  a  $C^\infty$  map, considered as a vector field on  $U$ . Suppose  $0$  is a regular value and  $x = D \cap f^{-1}(0)$ . Define a map*

$$g: \partial D \rightarrow S^{n-1},$$

$$y \rightarrow f(y)/|f(y)|.$$

Then  $\text{deg } g = \text{Ind}_x f$ .

*Proof.* We may suppose for simplicity that  $x = 0$ . Define  $f_t: U \rightarrow \mathbb{R}^n$  by:

$$f_t(y) = \begin{cases} t^{-1}f(ty), & 1 \geq t > 0 \\ Df_0(y), & t = 0; \end{cases}$$

define  $g_t: \partial D \rightarrow S^{n-1}$  like  $g$ , using  $f_t$  instead of  $f$ . Since  $g_0$  is homotopic to  $g_1 = g$ , it follows that  $\text{deg } g_0 = \text{deg } g$ .

We claim  $\text{Ind}_0 f_0 = \text{Ind}_0 f$ . This is because the map

$$\Phi: D \times I \rightarrow \mathbb{R}^n \times I,$$

$$(y, t) \rightarrow (f_t(y), t)$$

is  $C^\infty$  (see proof of Theorem 4.4.3) and  $T\Phi$  thus induces a homotopy between  $Df_0(0)$  and  $Df_1(0)$ .

It remains to prove  $\text{Ind}_0 f_0 = \text{deg } g_0$ . Now  $f_0$  is linear, and hence is homotopic through linear maps to an element of  $O(n)$ . Thus it suffices to prove the lemma for the special case where  $f$  is orthogonal. But then  $g = f$  and in this case the lemma is easy to verify:  $\text{Ind}_0 f = \pm 1 = \text{deg } g$  according as  $f$  preserves or reverses orientation.

QED

The degree of  $g: \partial D \rightarrow S^{n-1}$  in Lemma 2.8 is defined whenever  $x$  is an isolated zero of  $f: U \rightarrow \mathbb{R}^n$ , even if  $f$  is merely continuous. Moreover  $\text{deg } g$  is independent of  $D$ , by Theorem 1.6(b). This permits us to extend significantly the definition of  $\text{Ind}_x f$ . Let  $U \subset \mathbb{R}^n$  be an open set,  $f: U \rightarrow \mathbb{R}^n$  a vector field on  $U$  and  $x \in U$  an isolated zero of  $f$ . The *index of  $f$  at  $x$*  is

$\text{Ind}_x f = \text{deg } g$ , where for some  $n$ -disk  $D \subset U$  with center  $x = D \cap f^{-1}(0)$

$$g: \partial D \rightarrow S^{n-1},$$

$$g(y) = f(y)/|f(y)|.$$

If  $0$  is a regular value of  $f$  this agrees with the older definition. Note that  $\text{deg } g$  can take any integer value (for  $n \geq 2$ ).

**2.9. Lemma.** *Let  $W \subset \mathbb{R}^n$  be a connected compact  $n$ -dimensional submanifold and  $f: W \rightarrow \mathbb{R}^n$  a  $C^\infty$  map. Assume  $f^{-1}(0)$  is a finite subset of  $W - \partial W$ . If*

$$\sum \text{Ind}_x f = 0, \quad (x \in f^{-1}(0))$$

there is a map  $g: W \rightarrow \mathbb{R}^n - 0$  which equals  $f$  on  $\partial W$ ; and conversely.

*Proof.* Let  $f^{-1}(0) = \{x_1, \dots, x_k\}$ . Let  $D_1, \dots, D_k$  be small disjoint  $n$ -disks in  $\text{Int } W$ , centered at  $x_1, \dots, x_k$  respectively.

Let  $W_0 = W - \cup \text{Int } D_i$ . Then  $\partial W_0 = \partial W \cup \bigcup_{i=1}^k \partial D_i$  and  $f(W_0) \subset \mathbb{R}^n - 0$ .

Notice that  $\text{deg}(f|_{\partial W_0}) = 0$  by 1.8. Define

$$g: W_0 \rightarrow S^{n-1},$$

$$y \mapsto f(y)/|f(y)|.$$

According to the preceding lemma,

$$\sum_{i=1}^k \text{deg}(g|_{\partial D_i}) = 0.$$

It follows that  $\text{deg}(g|_{\partial W}) = 0$ ; by Theorem 1.8 there is a map  $W \rightarrow S^{n-1}$  extending  $g|_{\partial W}$ . The composition

$$\partial W \xrightarrow{g} S^{n-1} \rightarrow \mathbb{R}^n - 0$$

is homotopic to  $f|_{\partial W}$ . Since  $g$  extends over  $W$ , so does  $f|_{\partial W}$ . The converse part of Theorem 2.9 is left to the reader.

QED

We can now prove the converse of Theorem 2.2.

**2.10. Theorem.** *Let  $M$  be a compact connected oriented  $n$ -manifold without boundary and  $\xi$  an oriented  $n$ -plane bundle over  $M$ . If  $X(\xi) = 0$  then  $\xi$  has a nonvanishing section.*

*Proof.* Let  $f: M \rightarrow \xi$  be a  $C^\infty$  section transverse to  $M$ . By Lemma 2.6 we may assume that the finite set  $f^{-1}(M)$  lies in the domain of the chart  $\varphi: U \approx \mathbb{R}^n$ . Let  $\psi: \xi_U \rightarrow U \times \mathbb{R}^n$  be a bundle chart. The map

$$\psi \circ f \circ \varphi^{-1}: \mathbb{R}^n \rightarrow T\mathbb{R}^n = \mathbb{R}^n \times \mathbb{R}^n$$

is a vector field on  $\mathbb{R}^n$  transverse to the zero section, or what is the same

thing, a map  $g: \mathbb{R}^n \rightarrow \mathbb{R}^n$  transverse to 0. The assumption  $X(\xi) = 0$  implies that

$$\sum_x \text{Ind}_x g = 0 \quad (x \in g^{-1}(0)).$$

Let  $B \subset \mathbb{R}^n$  be an  $n$ -disk containing  $g^{-1}(0)$  in its interior. By Theorem 2.9 there is a map  $h: \mathbb{R}^n \rightarrow \mathbb{R}^n - 0$  which equals  $g$  on  $\mathbb{R}^n - \text{Int } B$ . Define

$$f_1: M \rightarrow \xi, \\ f_1(x) = \begin{cases} f(x) & \text{if } x \in M - \varphi^{-1}(\text{Int } B) \\ \psi_x^{-1}(\varphi(x), h\varphi(x)) & \text{if } x \in B. \end{cases}$$

Then  $f_1$  is nonvanishing.

QED

We use all the preceding results to prove a classical theorem of Whitney [3]. We follow Whitney's proof.

**2.11. Theorem.** *Let  $M \subset \mathbb{R}^{2n}$  be a compact oriented  $n$ -dimensional submanifold without boundary. Then  $M$  has a nonvanishing normal vector field.*

*Proof.* We may assume  $M$  connected. Let  $\nu$  be the normal bundle of  $M$ . By Theorem 2.10 it suffices to prove that  $X(\nu) = 0$ . We identify a neighborhood  $W$  of the zero section of  $\nu$  with a neighborhood of  $M$  in  $\mathbb{R}^{2n}$ . Then

$$X(\xi) = \#(M, M; W) = \#(M, M; \mathbb{R}^{2n}) = 0.$$

QED

If  $M$  in Theorem 2.11 is not assumed orientable, the conclusion may be false, as Whitney showed for  $P^2 \subset \mathbb{R}^4$ .

### Exercises

1. Consider complex projective  $m$ -space  $CP^m$  as a submanifold of  $CP^m$  in the natural way. Then (with natural orientations)

$$\#(CP^m, CP^{m-m}) = 1.$$

A similar result holds mod 2 for real projective spaces.

2.  $\#(f, N; W) = 0$  if  $f: M \rightarrow W$  extends to an oriented compact manifold bounded by  $M$ , or if  $N$  bounds a closed oriented submanifold of  $W$ , or if  $f$  or  $N$  is null homotopic in  $W$ . Similarly for  $\#_2(f, N)$ .

3. Let  $M$  be a compact oriented manifold without boundary. Let

$$M_A = \{(x, x) \in M \times M\}$$

be the diagonal submanifold.

(a)  $\chi(M) = \#(M_A, M_A)$

(b)  $\chi(M) = 0$  if and only if there is a map  $f: M \rightarrow M$  without fixed point, which is homotopic to the identity. This is true even if  $M$  is nonorientable.

### 2. Intersection Numbers and the Euler Characteristic

4. Let  $M, N, W$  be oriented manifolds without boundaries,  $\dim M + \dim N = \dim W$ . The intersection number of maps  $f: M \rightarrow W, g: N \rightarrow W$  is defined as

$$\#(f, g) = \#(f \times g, W; W \times W).$$

This integer depends only on the homotopy classes of  $f$  and  $g$ . If  $g$  is an embedding then

$$\#(f, g) = \#(f, g(N)).$$

In general

$$\#(g, f) = (-1)^{\dim M \dim N} \#(f, g).$$

For unoriented manifolds a mod 2 intersection number is defined similarly.

5. Let  $\xi_i = (p_i, E_i, M_i), i = 0, 1$ , be oriented  $n$ -plane bundles over compact oriented  $n$ -manifolds without boundary. Put

$$\xi_0 \times \xi_1 = (p_0 \times p_1, E_0 \times E_1, M_0 \times M_1).$$

Then

$$X(\xi_0 \times \xi_1) = X(\xi_0)X(\xi_1).$$

6. Let  $\xi$  be an  $n$ -plane bundle over a connected  $k$ -manifold  $M$ .

(a) If  $k < n$ ,  $\xi$  has a nonvanishing section.

(b) If  $k = n$  and  $x \in M$ ,  $\xi$  has a section which vanishes only at  $x$ .

(c) If  $k = n$ , and  $\partial M \neq \emptyset$  or  $M$  is not compact, then  $\xi$  has a nonvanishing section.

7. (a) Suppose a compact  $n$ -manifold can be expressed as  $A \cup B$  where  $A, B$  are compact  $n$ -dimensional submanifolds and  $A \cap B$  is an  $(n-1)$ -dimensional submanifold. Then  $\chi(A \cap B) = \chi(A) + \chi(B) - \chi(A \cup B)$ .

(b)  $\chi(\partial A)$  is even. [Hint: take  $B \approx A$ .]

8. The Euler characteristic of an (orientable) surface of genus  $g$  is  $2 - 2g$ . [Use Exercise 7.]

9. Let  $M$  be a possibly nonorientable compact manifold without boundary, and  $G: M \rightarrow M \times M$  a  $C^\infty$  map. Then the integer  $L(G) = \#(G, M; M \times M)$  is well-defined using arbitrary local orientations of  $M$  at points  $x$  where  $G(x) \in M$ , and the corresponding local orientations of  $M \times M$  and  $M$  at  $(x, x)$ . Moreover  $L(G)$  is a homotopy invariant and so is defined for continuous maps  $G$ . If  $g: M \rightarrow M$  is any continuous map, the Lefschetz number of  $g$  is the integer  $\text{Lef}(g) = L(G)$  where  $G(x) = (x, g(x))$ .  $\text{Lef}(g)$  is a homotopy invariant of  $g$ . The Lefschetz number of  $1_M$  is  $\chi(M)$ . If  $\text{Lef}(g) \neq 0$  then  $g$  has a fixed point.

10. Let  $x \in M$  be an isolated fixed point of a continuous map  $g: M \rightarrow M$ . Let  $\varphi: U \rightarrow \mathbb{R}^n$  be a chart at  $x$ ; put  $\varphi(x) = y$ . The vector field  $f(z) = \varphi g \varphi^{-1}(z) - z$  is defined on a neighborhood of  $y$  in  $\mathbb{R}^n$  and has  $y$  for an isolated zero. Define

$$\text{Lef}_x(g) = \text{Ind}_y f.$$

This is independent of  $(\varphi, U)$ . If  $g$  is  $C^1$  then

$$\text{Lef}_x(g) = \text{Det}(T_x g - I), \quad I = \text{identity map of } M_x.$$

If the set  $\text{Fix}(g)$  of fixed points of  $g$  is finite, then (see Exercise 9)

$$\text{Lef}(g) = \sum_x \text{Lef}_x(g) \quad (x \in \text{Fix}(g)).$$

11. Every continuous map  $P^{2n} \rightarrow P^{2n}$  has a fixed point. [Consider maps of  $S^{2n}$  which commute with the antipodal map. See Exercises 9, 10.]

12. Lemma 2.9 is true even if the map  $f$  is merely continuous.



13. (a) There is a continuous map  $f: S^2 \rightarrow S^2$  of degree 2, that has exactly two periodic points. (A point  $x$  is *periodic* if  $f^n(x) = x$  for some  $n > 0$ .)

\*\* (b) If  $f: S^2 \rightarrow S^2$  is  $C^1$  and has degree  $d$  such that  $|d| > 1$ , then  $f$  has infinitely many periodic points. (Shub-Sullivan [1]).

\*\*\* (c) Identify the 2-torus  $T^2$  with the coset space  $\mathbb{R}^2/\mathbb{Z}^2$  and let  $f: T^2 \rightarrow T^2$  be the diffeomorphism induced from the linear operator on  $\mathbb{R}^2$  whose matrix is  $\begin{bmatrix} 2 & 1 \\ 1 & 1 \end{bmatrix}$ . Shub and Sullivan ask: if  $g: T^2 \rightarrow T^2$  is a continuous map homotopic to  $f$ , must  $g$  have infinitely many periodic points?

14. Let  $M, N$  be compact oriented  $n$ -manifolds without boundary; assume  $N$  is connected. Then the degree of a map  $f: M \rightarrow N$  equals the intersection number of the graph of  $f$  with  $M \times y$  in  $M \times N$ , for any  $y \in N$ .

\*15. Using intersection numbers and some elementary homotopy theory one can prove that every diffeomorphism of the complex projective plane  $CP^2$  preserves orientation. Using the fact that  $\pi_2(CP^2)$  is infinite cyclic, generated by the natural inclusion  $i: S^2 = CP^1 \subset CP^2$ , one sees that if  $h: CP^2 \approx CP^2$  then  $h_*[i] = \pm[i]$  in  $\pi_2(CP^2)$ . Therefore

$$\#(hi, hi) = \#(i, i) = 1$$

(see Exercise 4). On the other hand it is easy to see that for any maps

$$\begin{aligned} f, g: S^2 &\rightarrow CP^2, \\ \#(hf, hg) &= (\deg h)[\#(f, g)]. \end{aligned}$$

Therefore  $\deg h = 1$ .

16. Theorem 2.11 generalizes as follows. Let  $M^n \subset N^{2n}$  be a compact submanifold. Suppose  $M^n$  and  $N^{2n}$  are orientable and  $M^n \simeq 0$  in  $N^{2n}$ . Then  $M^n$  has a nonvanishing normal vector field (for any Riemannian metric on  $N^{2n}$ ).

17. What is the degree of the map  $CP^n \rightarrow CP^n$  defined by

$$[z_0, \dots, z_n] \mapsto [w_0, \dots, w_n]$$

where  $w_j = (\sum_k A_{jk} z_k)^p$ , if  $p$  is an integer and  $[A_{jk}] \in GL(n, \mathbb{C})$ ?

18. What is the Euler number of the normal bundle of  $CP^n$  in  $CP^{2n}$ ?

19. Let  $\xi \rightarrow S^n$  be an orthogonal oriented  $n$ -plane bundle.

(a)  $\xi$  corresponds to an element  $\alpha \in \pi_{n-1}(SO(n))$ . (Compare Exercise 8, Section 4.3.)

(b)  $X(\xi)$  is the image of  $\alpha$  in  $\pi_{n-1}(S^{n-1}) = \mathbb{Z}$  by the homomorphism

$$f_p: \pi_{n-1}(SO(n)) \rightarrow \pi_{n-1}(S^{n-1})$$

induced by the map  $f: SO(n) \rightarrow S^{n-1}$ , where  $f$  is defined by evaluation on the north pole  $P \in S^{n-1}$ .

\*20. Verify the statement of Heegard quoted at the beginning of Chapter 4.

21. Every vector field transverse to the boundary of the  $n$ -disk must have a zero in the interior.

22. Let  $p$  be a singularity of a vector field  $f$  on an open set in  $\mathbb{R}^n$ . If  $Df(p)$  has  $k$  eigenvalues with negative real part and  $n-k$  with positive real part, then  $\text{Ind}_p f = (-1)^{n-k}$ .

### 3. Historical Remarks

The origin of the notion of the degree is Kronecker's "characteristic of a system of functions" defined in 1869. The type of problem Kronecker

studied was the following (in modern terminology). Let  $F_0, \dots, F_n$  be  $C^1$  maps from  $\mathbb{R}^n$  to  $\mathbb{R}$ . Suppose  $0 \in \mathbb{R}$  is a regular value for each of them, and that each submanifold  $M_i = F_i^{-1}(-\infty, 0]$  is compact. If there is no common zero of  $F_0, \dots, F_n$  on  $\partial M_i$  for  $i = 1, \dots, n$ , how many common zeros are there for the  $n$  maps  $F_j: M_i \rightarrow \mathbb{R}$ ,  $j = 0, \dots, i-1, i+1, \dots, n$ ? Kronecker gave an integral formula which is equivalent to the degree of the composite map

$$\partial M_i \xrightarrow{G_i} \mathbb{R}^n - 0 \xrightarrow{\pi} S^{n-1}$$

where  $G_i = (F_0, \dots, F_{i-1}, F_{i+1}, \dots, F_n)$  and  $\pi(x) = x/|x|$ . He proved that this degree is independent of  $i$  and equals the algebraic number of zeros of  $G_i$  in  $M_i$ . He also showed that the total curvature of a compact surface  $M^2 \subset \mathbb{R}^3$  is  $2\pi$  times the degree of the Gauss map  $M^2 \rightarrow S^2$ . Later Walter von Dyck showed that the degree of the Gauss map equals the Euler characteristic of  $M$ , thus giving the first proof of what is now wrongly called the Gauss-Bonnet theorem.

An influential and still interesting article by Hadamard [1] in 1910 gave a more geometrical presentation of Kronecker's ideas. Kronecker's work is discussed in modern terms in the books by Lefschetz [1], and Alexandroff and Hopf [1].

The topological idea of the degree of a map is due to Brouwer [1]. Brouwer made fundamental contributions to the topology of manifolds (see Lefschetz [1] for an extensive bibliography). In his later years, however, he developed the intuitionistic view of mathematics and repudiated some of his earlier results.

Our treatment of the degree closely follows that of Pontryagin [1].

## Chapter 6

### Morse Theory

La topologie est précisément la discipline mathématique qui permet le passage du local au global.

—R. Thom, *Stabilité Structurale et Morphogénèse*, 1972

Up to this point we have obtained results of a very general nature: all  $n$ -manifolds embed in  $\mathbb{R}^{2n+1}$ , all maps can be approximated by  $C^\infty$  maps, etc. These are useful tools but they give no hint as to how to analyze a particular manifold, or class of manifolds. As yet we are unable even to classify compact 2-manifolds.

In this chapter we analyze the level sets  $f^{-1}(y)$  of a function  $f: M \rightarrow \mathbb{R}$  having only the simplest possible critical points. Such a function is called a “Morse function.” The decomposition of  $M$  into these level sets contains an amazing amount of information about the topology of  $M$ . For example we will show in Section 6.4 how a CW-complex, homotopy equivalent to  $M$ , can be obtained from any Morse function. In Section 6.3 the Morse inequalities are proved. These relate the critical points of  $f$  to the homology groups of  $M$ ; in particular they compute the Euler characteristic of  $M$  from any Morse function on  $M$ .

Morse functions are shown in Section 6.1 to be open and dense in  $C_r^2(M, \mathbb{R})$ ,  $2 \leq r \leq \infty$ . At each critical point a special kind of chart is constructed, making a Morse function look like a nondegenerate quadratic form. The index of this form is called the index of the critical point. These charts give a complete local analysis of the function.

In Section 6.2, which starts out with some facts about differential equations, the sets  $f^{-1}[a, b]$  which contain no critical point are investigated. Under mild restrictions it is shown that  $f^{-1}[a, b] \approx f^{-1}(a) \times [a, b]$ .

Section 6.3 contains the heart of Morse theory. Suppose  $f^{-1}[a, b]$  contains exactly one critical point, of index  $k$ . It turns out that up to homotopy equivalence,  $f^{-1}[a, b]$  is obtained from  $f^{-1}(a)$  by attaching a  $k$ -cell. This leads directly to the Morse inequalities, and to the construction of a CW-complex homotopy equivalent to  $M$  which has one  $k$ -cell for each critical point of index  $k$ .

We have presented only the very beginning of Morse theory. For the subject's important applications to such fields as differential geometry and the calculus of variations the reader should consult M. Morse [1], Milnor [3], Palais [1], or Smale [3].

## 1. Morse Functions

Let  $M$  be a manifold of dimension  $n$ . The cotangent bundle  $T^*M$  is defined like the tangent bundle  $TM$  using the dual vector space  $(\mathbb{R}^n)^* = L(\mathbb{R}^n, \mathbb{R})$  instead of  $\mathbb{R}^n$ . More precisely, as a set  $T^*M = \bigcup_{x \in M} (M_x^*)$  where  $M_x^* = L(M_x, \mathbb{R})$ . If  $(\varphi, U)$  is a chart on  $M$ , a natural chart on  $T^*M$  is the map

$$T^*U \rightarrow \varphi(U) \times (\mathbb{R}^n)^*$$

which sends  $\lambda \in M_x^*$  to  $(\varphi(x), \lambda\varphi_x^{-1})$ . The projection map  $p: T^* \rightarrow M$  sends  $M_x^*$  to  $x$ .

Let  $f: M \rightarrow \mathbb{R}$  be a  $C^{r+1}$  map,  $1 \leq r \leq \omega$ . For each  $x \in M$  the linear map  $T_x f: M_x \rightarrow \mathbb{R}$  belongs to  $M_x^*$ . We write

$$T_x f = Df_x \in M_x^*.$$

Then the map

$$\begin{aligned} Df: M &\rightarrow T^*M, \\ x &\mapsto Df_x = Df(x) \end{aligned}$$

is a  $C^r$  section of  $T^*M$ . The local representation of  $Df$ , in terms of a chart on  $M$  and the corresponding natural chart on  $T^*M$ , is a map from an open set in  $\mathbb{R}^n$  to  $(\mathbb{R}^n)^*$ , of the form  $x \mapsto Dg(x)$  where  $g$  is the local representation of  $f$ . Thus  $Df$  generalizes the usual differential of functions on  $\mathbb{R}^n$ .

A critical point  $x$  of  $f$  is a zero of  $Df$ , that is,  $Df(x)$  is the zero of the vector space  $M_x^*$ . Thus the set of critical points of  $f$  is the counter-image of the submanifold  $Z^* \subset T^*M$  of zeroes. Note that  $Z^* \approx M$  and the codimension of  $Z^*$  is  $n = \dim M$ .

A critical point  $x$  of  $f$  is *nondegenerate* if  $Df$  is transverse to  $Z^*$  at  $x$ . If all critical points of  $f$  are nondegenerate  $f$  is called a *Morse function*. In this case the set of critical points is a closed discrete subset of  $M$ .

The idea behind the definition of nondegenerate critical point is this. By means of local coordinates, assume  $M = \mathbb{R}^n$  and  $x \in \mathbb{R}^n$  is a critical point for  $f: \mathbb{R}^n \rightarrow \mathbb{R}$ . It is easy to see that  $x$  is nondegenerate precisely when  $x$  is a regular point for  $Df: \mathbb{R}^n \rightarrow (\mathbb{R}^n)^*$ . Therefore as  $y$  varies in a small neighborhood of  $x$ ,  $Df_y$  takes on every value in a neighborhood of 0 in  $(\mathbb{R}^n)^*$  exactly once. Moreover as  $y$  moves away from  $x$  with nonzero velocity,  $Df_y$  moves away from 0 with nonzero velocity.

Let  $U \subset \mathbb{R}^n$  be open and let  $g: U \rightarrow \mathbb{R}$  be a  $C^2$  map. It is easy to see that a critical point  $p \in U$  is nondegenerate if and only if the linear map

$$D(Dg)(p): \mathbb{R}^n \rightarrow (\mathbb{R}^n)^*$$

is bijective. Identify  $L(\mathbb{R}^n, (\mathbb{R}^n)^*)$  with the space of bilinear maps  $\mathbb{R}^n \times \mathbb{R}^n \rightarrow \mathbb{R}$ ; we see that this is equivalent to the condition that the symmetric bilinear map  $D^2g(p): \mathbb{R}^n \times \mathbb{R}^n \rightarrow \mathbb{R}$  be nondegenerate. In terms of coordinates this means that the  $n \times n$  Hessian matrix

$$\left[ \frac{\partial^2 g}{\partial x_i \partial x_j} (p) \right]$$

has rank  $n$ . This provides a criterion in local coordinates for a critical point of a map  $M \rightarrow \mathbb{R}$  to be nondegenerate.

Let  $p \in U$  be a critical point of  $g: U \rightarrow \mathbb{R}$ . The Hessian of  $g$  at the critical point  $p$  is the quadratic form  $H_p f$  associated to the bilinear form  $D^2g(p)$ ; thus

$$H_p f(y) = D^2g(p)(y, y) = \sum_{i, j} \frac{\partial^2 g}{\partial x_i \partial x_j}(p) y_i y_j.$$

This form is invariant under diffeomorphisms in the following sense. Let  $V \subset \mathbb{R}^n$  be open and suppose  $h: V \rightarrow U$  is a  $C^2$  diffeomorphism. Let  $q = h^{-1}(p)$  so that  $q$  is a critical point of  $gh: V \rightarrow \mathbb{R}$ . Then the diagram commutes,

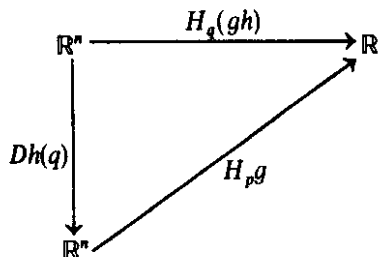

as a computation shows.

Now let  $f: M \rightarrow \mathbb{R}$  be  $C^2$ . For each critical point  $x$  of  $f$  we define the Hessian quadratic form  $H_x f: M_x \rightarrow \mathbb{R}$  to be the composition

$$H_x f: M_x \xrightarrow{D\varphi_x} \mathbb{R}^n \xrightarrow{H_{\varphi^{-1}} f} \mathbb{R}$$

where  $\varphi$  is any chart at  $x$ . The invariance property of Hessians of functions on  $\mathbb{R}^n$  implies that  $H_x f$  is well-defined independently of  $\varphi$ . Note that  $x$  is a nondegenerate critical point if and only if  $H_x f$  is a nondegenerate quadratic form. Thus we obtain an alternate definition: a critical point of a  $C^2$  real valued function is nondegenerate if and only if the associated Hessian quadratic form is nondegenerate.

Now let  $Q$  be a nondegenerate quadratic form on a vector space  $E$ . We say  $Q$  is *negative definite* on a subspace  $F \subset E$  if  $Q(x) < 0$  whenever  $x \in F$  is nonzero. The largest possible dimension of a subspace on which  $Q$  is negative definite is the *index* of  $Q$ , denoted by  $\text{Ind } Q$ . If  $A = [a_{ij}]$  is a symmetric  $n \times n$  matrix expressing  $Q(x)$  as  $\sum a_{ij} x_i x_j$  for some choice of linear coordinates on  $E$ , then the index of  $Q$  equals the number of negative eigenvalues of  $A$ , counting multiplicities.

Let  $p \in M$  be a nondegenerate critical point of  $f: M \rightarrow \mathbb{R}$ . The *index* of  $p$  is the index of the Hessian of  $f$  at  $p$ , denoted by  $\text{Ind}(p)$  or  $\text{Ind}_f(p)$ .

This number gives us valuable information about the local behavior of  $f$  near  $x$ . Suppose that  $M = \mathbb{R}^n$  and  $p = 0$ . The second-order Taylor expansion of  $f$  at 0 looks like

$$f(x) = f(0) + \frac{1}{2} H_0 f(x) + R(x)$$

where  $R(x)/|x|^2 \rightarrow 0$  as  $x \rightarrow 0$ . Thus  $f$  is approximately a constant plus half the Hessian at 0. Let  $E_- \oplus E_+$  be a direct sum decomposition of  $\mathbb{R}^n$  so that  $H_0 f$  is negative definite on  $E_-$  and positive definite on  $E_+$ , and

$$\begin{aligned} \dim E_- &= k = \text{Ind } H_0 f \\ \dim E_+ &= n - k \end{aligned}$$

Then if  $x \in \mathbb{R}^n$  and  $t \in \mathbb{R} - 0$  are sufficiently small,  $f(tx)/t$  is a decreasing function of  $t$  for  $x \in E_-$  and an increasing function of  $t$  for  $x \in E_+$ .

It follows that for a Morse function  $f: M \rightarrow \mathbb{R}$ , a critical point  $p$  is a local minimum if and only if  $\text{Ind}(p) = 0$ , and a local maximum if and only if  $\text{Ind}(p) = \dim M$ .

The following result of Marston Morse is a sharper form of this relation between  $f$  and its Hessian at a nondegenerate critical point  $p$ . It states that  $f$  has a local representation at  $p$  which equals  $f(p) + \frac{1}{2} H_p f$ .

**1.1. Morse's Lemma.** *Let  $p \in M$  be a nondegenerate critical point of index  $k$  of a  $C^{r+2}$  map  $f: M \rightarrow \mathbb{R}$ ,  $1 \leq r \leq \omega$ . Then there is a  $C^r$  chart  $(\varphi, U)$  at  $p$  such that*

$$f \varphi^{-1}(u_1, \dots, u_n) = f(p) - \sum_{i=1}^k u_i^2 + \sum_{i=k+1}^n u_i^2$$

The proof is based on the following parametric form of the diagonalization of symmetric matrices. Let  $'Q$  denote the transpose of the matrix  $Q$ .

**Lemma.** *Let  $A = \text{diag}\{a_1, \dots, a_n\}$  be a diagonal  $n \times n$  matrix with diagonal entries  $\pm 1$ . Then there exists neighborhood  $N$  of  $A$  in the vector space of symmetric  $n \times n$  matrices, and a  $C^\infty$  map*

$$P: N \rightarrow GL(n, \mathbb{R})$$

such that  $P(A) = I$  (the identity matrix), and if  $P(B) = Q$  then  $'QBQ = A$ .

*Proof of Lemma.* Let  $B = [b_{ij}]$  be a symmetric matrix so near to  $A$  that  $b_{11}$  is nonzero and has the same sign as  $a_1$ . Consider the linear coordinate change in  $\mathbb{R}^n$ :  $x = Ty$  where

$$\begin{aligned} x_1 &= \left[ y_1 - \frac{b_{12}}{b_{11}} y_2 - \dots - \frac{b_{1n}}{b_{11}} y_n \right] / \sqrt{|b_{11}|} \\ x_k &= y_k \quad \text{for } k = 2, \dots, n. \end{aligned}$$

One verifies that  $'TBT$  has the form

$$\begin{bmatrix} a_1 & 0 & \dots & 0 \\ 0 & & & \\ \cdot & & & \\ \cdot & & B_1 & \\ \cdot & & & \\ 0 & & & \end{bmatrix}$$

If  $B$  is near enough to  $A$  then the symmetric  $(n - 1) \times (n - 1)$  matrix  $B_1$  will be as close as desired to the diagonal matrix  $A_1 = \text{diag}\{a_2, \dots, a_n\}$ ; in particular it will be invertible. Note that  $T$  and  $B_1$  are  $C^\infty$  functions of  $B$ . By induction on  $n$  we assume there exists a matrix  $Q_1 = P_1(B_1) \in GL(n - 1)$  depending analytically on  $B_1$ , such that  ${}^tQ_1 B_1 Q_1 = A_1$ . Define  $P(B) = Q$  by  $Q = TS$  where

$$S = \begin{bmatrix} 1 & 0 & \cdots & 0 \\ 0 & & & \\ \vdots & & Q_1 & \\ \vdots & & & \\ 0 & & & \end{bmatrix};$$

then  ${}^tQBQ = A$ .

QED

*Proof of Morse's Lemma.* We may assume  $M$  is a convex open set in  $\mathbb{R}^n$ ,  $p = 0 \in \mathbb{R}^n$ , and  $f(0) = 0 \in \mathbb{R}$ . By a linear coordinate change we may assume that the matrix

$$A = \left[ \frac{\partial^2 f}{\partial x_i \partial x_j} (0) \right]$$

is diagonal, with the first  $k$  diagonal entries equal to  $-1$  and the rest equal to  $+1$ . By assumption  $Df(0) = 0$ .

There exists a  $C^r$  map  $x \mapsto B_x$  from  $M$  to the space of symmetric  $n \times n$  matrices such that if  $x \in M$  and  $B_x = [b_{ij}(x)]$  then

$$f(x) = \sum_{i,j=1}^n b_{ij}(x)x_i x_j$$

and  $B_0 = A$ . This follows, for example, from the fundamental theorem of calculus applied twice:

$$\begin{aligned} f(x) &= \int_0^1 Df(tx)x \, dt \\ &= \sum_{j=1}^n \left[ \int_0^1 \frac{\partial f}{\partial x_j}(tx) \, dt \right] x_j \\ &= \sum_{i,j=1}^n \left[ \int_0^1 \int_0^1 \frac{\partial^2 f}{\partial x_j \partial x_i}(stx) \, ds \, dt \right] x_i x_j \\ &= \sum_{i,j=1}^n b_{ij}(x)x_i x_j. \end{aligned}$$

Let  $P(B)$  be the matrix valued function in the lemma; put  $P(B_x) = Q_x \in GL(n)$ . Define a  $C^r$  map  $\varphi: U \rightarrow \mathbb{R}^n$ , where  $U \subset M$  is a sufficiently small neighborhood of  $0$ :

$$\varphi(x) = Q_x^{-1}x.$$

A calculation shows that  $D\varphi(0) = I$ ; therefore by the inverse function theorem we may assume  $(\varphi, U)$  is a  $C^r$  chart.

Put  $y = \varphi(x)$ ; then, in matrix notation:

$$\begin{aligned} f(x) &= {}^t x B_x x \\ &= {}^t y ({}^t Q_x B_x Q_x) y \\ &= {}^t y A y \\ &= \sum_{i=1}^n a_{ii} y_i^2. \end{aligned}$$

QED

We now have a *complete local description* of a Morse function  $f: M \rightarrow \mathbb{R}$ . If  $a \in M$  is a regular point then by the implicit function theorem there are coordinates near  $a$  such that

$$f(x_1, \dots, x_n) = x_1.$$

If  $a$  is a critical point there are coordinates near  $a$  such that

$$f(x_1, \dots, x_n) = f(a) - x_1^2 - \cdots - x_k^2 + x_{k+1}^2 + \cdots + x_n^2.$$

The index  $k$  is uniquely determined by the critical point.

It follows that the level sets  $f^{-1}(y)$  of a Morse function have nice local structure. Near a regular point  $f^{-1}(y)$  looks like a hyperplane in  $\mathbb{R}^n$ . At a critical point there is a chart  $(\varphi, U)$  throwing  $U \cap f^{-1}(y)$  onto a neighborhood of  $0$  in the degenerate quadric hypersurface

$$-x_1^2 - \cdots - x_k^2 + x_{k+1}^2 + \cdots + x_n^2 = 0;$$

nearby level surfaces in  $U$  go onto open subsets of the nondegenerate quadrics

$$-x_1^2 - \cdots - x_k^2 + x_{k+1}^2 + \cdots + x_n^2 = \text{constant} \neq 0.$$

See Figure 6-1 for some examples.

As the value of the Morse function increases past a critical value, the topological character of the level surfaces changes suddenly. This is studied in detail in the following sections.

We close this section with:

**1.2. Theorem.** For any manifold  $M$ , Morse functions form a dense open set in  $C^2_s(M, \mathbb{R})$ ,  $2 \leq s \leq \infty$ .

*Proof.* The cotangent vector bundle  $T^*M$  is isomorphic to  $J^1(M, \mathbb{R})$ , the bundle of 1-jets of maps  $M \rightarrow \mathbb{R}$ ; a natural isomorphism is defined by sending  $j_x^1 f \in J_x^1(M, \mathbb{R})$  to  $Df_x \in T_x^*M$ . Thus a  $C^2$  map  $f: M \rightarrow \mathbb{R}$  is a Morse function if and only if its 1-prolongation

$$j^1 f: M \rightarrow J^1(M, \mathbb{R})$$

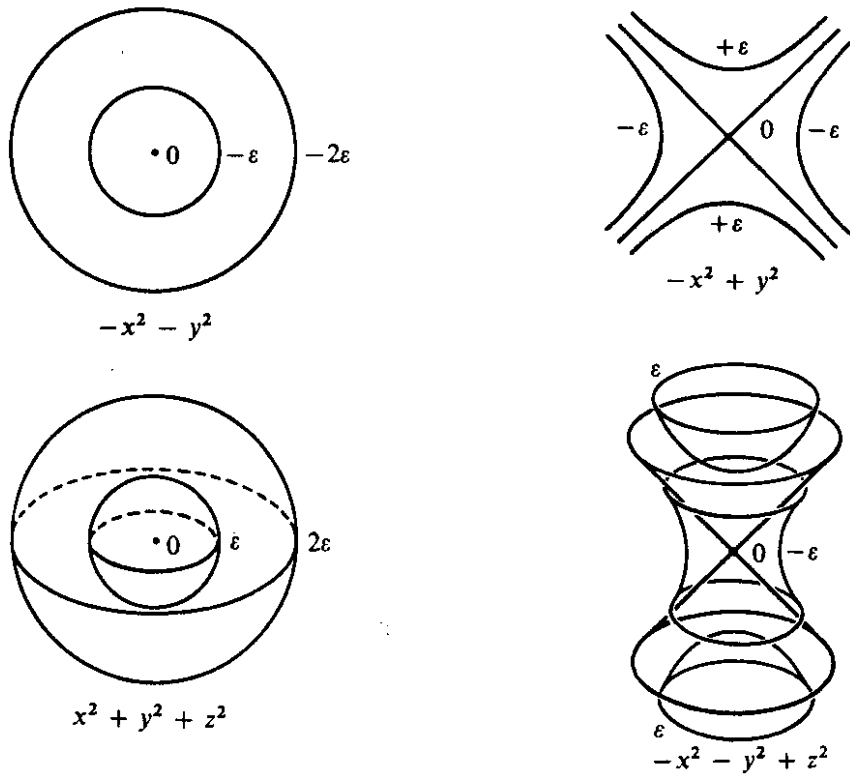

Figure 6-1.

is transverse to the zero section. The theorem now follows from jet transversality (Theorem 3.2.8).

QED

**Exercises**

- \*\*1. In Morse's lemma  $C^{r+2}$  can be replaced by  $C^{r+1}$ . (Assume  $M = \mathbb{R}^n$ ,  $p = 0$ ,  $f(p) = 0$ . Put  $\frac{1}{2}D^2f(0)(x,x) = Q(x)$ . Let  $t \mapsto \xi(t,x)$  be the solution of the differential equation  $dx/dt = \text{grad } Q(x)$  such that  $\xi(0,x) = 0$ . For  $x$  near 0 there is a unique  $t(x)$  such that  $Q\xi(t(x),x) = f(x)$ . Define  $\varphi(x) = \xi(t(x),x)$ . See Kuiper [1], Takens [i].)
- 2. Let  $M \subset \mathbb{R}^{n+1}$  be a compact  $C^2$  submanifold. For each  $v \in S^n$  let  $f_v: M \rightarrow \mathbb{R}$  be the map  $f_v(x) = \langle v, x \rangle$ . (This is essentially orthogonal projection into the line through  $v$ .) Then the set of  $v \in S^n$  such that  $f_v$  is a Morse function is open and dense.
- 3. Let  $M \subset \mathbb{R}^n$  be a  $C^2$  submanifold and  $f: M \rightarrow \mathbb{R}$  a  $C^2$  map. The set of linear maps  $L \in L(\mathbb{R}^n, \mathbb{R})$  such that the map  $M \rightarrow \mathbb{R}$ ,  $x \mapsto f(x) + L(x)$  is a Morse function, is a Baire set and thus dense. If  $M$  is compact it is open and dense.
- 4. Let  $M \subset \mathbb{R}^n$  be a closed compact  $C^2$  submanifold. The set of points  $u \in \mathbb{R}^n$  such that the map  $x \mapsto |x - u|^2$  is a Morse function on  $M$ , is open and dense.

2. Differential Equations and Regular Level Surfaces

\*5. Let  $f_0, f_1: M \rightarrow \mathbb{R}$  be Morse functions. It may be impossible to find a  $C^2$  homotopy  $f: M \times [0,1] \rightarrow \mathbb{R}$  such that  $f(x,0) = f_0(x)$ ,  $f(x,1) = f_1(x)$  and each map  $f_t(x) = f(x,t)$  is a Morse function,  $0 \leq t \leq 1$ . However, a  $C^2$  homotopy from  $f_0$  to  $f_1$  can be found such that each  $f_t$  is a Morse function except for a finite set  $t_1, \dots, t_m$ ; for each  $j$ ,  $f_{t_j}$  has only one degenerate critical point  $z_j$ ; in suitable local coordinates at  $z_j$ ,  $f_{t_j}$  has the form:

$$-x_1^2 - \dots - x_k^2 + x_{k+1}^2 + \dots + x_{n-1}^2 + x_n^2 + R(x) + \text{constant}$$

where  $R(x)/|x|^3 \rightarrow 0$  as  $|x| \rightarrow 0$ . (Assume  $f$  is  $C^3$  and make the map  $(x,t) \mapsto f_t^2 f_t$  transverse to suitable submanifolds of  $J^2(M, \mathbb{R})$ .)

There is a Morse function on the projective plane which has exactly three critical points.

\*6. *Generalized Morse's lemma.* Let  $f: M \rightarrow \mathbb{R}$  be a  $C^{r+3}$  map. A submanifold  $V \subset M$  is *critical* if every point of  $V$  is a critical point. A critical submanifold  $V$  is *nondegenerate of index  $k$*  if every  $x \in V$  has the following property: for some (hence any) submanifold  $W \subset M$  which is transverse to  $V$  at  $x$ , the point  $x$  is a nondegenerate critical point of  $f|_W$  having index  $k$ . If also  $V \subset M - \partial M$ , and  $V$  is connected, then there is a  $C^r$  tubular neighborhood  $(\rho, \xi \oplus \eta)$  for  $(M, V)$  and an orthogonal structure on  $\xi \oplus \eta$  such that the composition  $E(\xi \oplus \eta) \subset M \xrightarrow{f} \mathbb{R}$  is given by

$$(x,y) \rightarrow -|x|^2 + |y|^2 + C$$

for  $(x,y) \in \xi_p \oplus \eta_p$ ,  $p \in V$ , where  $C$  is the constant  $f(V)$ .

2. Differential Equations and Regular Level Surfaces

We recall some facts about differential equations. Let  $W \subset \mathbb{R}^n$  be an open set and  $g: W \rightarrow \mathbb{R}^n$  a  $C^r$  map,  $1 \leq r \leq \omega$ , regarded as a vector field on  $W$ . Then locally  $g$  satisfies Lipschitz conditions, so the basic theorems about existence, uniqueness and differentiability of solutions of ordinary differential equations apply to the initial value problem:

$$(1) \quad \begin{aligned} \varphi'(t) &= g(\varphi(t)), \\ \varphi(0) &= x \end{aligned}$$

for each  $x \in W$ . Therefore there is an open interval  $J \subset \mathbb{R}$  about 0 and a  $C^{r+1}$  map

$$\varphi: (J,0) \rightarrow (W,x)$$

which satisfies (1). If  $\varphi_1: J_1 \rightarrow W$  is another solution to (1) then  $\varphi = \varphi_1$  on  $J \cap J_1$ . Thus  $\varphi$  and  $\varphi_1$  fit together to form a solution on  $J \cup J_1$ . It follows that  $J$  and  $\varphi$  are unique provided  $J$  is taken to be maximal. We call this maximal interval  $J(x)$ , and the corresponding solution is written variously as

$$\begin{aligned} \varphi^x: J(x) &\rightarrow W, \\ \varphi^x(t) &= \varphi_t(x) = \varphi(t,x). \end{aligned}$$

The maps  $\varphi^x$  and sometimes the sets  $\varphi^x(J(x))$  are called *solution curves* or *trajectories* or *flow lines* of the vector field  $g$ .

The interval-valued function  $x \mapsto J(x)$  is lower semicontinuous in the sense that if  $\alpha \in J(x)$  then  $\alpha \in J(y)$  for all  $y$  in some neighborhood of  $x$ . This implies that the set

$$\Omega = \{(t, x) \in \mathbb{R} \times W : t \in J(x)\}$$

is open in  $\mathbb{R} \times W$ .

The flow generated by  $g$  is the  $C^r$  map

$$\begin{aligned} \varphi: \Omega &\rightarrow W, \\ (t, x) &\mapsto \varphi_t(x). \end{aligned}$$

For each  $t \in \mathbb{R}$  let

$$W_t = \{x \in W : t \in J(x)\}.$$

Then  $W_t$  is open in  $W$  and there is defined a  $C^r$  map

$$\begin{aligned} \varphi_t: W_t &\rightarrow W, \\ x &\mapsto \varphi_t(x). \end{aligned}$$

Clearly  $\varphi_t(W_t) = W_{-t}$  and  $\varphi_{-t} = \varphi_t^{-1}$ . Thus  $\varphi_t$  is a  $C^r$  embedding. More generally we have the relations

$$\varphi_s \varphi_t(x) = \varphi_{s+t}(x),$$

valid in the sense that if one side is defined so is the other, and they are equal. It is not hard to prove that if  $K \subset \mathbb{R}$  is any interval and  $U \subset W$  is an open set such that  $U \subset \bigcap_{t \in K} W_t$ , then the map  $K \rightarrow \text{Emb}^r(K, W)$  is continuous for the weak topology.

Let  $P \subset W$  be compact. For each  $x \in W$  the set of  $t \in J(x)$  such that  $\varphi_t(x) \in P$ , is closed in  $\mathbb{R}$ , not merely in  $J(x)$ . This has the important consequence that if  $x \in P$  is such that  $\varphi_t(x) \in P$  for all  $t \in J(x) \cap \mathbb{R}_+$  then  $J(x) \supset \mathbb{R}_+$ , and similarly for  $\mathbb{R}_-$ . In particular if the trajectory of  $x$  has compact closure in  $W$  then  $J(x) = \mathbb{R}$ .

Now let  $X$  be a  $C^r$  vector field on an  $n$ -manifold  $M$ ; that is,  $X$  is a  $C^r$  section of  $TM$ . Assume first that  $\partial M = \emptyset$ .

An integral curve (or solution curve) of  $X$  is a differentiable map  $\eta: J \rightarrow M$  where  $J \subset \mathbb{R}$  is an interval and  $\eta'(t) = X(\eta(t))$  for each  $t \in J$ . If  $(\psi, U)$  is a chart on  $M$  (of class  $C^\infty$ , or  $C^r$  if  $r = \omega$ ) containing  $\eta(J)$  and  $W = \psi(U) \subset \mathbb{R}^n$  then the composite map

$$f: W \xrightarrow{\psi^{-1}} U \xrightarrow{X} TU \xrightarrow{D\psi} \mathbb{R}^n$$

is a  $C^r$  vector field on  $W$ . The map  $\varphi = \psi \circ \eta: J \rightarrow W$  satisfies the differential equation

$$(2) \quad \varphi'(t) = f(\varphi(t)),$$

because

$$\begin{aligned} \varphi'(t) &= D\psi(\eta'(t)) = D\psi(X_{\eta(t)}) \\ &= (D\psi \circ X \circ \psi^{-1})(\psi\eta(t)) \\ &= f(\varphi(t)). \end{aligned}$$

Thus  $\psi$  carries an integral curve of  $X$  into solution of (2), provided the integral curve lies in a coordinate domain.

All the results about vector fields on open sets in  $\mathbb{R}^n$  carry over to vector fields on  $M$ . For each  $x \in M$  there is a maximal open interval  $J(x)$  about 0 and a  $C^{r+1}$  integral curve (or trajectory, or flow line) of  $X$ ,

$$\begin{aligned} \eta^x: (J(x), 0) &\rightarrow (M, x) \\ \eta^x(t) &= \eta(t, x) = \eta_t(x). \end{aligned}$$

The set

$$\Omega = \{(t, x) \in \mathbb{R} \times M : t \in J(x)\}$$

is open in  $\mathbb{R} \times M$ ; the flow of  $X$  is the  $C^r$  map

$$\begin{aligned} \eta: \Omega &\rightarrow M, \\ (t, x) &\mapsto \eta_t(x). \end{aligned}$$

The previous results about endpoints of  $J(x)$  and compact subsets of  $M$  are still valid. An important case is where  $M$  is compact and without boundary. In this case  $\Omega = M \times \mathbb{R}$  and each  $\eta_t$  is a  $C^r$  diffeomorphism of  $M$ . Thus the maps  $\{\eta_t\}_{t \in \mathbb{R}}$  form a one-parameter group of  $C^r$  diffeomorphism of  $M$ : the map

$$\mathbb{R} \rightarrow \text{Diff}^r(M), \quad t \mapsto \eta_t$$

is continuous, and  $\eta_t \eta_s = \eta_{t+s}$ .

Unfortunately we must also consider vector fields on  $\partial$ -manifolds. Suppose now that  $\partial M \neq \emptyset$ . The preceding results can be used if we first embed  $M$  as a closed submanifold of an  $n$ -manifold  $N$  without boundary, such as the double of  $M$ , and then extend  $X$  to a  $C^r$  vector field on  $N$ . (This can be done with a partition of unity if  $1 \leq r \leq \infty$ , since local  $C^r$  extensions exist by definition. If  $r = \omega$  the local extensions are unique and fit together to give an analytic vector field on a neighborhood of  $M$  in  $N$ , which is all that is needed.)

If  $X$  is tangent to  $\partial M$ , that is, if  $X(\partial M) \subset T(\partial M)$ , everything is as before. But if  $X$  is not tangent to  $\partial M$ , the intervals  $J(x)$  will not all be open. If  $x \in \partial M$ ,  $X(x) \neq 0$ , and  $X(x)$  points into [respectively, out of]  $M$ , then  $J(x)$  will contain 0 as its left [resp. right] endpoint. It is also possible that  $X(x)$  is tangent to  $\partial M$  and still  $J(x)$  contains the endpoint 0; and  $J(x)$  can even be the degenerate interval  $\{0\}$ . For any  $y \in M$ , if  $J(y)$  contains an endpoint  $b$  then  $\eta(b, y) \in \partial M$ .

The set  $\Omega$ , defined as before, is not necessarily open in  $\mathbb{R} \times M$ , but its interior is dense. Moreover the flow  $\eta: \Omega \rightarrow M$  is  $C^r$  in the sense that it extends to a  $C^r$  map  $\Omega' \rightarrow N$  where  $\Omega' \subset \mathbb{R} \times N$  is open.

If the trajectory of  $x \in M$  has compact closure then  $J(x)$  is a closed interval; if also the trajectory lies in  $M - \partial M$  then  $J(x) = \mathbb{R}$ .

If  $J(x) = \mathbb{R}$  for all  $x \in M$  the vector field is called completely integrable. A necessary condition for  $X$  to be completely integrable is that  $X$  be tangent to  $\partial M$ . A sufficient condition is that  $X$  be tangent to  $\partial M$  and each trajectory

have compact closure. A more general sufficient condition is given in Exercise 1.

Differential equations can be used to prove anew the *collaring theorem*:

**2.1. Theorem.** *Let  $M$  be a  $\partial$ -manifold. Then there exists a  $C^\infty$  embedding*

$$F: \partial M \times [0, \infty) \rightarrow M$$

such that  $F(x, 0) = x$  for all  $x \in \partial M$ .

*Proof.* Using charts covering  $\partial M$  and a partition of unity, one finds a  $C^\infty$  vector field  $X$  on a neighborhood  $U \subset M$  of  $\partial M$  which is nowhere tangent to  $\partial M$  and which points into  $M$  (in local coordinates). Let  $W \subset \partial M \times [0, \infty)$  be a neighborhood of  $\partial M \times 0$  on which the flow  $\eta$  of the vector field is defined. There is a  $C^\infty$  embedding  $h: \partial M \times [0, \infty) \rightarrow W$  which leaves  $\partial M \times 0$  pointwise fixed. The required map  $F$  is the composition

$$F: \partial M \times [0, \infty) \xrightarrow{h} W \xrightarrow{\eta} M.$$

QED

We turn now to the construction of a vector field transverse to the regular level surfaces of a  $C^{r+1}$  map  $f: M \rightarrow \mathbb{R}$ ,  $r \geq 1$ . We assume  $M$  has been given a  $C^\infty$  Riemannian metric. The inner product in any  $M_x$  is denoted by  $\langle X, Y \rangle$ ; the corresponding norm is  $|X| = \langle X, X \rangle^{1/2}$ .

For every linear map  $\lambda: M_x \rightarrow \mathbb{R}$  there exists a unique tangent vector  $X_\lambda \in M_x$  such that  $\lambda(Y) = \langle X_\lambda, Y \rangle$  for all  $Y \in M_x$ . We call  $X_\lambda$  the vector dual to  $\lambda$ . The map  $\lambda \mapsto X_\lambda$  is a linear isomorphism from  $M_x^*$  onto  $M_x$ . Its inverse assigns to  $X \in M_x$  the linear map

$$\lambda_X: M_x \rightarrow \mathbb{R}, \quad Y \mapsto \langle X, Y \rangle.$$

If  $f: M \rightarrow \mathbb{R}$  is  $C^{r+1}$ , for each  $x \in M$  define the vector  $\text{grad } f(x) \in M_x$  to be the dual of  $Df_x$ . In this way the  $C^r$  gradient vector field  $\text{grad } f$  is defined. It depends on the Riemannian metric.

If  $M$  is open in  $\mathbb{R}^n$  and the metric is given by the standard inner product of  $\mathbb{R}^n$  then

$$\text{grad } f(x) = \left( \frac{\partial f}{\partial x_1}(x), \dots, \frac{\partial f}{\partial x_n}(x) \right).$$

It is clear that  $\text{grad } f(x) = 0$  if and only if  $x$  is a critical point of  $f$ . At a regular point  $\text{grad } f(x)$  is transverse to the level surface  $f^{-1}(f(x))$ ; in fact, they are orthogonal.

Notice that  $f$  is nondecreasing along gradient lines, that is, along solution curves of the gradient differential equation  $\eta' = \text{grad } f(\eta)$ . For if  $\eta(t)$  is a solution then

$$\begin{aligned} \frac{d}{dt} f(\eta(t)) &= \langle \text{grad } f(\eta(t)), \text{grad } f(\eta(t)) \rangle \\ &= |\text{grad } f(\eta(t))|^2 \geq 0. \end{aligned}$$

And  $f$  is strictly increasing along any solution curve which is not a critical point.

The following *regular interval theorem* is a useful way of finding diffeomorphisms.

**2.2. Theorem.** *Let  $f: M \rightarrow [a, b]$  be a  $C^{r+1}$  map on a compact  $\partial$ -manifold,  $1 \leq r \leq \omega$ . Suppose  $f$  has no critical points and  $f(\partial M) = \{a, b\}$ . Then there is a  $C^r$  diffeomorphism  $F: f^{-1}(a) \times [a, b] \rightarrow M$  so that the diagram*

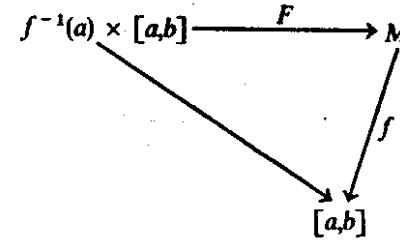

commutes. In particular all level surfaces of  $f$  are diffeomorphic.

*Proof.* Give  $M$  a Riemannian metric. Consider the  $C^r$  vector field on  $M$ :

$$X(x) = \frac{\text{grad } f(x)}{|\text{grad } f(x)|^2}.$$

Notice that  $X(x)$  has the same trajectories as  $\text{grad } f$  but with a different parametrization.

Let  $\eta: [t_0, t_1] \rightarrow M$  be a solution curve of  $X$ . A computation shows that the derivative of the map

$$[t_0, t_1] \rightarrow \mathbb{R}, \quad t \mapsto f(\eta(t))$$

is identically 1. This means that

$$(1) \quad f\eta(t_1) - f\eta(t_0) = t_1 - t_0.$$

Let  $x \in f^{-1}(s)$ . Since  $M$  is compact, the set  $J(x)$  is closed; from (1) it follows that

$$(2) \quad J(x) = [a - s, b - s].$$

The assumptions on  $f$  imply that  $f^{-1}(a)$  is a union of boundary components of  $M$ . Define a map

$$\begin{aligned} F: f^{-1}(a) \times [a, b] &\rightarrow M, \\ F(x, t) &= \eta(t - a, x). \end{aligned}$$

Since  $f$  increases along gradient lines, and thus along  $X$ -trajectories,  $F$  is injective. And  $F$  is an immersion because gradient lines are transverse to level surfaces. Thus  $F$  is an embedding. Finally,  $F$  is onto because of (2).

QED

**2.3. Corollary.** Let  $M$  be a compact manifold and assume  $\partial M = A \cup B$  where  $A$  and  $B$  are disjoint closed sets. Suppose there exists a  $C^2$  map  $f: M \rightarrow \mathbb{R}$  without critical point such that  $f(A) = 0, f(B) = 1$ . Then  $M$  is diffeomorphic to both  $A \times I$  and  $B \times I$ .

The following topological application of critical point theory is due to G. Reeb.

**2.4. Theorem.** Let  $M$  be a compact  $n$ -dimensional manifold without boundary, admitting a Morse function  $f: M \rightarrow \mathbb{R}$  with only 2 critical points. Then  $M$  is homeomorphic to the  $n$ -sphere  $S^n$ .

*Proof.* Let the critical points be  $P_+$  and  $P_-$ . We may assume  $P_+$  is a maximum and  $P_-$  a minimum. Put  $f(P_+) = z_+, f(P_-) = z_-$ . By Morse's lemma there are coordinates  $(x_1, \dots, x_n)$  in a neighborhood  $U_+$  of  $P_+$  giving  $f|U_+$  the form

$$-x_1^2 - \dots - x_n^2 + z_+.$$

Therefore there exists  $b < z_+$  such that the set

$$D_+ = f^{-1}[b, z_+]$$

is a neighborhood of  $P_+$  diffeomorphic to the  $n$ -disk  $D^n$ .

Similarly there exists  $a > z_-$  such that the set

$$D_- = f^{-1}[z_-, a]$$

is a neighborhood of  $P_-$  diffeomorphic to  $D^n$ . We assume  $z_- < a < b < z_+$ . Note that

$$\partial D_+ \approx \partial D_- \approx S^{n-1}.$$

By Theorem 2.2 the set  $f^{-1}[a, b]$  is diffeomorphic to  $S^{n-1} \times I$ . See Figure 6-2.

Let  $Q_+, Q_- \subset S^n$  be the north and south poles. Let  $B_+, B_-$  be disjoint neighborhoods of  $Q_+, Q_-$  diffeomorphic to  $D^n$  (the two "polar caps") so that, putting  $C = S^n - \text{Int}(B_+ \cup B_-)$ , we have  $C \approx S^{n-1} \times I$  and  $\partial C = \partial B_+ \cup \partial B_-$ .

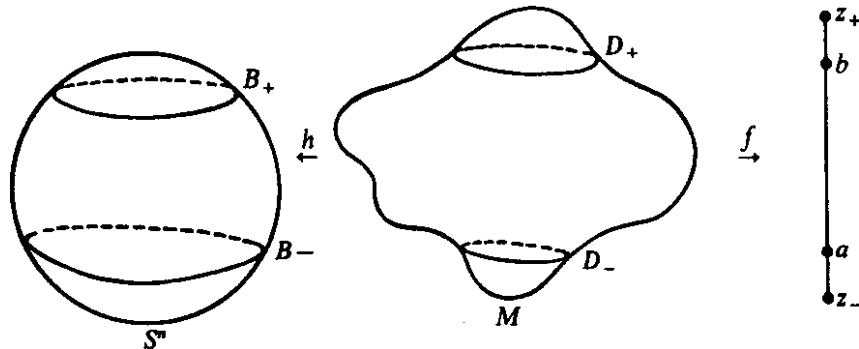

Figure 6-2.

Let  $h_0: D_+ \rightarrow B_+$  be a diffeomorphism. Extend

$$h_0|_{\partial D_+}: \partial D_+ \rightarrow \partial B_+$$

to a diffeomorphism  $(\partial D_+) \times I \rightarrow (\partial B_+) \times I$ . This provides an extension of  $h_0$  to a homeomorphism

$$h_1: D_+ \cup f^{-1}[a, b] \rightarrow B_+ \cup C.$$

It is possible to extend

$$h_1|_{\partial D_-}: \partial D_- \rightarrow \partial B_-$$

to a homeomorphism  $D_- \rightarrow B_-$ . This is the same as extending a homeomorphism  $g_0: S^{n-1} \rightarrow S^{n-1}$  to a homeomorphism  $g: D^n \rightarrow D^n$ , and one can extend *radially*:

$$g(x) = \begin{cases} |x|g_0(x/|x|) & \text{if } x \neq 0 \\ 0 & \text{if } x = 0. \end{cases}$$

Thus  $g$  maps each radial segment  $[0, y], y \in S^{n-1}$ , linearly onto the segment  $[0, g_0(y)]$ .

In this way  $h_1$  is extended to a homeomorphism  $h: M \rightarrow S^n$ .

QED

It is not always possible to find a *diffeomorphism* between  $M$  and  $S^n$ ! In 1956 John Milnor [1] found an example of a manifold which is homeomorphic, but not diffeomorphic, to  $S^7$ . This very surprising result stimulated intensive research into such "exotic spheres" and into the more general problem of finding and classifying all differential structures on a manifold. A great deal is now known, but the problem has not been solved.

### Exercises

1. A vector field  $X$  on  $M$  has *bounded velocity* if there is a complete Riemannian metric on  $M$  such that  $|X(x)|$  is bounded. In this case every maximal solution curve is defined on a closed interval  $J(x)$ . If also  $X$  is tangent to  $\partial M$  then  $X$  is completely integrable.
- \*\*\*2. If a  $C^1$  vector field  $X$  is completely integrable, does  $X$  necessarily have bounded velocity? (See Exercise 1.)
3. Let  $X$  be a  $C^r$  vector field on a manifold  $M, 1 \leq r \leq \infty$ . There is a completely integrable  $C^r$  vector field  $Y$  on  $M$  whose trajectories (considered as subsets) are the same as those of  $X$ .
4. Let  $X$  be a  $C^1$  vector field on a  $\partial$ -manifold  $M$ . If  $x \in \partial M$  and  $J(x) = [0, a]$  or  $[0, a)$  then every neighborhood of  $x$  contains a point  $y \in \partial M$  such that  $X(y) \nmid \partial M$  and  $X(y)$  points inward.
5. Let  $(x, y)$  be local coordinates on the torus  $T = S^1 \times S^1$  corresponding to angular variables on  $S^1$  taken mod  $2\pi$ . For each pair  $\alpha, \beta$  of real numbers not both zero, let  $X_{\alpha, \beta}$  denote the vector field on  $T$  which in  $(x, y)$  coordinates is the constant field  $(\alpha, \beta)$ .
  - (a) If  $\alpha$  and  $\beta$  are linearly dependent over the rational numbers then every trajectory of  $X_{\alpha, \beta}$  is a circle.
  - (b) If  $\alpha$  and  $\beta$  are linearly independent over the rationals then every trajectory of  $X_{\alpha, \beta}$  is dense. In fact:



(c) In case (b), let  $\tau$  be a real number such that  $\tau, \alpha, \beta$  are linearly independent over the rationals. Then for each  $x \in T$  the set  $\{\varphi_n(x) : n \in \mathbb{Z}_+\}$  is dense, where  $\varphi_t$  is the flow of  $X_{\alpha, \beta}$ .

- \*6. On every surface of genus  $p \geq 1$  there is a vector field having a dense trajectory.
- \*\*\*7. Does every  $C^3$  vector field on  $S^3$  necessarily have either a zero or a periodic trajectory? (This has been proved false for  $C^1$  fields by Paul Schweitzer [1] and for  $C^2$  fields by Jenny Harrison [1].)
- \*8. Let  $X$  be a completely integrable  $C^1$  vector field on a manifold  $M$ . Suppose that every positive semi-orbit  $\{\varphi_t(x) : t \geq 0\}$  is dense and that every negative semi-orbit  $\{\varphi_t(x) : t \leq 0\}$  is dense, where  $\varphi$  is the flow generated by  $X$ . Then  $M$  is compact.
- 9. Let  $f : M \rightarrow \mathbb{R}$  be a  $C^1$  function on a Riemannian manifold and let  $V \subset M$  be a submanifold. If  $x \in V$  then  $\text{grad}(f|_V)(x)$  is the image of  $\text{grad} f(x)$  under the orthogonal projection  $M_x \rightarrow V_x$ .
- 10. Theorem 2.2 is true for noncompact  $M$  under the extra hypothesis that  $M$  has a complete Riemannian metric for which  $|\text{grad} f(x)|$  is bounded below. (See Exercise 1.)
- 11. The trick used in the proof of Theorem 2.2, of following integral curves, can often be used to obtain diffeomorphisms. For example, let  $X$  be a  $C^r$  vector field on  $M$ ,  $1 \leq r \leq \omega$ . Let  $V_0, V_1$  be  $C^r$  submanifolds of  $M$  which are transverse to  $X$ . Assume  $\partial V_0 = \partial V_1 = \partial M = \emptyset$ . Suppose that every integral curve through a point of either of the submanifolds intersects the other at a unique point. Then  $V_0$  and  $V_1$  are  $C^r$  diffeomorphic. Moreover if  $r < \omega$  there is a  $C^r$  diffeomorphism of  $M$  which is  $C^r$  isotopic to the identity and which carries  $V_0$  onto  $V_1$ .
- 12. Corollary 2.3 is also true for  $C^1$  maps.
- 13. Theorem 2.4 admits the stronger conclusion that  $M$  is the union of two  $n$ -balls intersecting along their common boundary.
- \*14. Theorem 2.4 can be generalized as follows. If  $M$  admits a function with only two critical points (perhaps degenerate), then the complement of either critical point is diffeomorphic to  $\mathbb{R}^n$  and  $M$  is homeomorphic to  $S^n$ . (Use the gradient flow and a disk around a critical point  $P_-$  to exhibit  $M - P_+$  as an increasing union of open disks; then use Exercise 15 of Section 1.2.)
- \*\*\*15. The conclusions of Exercises 13 and 14 suggest the difficult problem: if  $M - P \approx \mathbb{R}^n$ , is  $M$  the union of two  $n$ -balls intersecting in their common boundary? This is known to be true for all  $n \neq 4$ .

### 3. Passing Critical Levels and Attaching Cells

In order to make  $\partial M$  behave nicely with respect to level surfaces, we shall consider Morse functions  $f : M \rightarrow [a, b]$  of the following type, which we call *admissible*:  $\partial M = f^{-1}(a) \cup f^{-1}(b)$ , and  $a$  and  $b$  are regular values. This has the following implications. Each of  $f^{-1}(a), f^{-1}(b)$  is a union of components of  $\partial M$ . If  $f^{-1}(a)$  or  $f^{-1}(b)$  is empty, the minimum or, respectively, maximum value of  $f$  is taken only at critical points in  $M - \partial M$ .

Theorem 1.2 implies that a compact manifold has an admissible Morse function taking prescribed constant values on boundary components.

Figure 6-3 shows some examples of admissible Morse functions on 2-manifolds, the map being orthogonal projection into the vertical interval  $[a, b]$ . Note that if  $p, q \in [a, b]$  are regular values,  $p < q$ , then restriction of  $f$  to  $f^{-1}[p, q]$  is also admissible (into  $[p, q]$ ).

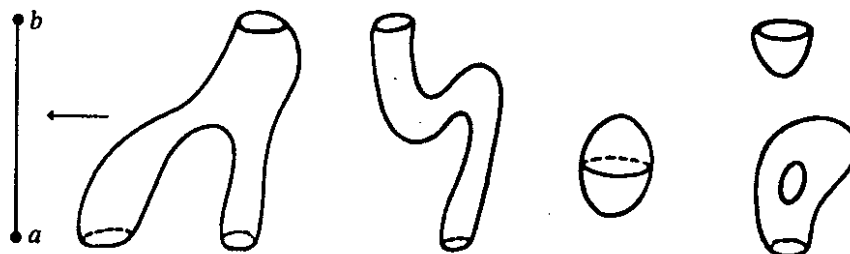

Figure 6-3. Admissible Morse functions.

In the last section we saw that if  $f$  has no critical points then  $M \approx f^{-1}(a) \times I$ . In the following theorem we suppose  $f$  has just one critical point.

By a  $k$ -cell in  $M$  is meant the image of an embedding  $D^k \hookrightarrow M$ .

**3.1. Theorem.** *Let  $M$  be compact and  $f : M \rightarrow [a, b]$  an admissible Morse function. Suppose  $f$  has a unique critical point  $z$ , of index  $k$ . Then there exists a  $k$ -cell  $e^k \subset M - f^{-1}(b)$  such that  $e^k \cap f^{-1}(a) = \partial e^k$ , and there is a deformation retraction of  $M$  onto  $f^{-1}(a) \cup e^k$ .*

*Proof.* Let  $f(z) = c$ ,  $a < c < b$ . To prove the theorem it suffices to prove it for the restriction of  $f$  to  $f^{-1}[a', b']$  for any  $a', b'$  such that  $a < a' < c < b' < b$ , by the regular interval Theorem 2.2 applied to  $f^{-1}[a, a']$  and  $f^{-1}[b, b']$ . Moreover, we can assume  $c = 0$ , replacing  $f$  by  $f(x) - c$  otherwise.

Let  $(\varphi, U)$  be a chart at  $z$  as in Morse's lemma. We write  $\mathbb{R}^n = \mathbb{R}^k \times \mathbb{R}^{n-k}$ , thus  $\varphi$  maps  $U$  diffeomorphically onto an open set  $V \subset \mathbb{R}^k \times \mathbb{R}^{n-k}$ , and

$$f\varphi^{-1}(x, y) = -|x|^2 + |y|^2$$

for  $(x, y) \in V$ . Note that  $\varphi(z) = (0, 0)$ . Put  $g(x, y) = -|x|^2 + |y|^2$ .

Let  $0 < \delta < 1$  be such that  $V$  contains  $\Gamma = B^k(\delta) \times B^{n-k}(\delta)$  where  $B^i(\delta) \subset \mathbb{R}^i$  is the closed ball about 0 of radius  $\delta$ . Give  $M$  a Riemannian metric which agrees in  $\varphi^{-1}(\Gamma)$  with the metric induced by  $\varphi$  from the standard inner product on  $\mathbb{R}^n$ . If  $\varphi(u) = v \in \Gamma$  then

$$D\varphi(u)(\text{grad} f(u)) = \text{grad} g(v).$$

Let  $\varepsilon > 0$  be much smaller than  $\delta$ , say  $\varepsilon < \delta^2/100$ . Put

$$\begin{aligned} B^k &= B^k(\sqrt{\varepsilon}) \times 0 \subset \mathbb{R}^k \times \mathbb{R}^{n-k} \\ &= \{(x, 0) \in \mathbb{R}^k \times \mathbb{R}^{n-k} : |x|^2 \leq \varepsilon\}, \end{aligned}$$

and  $e^k = \varphi^{-1}(B^k)$ .

A deformation of  $f^{-1}[-\varepsilon, \varepsilon]$  to  $f^{-1}(-\varepsilon) \cup e^k$  is made by patching together two deformations. First consider the set

$$\Gamma_1 = D^k(\sqrt{2\varepsilon}) \times D^{n-k}(\sqrt{2\varepsilon}).$$

See Figure 6-4 for the case  $k = 1, n = 2$ . In  $\Gamma_1 \cap g^{-1}[-\varepsilon, \varepsilon]$  a deformation

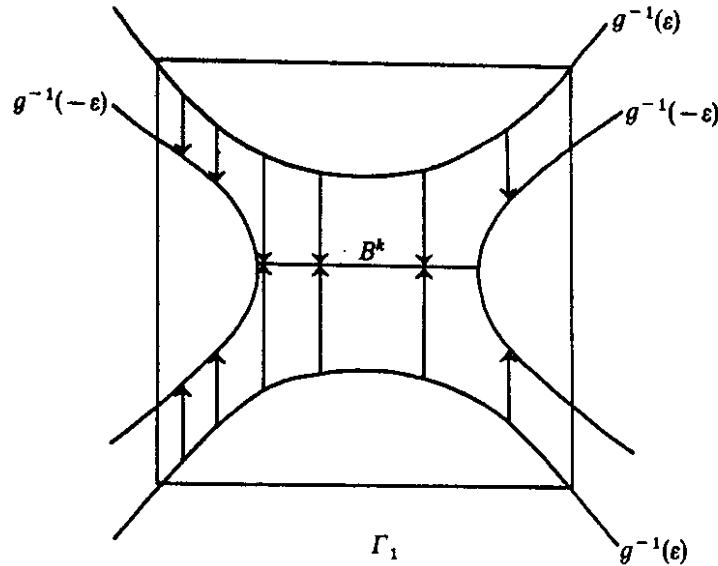

Figure 6-4.

is obtained by moving  $(x, y)$  at constant speed along the interval joining  $(x, y)$  to the point  $(x, y) \in g^{-1}(-\varepsilon) \cup B^k, s \in \mathbb{R}$  where

$$s = s(x, y) = \begin{cases} 0 & \text{if } |x|^2 < \varepsilon \\ \sqrt{|x|^2 - \varepsilon}/|y| & \text{if } |x| \geq \varepsilon. \end{cases}$$

Note that these intervals are closures of solution curves of the vector field  $X(x, y) = (0, -2y)$ . This deformation is transported to  $\varphi^{-1}(\Gamma_1)$  via conjugation by  $\varphi$ .

Outside the set

$$\Gamma_2 = D^k(\sqrt{2\varepsilon}) \times D^{n-k}(\sqrt{2\varepsilon})$$

the deformation moves each point at constant speed along the flow line of the vector field  $-\text{grad } g$  so that it reaches  $g^{-1}(-\varepsilon) \cup B^k$  in unit time. (The speed of each point is the length of its path under the deformation.) See Figure 6-5. This deformation is transported to  $U - \varphi^{-1}(\Gamma_2)$  by  $\varphi$ ; it is then extended over  $M - \varphi^{-1}(\Gamma)$  by following flow lines of  $-\text{grad } f$ . Each such flow line must eventually reach  $f^{-1}(-\varepsilon)$ , for it can never enter  $\Gamma_2$  because  $|x|$  increases and  $|y|$  decreases along flow lines, and  $|\text{grad } f|$

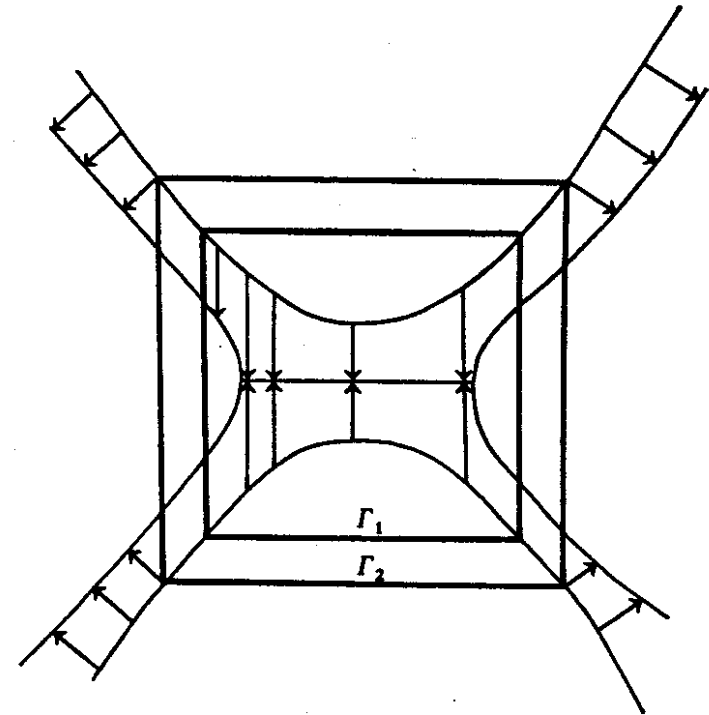

Figure 6-5.

has a positive lower bound in the compact set

$$f^{-1}[-\varepsilon, \varepsilon] - \text{Int } \varphi^{-1}\Gamma_2.$$

To extend the deformation to points of  $\Gamma_2 - \Gamma_1$  it suffices to find a vector field on  $\Gamma$  which agrees with  $X$  in  $\Gamma_1$  and with  $-\text{grad } g$  in  $\Gamma - \Gamma_2$ . Such a field is

$$Y(x, y) = 2(\mu(x, y)x, -y)$$

where the  $C^\infty$  map  $\mu: \mathbb{R}^k \times \mathbb{R}^{n-k} \rightarrow [0, 1]$  vanishes in  $\Gamma_1$  and equals 1 outside  $\Gamma_2$ . It is easy to see that each flow line of  $Y$  which starts at a point of

$$(\Gamma_2 - \Gamma_1) \cap g^{-1}[-\varepsilon, \varepsilon]$$

must reach  $g^{-1}(-\varepsilon)$  because  $|x|$  is non-decreasing along flow lines.

The global deformation of  $f^{-1}[-\varepsilon, \varepsilon]$  into  $f^{-1}(-\varepsilon) \cup e^k$  is obtained by moving each point of  $\Gamma$  at constant speed along the flow line of  $Y$  until it reaches  $g^{-1}(-\varepsilon) \cup B^k$  in unit time and transporting this motion to  $M$  via  $\varphi$ ; while each point of  $M - \varphi^{-1}(\Gamma)$  moves at constant speed along the flow line of  $-\text{grad } f$  until it reaches  $f^{-1}(-\varepsilon)$  in unit time. Of course points on  $f^{-1}(-\varepsilon) \cup e^k$  stay fixed.

If we consider the map  $-f: M \rightarrow [-b, -a]$  instead of  $f$ , we obtain the following result dual to Theorem 3.1:

**3.2. Theorem.** *Let  $f: M \rightarrow [a, b]$  be an admissible Morse function having a unique critical point  $z$ , of index  $k$ . Then there exists an  $(n - k)$ -cell  $e_*^{n-k} \subset M - f^{-1}(a)$  such that  $e_*^{n-k} \cap f^{-1}(b) = \partial e_*^{n-k}$ , and there is a deformation retraction of  $M$  onto  $f^{-1}(b) \cup e_*^{n-k}$ . Moreover  $e_*^{n-k}$  can be chosen so that  $e^k$  (of Theorem 3.1) meets  $e_*^{n-k}$  only at  $z$ , and transversely.*

We speak of these cells  $e^k$  and  $e_*^{n-k}$  as dual to each other. In Figure 6-6 dual pairs of cells are shown.

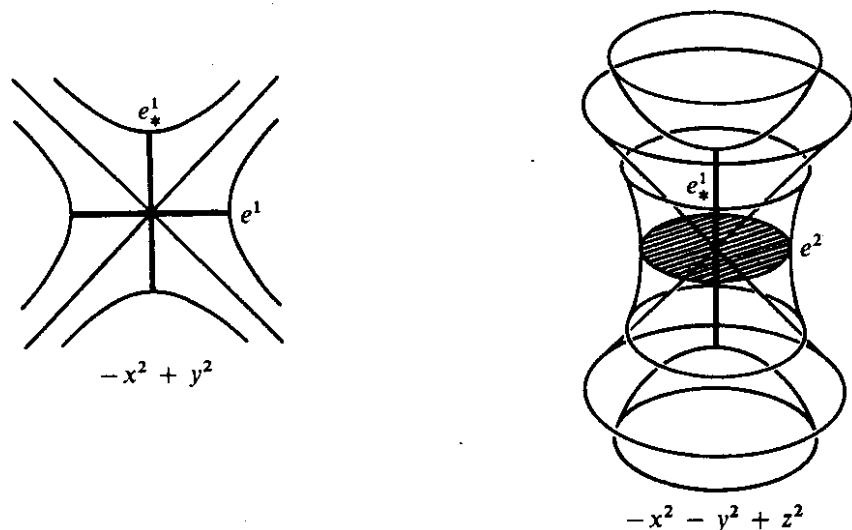

Figure 6-6. Dual cells.

The  $k$ 'th type number of a Morse function  $f: M \rightarrow \mathbb{R}$  is the number  $v_k = v_k(f)$  of critical points of index  $k$ ,  $0 \leq k \leq n = \dim M$ . We say  $f$  has type  $(v_0, \dots, v_n)$ .

**3.3. Theorem.** *Let  $f: M \rightarrow [a, b]$  be an admissible Morse function of type  $(v_0, \dots, v_n)$  on a compact manifold. Suppose  $f$  has just one critical value  $c$ ,  $a < c < b$ . Then there are disjoint  $k$ -cells  $e_i^k \subset M - f^{-1}(b)$ ,  $1 \leq i \leq v_k$ ,  $k = 0, \dots, n$ , such that  $e_i^k \cap f^{-1}(a) = \partial e_i^k$ ; and there is a deformation retraction of  $M$  onto  $f^{-1}(a) \cup \{\bigcup_{i,k} e_i^k\}$ .*

The proof is just like that of Theorem 3.1, using disjoint Morse charts for the different critical points.

We can now prove the celebrated Morse inequalities. These require familiarity with singular homology theory, or any homology theory satisfying the Eilenberg-Steenrod axioms.

The  $k$ 'th singular homology group of the pair  $(X, A)$  with coefficients in the field  $F$  is denoted by  $H_k(X, A; F)$ ; this is a vector space over  $F$  and thus has a dimension  $\lambda_k(X, A; F)$ . When  $F$  is the rational field  $\mathbb{Q}$ , these are called the Betti numbers of  $(X, A)$ . If these numbers are finite, and only finitely many are nonzero, then the homological Euler characteristic

$$\chi(X, A) = \sum_{k=0}^{\infty} (-1)^k \lambda_k(X, A; F)$$

of  $(X, A)$  is defined. When  $X$  is a compact manifold and  $A$  is a compact submanifold then  $\chi(X, A)$  is defined and is independent of the field  $F$ .

**3.4. Theorem.** *Let  $f: M \rightarrow [a, b]$  be an admissible Morse function on a compact manifold, of type  $(v_0, \dots, v_n)$ . Let  $F$  be a field and denote by  $\beta_k$  the dimension of the relative homology group  $H_k(M, f^{-1}(a); F)$ . Then:*

$$(a) \sum_{k=0}^m (-1)^{k+m} v_k \geq \sum_{k=0}^m (-1)^{k+m} \beta_k$$

for  $0 \leq m \leq n$ ; and

$$(b) \sum_{k=0}^n (-1)^k v_k = \sum_{k=0}^n (-1)^k \beta_k = \chi(M, f^{-1}(a)).$$

Before giving the proof we derive some corollaries.

**3.5. Theorem.** *Let  $f: M \rightarrow [a, b]$  be an admissible Morse function on a compact manifold, of type  $(v_0, \dots, v_n)$ . Assume that  $f^{-1}(a) = \emptyset$ . If  $\beta_k$  denotes the dimension of  $H_k(M; F)$  where  $F$  is a field then (a) and (b) of 3.4 are valid. In particular the alternating sum of the type numbers equals the homological Euler characteristic  $\chi(M) = \sum_{k=0}^n (-1)^k \beta_k$ .*

Notice that  $v_k(f) = v_{n-k}(-f)$ . From this follows:

**3.6. Theorem.** *The homological Euler characteristic of a compact odd dimensional manifold without boundary is 0.*

*Proof.* Let  $f: M \rightarrow \mathbb{R}$  be a Morse function of type  $(v_0, \dots, v_n)$ . Let  $a < f(x) < b$  for all  $x \in M$ ; thus  $f: M \rightarrow [a, b]$  is an admissible Morse function. Then Theorem 3.5 applied to  $f$  and  $-f$  gives

$$\begin{aligned} \chi(M) &= \sum_{k=0}^n (-1)^k v_k = \sum_{k=0}^n (-1)^k v_{n-k}(-f) \\ &= (-1)^n \sum_{k=0}^n (-1)^{n-k} v_{n-k}(-f) \\ &= -\chi(M). \end{aligned}$$

The inequalities (a) in Theorem 3.4 can be conveniently arranged as follows. Put  $v_k - \beta_k = \delta_k$ . Then

$$\begin{aligned} \delta_0 &\geq 0 \\ \delta_1 &\geq \delta_0 \geq 0 \\ \delta_2 &\geq \delta_1 - \delta_0 \geq 0 \end{aligned}$$

and in general

$$\delta_{m+1} \geq \delta_m - \delta_{m-1} + \dots + (-1)^m \delta_0 \geq 0.$$

In particular,  $\delta_k \geq 0, k = 0, \dots, n$ . This proves:

**3.7. Theorem.** *In Theorems 3.4 and 3.5,  $v_k \geq \beta_k, k = 0, \dots, n$ .*

We now prove Theorem 3.4. It is convenient to assume that  $f$  separates the critical points, that is,  $f(z_1) \neq f(z_2)$  if  $z_1, z_2$  are distinct critical points. This can be arranged by perturbing  $f$  slightly in disjoint neighborhoods  $U_i \subset M - \partial M$  of the critical points  $z_i$  to get a function  $g: M \rightarrow \mathbb{R}$  of the following type. Outside the union of the  $U_i, g = f$ . In  $U_i$  we have

$$g(x) = f(x) + \varepsilon_i \lambda_i(x)$$

where the  $C^\infty$  map  $\lambda_i: M \rightarrow [0,1]$  has support in  $U_i$  and equals 1 on a neighborhood of  $z_i$ , while  $\varepsilon_i > 0$ . As  $\max \varepsilon_i$  tends to 0,  $g$  tends to  $f$  in  $C^2(M, \mathbb{R})$ . Thus for small  $\varepsilon_i, g$  will be a Morse function having the same critical points as  $f_1$  and these will have the same indices. We can choose the  $\varepsilon_i$  so that  $g$  separates the points  $z_i$ . Therefore we assume  $f$  separates its critical points  $z_1, \dots, z_p$ .

Put  $f(z_i) = c_i$ , and order the  $z_i$  so that  $a < c_1 < \dots < c_p < b$ . Let  $k(i)$  be the index of  $z_i$ . Choose regular values  $a_0, \dots, a_p$  so that

$$a = a_0; \quad a_{i-1} < c_i < a_i; \quad a_p = b.$$

Put  $A = f^{-1}(a_0), X_i = f^{-1}[a_0, a_i]$ . Thus  $X_i$  is obtained from  $X_{i-1}$  by attaching a  $k(i)$ -cell. We denote this by

$$X_i = X_{i-1} \cup e^{k(i)}.$$

Define

$$\alpha(i, j) = \dim H_i(X_j, X_{j-1})$$

where homology groups always have coefficients in the field  $F$ . The excision axiom for homology implies

$$H_i(X_j, X_{j-1}) \approx H_i(D^{k(i)}, \partial D^{k(i)}).$$

Therefore

$$(1) \quad \alpha(i, j) = \begin{cases} 1 & \text{if } i = k(j) \\ 0 & \text{if } i \neq k(j). \end{cases}$$

Define

$$\beta(i, j) = \dim H_i(X_j, A).$$

Since  $X_j$  is obtained from  $A$  by adding cells of dimensions  $\leq n, \beta(i, j) = 0$  for  $i > n$ .

Consider the exact homology sequence of the triple  $(X_j, X_{j-1}, A)$ :

$$0 \rightarrow H_n(X_{j-1}, A) \rightarrow H_n(X_j, A) \rightarrow H_n(X_j, X_{j-1}) \rightarrow H_{n-1}(X_{j-1}, A) \cdots \rightarrow H_0(X_j, X_{j-1}) \rightarrow 0.$$

Exactness implies the vanishing of the corresponding alternating sum of dimensions of the vector spaces in the sequence. Grouping 3 terms at a time in this sum gives:

$$0 = \sum_{i=0}^n (-1)^i [\beta(i, j-1) - \beta(i, j) + \alpha(i, j)].$$

Summing over  $j$  yields

$$\begin{aligned} \sum_{i=0}^n (-1)^i \left[ \sum_{j=1}^n \alpha(i, j) \right] &= \sum_{i=0}^n (-1)^i [\beta(i, n) - \beta(i, 0)] \\ &= \sum_{i=0}^n (-1)^i \beta_i \end{aligned}$$

because  $\beta(i, n) = \beta_i$  and  $\beta(i, 0) = 0$ . Now

$$\sum_{j=1}^n \alpha(i, j)$$

is the number of  $j \in \{1, \dots, n\}$  such that  $k(j) = i$ , which is  $v_i$ . Therefore

$$\sum_{i=0}^n (-1)^i v_i = \sum_{i=0}^n (-1)^i \beta_i.$$

This proves (b) of Theorem 3.4.

The proof of (a) is similar, starting from the exact sequence

$$0 \rightarrow K_{m, j} \rightarrow H_m(X_{j-1}, A) \rightarrow H_m(X_j, A) \rightarrow H_m(X_j, X_{j-1})$$

where the first term is the kernel of  $H_m(X_{j-1}, A) \rightarrow H_m(X_j, A)$  and the rest of the sequence is as before. Let  $\kappa_{m, j} = \dim K_{m, j}$ . Exactness yields

$$\kappa_{m, j} = \sum_{i=0}^m (-1)^{i+m} [\beta(i, j-1) - \beta(i, j) + \alpha(i, j)].$$

Summing over  $j = 1, \dots, n$  gives

$$\sum_{j=1}^n \kappa_{m, j} + \sum_{i=0}^m (-1)^{i+m} \beta_i = \sum_{i=0}^m (-1)^{i+m} \sum_{j=1}^n \alpha(i, j) = \sum_{i=0}^m (-1)^{i+m} v_i$$

which implies (a) since  $\kappa_{m, j} \geq 0$ . The proof of Theorem 3.4 is complete.

For the following important application of Theorem 3.5 let  $M$  be a compact manifold without boundary. Recall that in Chapter 4 we defined the Euler characteristic of  $M$  to be the sum of the indices of zeros of a vector field on  $M$ . We have also defined the *homological* Euler characteristic of  $M$  to be the alternating sum of the Betti numbers of  $M$ . The celebrated *Theorem of Hopf* equates these two characteristics:

**3.8. Theorem.** *The homological Euler characteristic equals the Euler characteristic for a compact manifold without boundary.*

*Proof.* The Euler characteristic can be computed from any vector field  $X$  on  $M$  having finitely many zeros. We choose  $X = \frac{1}{2} \text{grad } f$ , where  $f: M \rightarrow \mathbb{R}$  is a Morse function, and the gradient is taken in a Riemannian metric on  $M$  which, near each critical point, is induced from  $\mathbb{R}^n$  by Morse coordinates.

Let  $p$  be a critical point of index  $k$ . Let  $(x_1, \dots, x_n)$  be Morse coordinates at  $p = (0, \dots, 0)$ . Then

$$f(x) = -x_1^2 - \dots - x_k^2 + x_{k+1}^2 + \dots + x_n^2 + f(p),$$

and

$$X(x) = (-x_1, \dots, -x_k, x_{k+1}, \dots, x_n).$$

Thus  $X$  is the Cartesian product of the vector fields  $Y$  on  $\mathbb{R}^k$ ,  $Z$  on  $\mathbb{R}^{n-k}$  defined by  $Y(y) = -y$ ,  $Z(z) = z$ . An easy computation shows that

$$\text{Ind}_0 X = (\text{Ind}_0 Y)(\text{Ind}_0 Z)$$

and

$$\text{Ind}_0 Y = (-1)^k, \quad \text{Ind}_0 Z = 1.$$

Therefore

$$\text{Ind}_p X = (-1)^k.$$

Therefore the sum of the indices of zeros of  $X$  is  $\sum_{k=0}^n (-1)^k v_k$  where  $v_k$  is the number of critical points of  $f$  of index  $k$ . By Theorem 3.5, this is the homological Euler characteristic.

QED

### Exercises

1. The  $\omega$ -limit set  $L_\omega(x)$  of a point  $x \in M$  for a vector field  $X$  on  $M$  is the set of points of the form  $\lim_{n \rightarrow \infty} \eta(t_n, x)$  where  $\eta$  is the flow of  $X$  and  $t_n \rightarrow \infty$ . The  $\alpha$ -limit set  $L_\alpha(x)$  is defined similarly by letting  $t_n \rightarrow -\infty$  instead of  $\infty$ .

(a) If  $M$  is compact,  $L_\omega(x)$  and  $L_\alpha(x)$  are connected, compact nonempty sets, invariant under the flow.

(b) If  $X = \text{grad } f$  and  $f: M \rightarrow \mathbb{R}$  has isolated critical points then  $L_\omega(x)$  and  $L_\alpha(x)$  each consists of a single critical point.

2. Let  $f: M \rightarrow \mathbb{R}$  be a  $C^{+1}$  Morse function on a compact manifold. Suppose  $M$  has a  $C^\infty$  Riemannian metric which is induced by Morse charts near critical points. Consider the flow of  $\text{grad } f$  for this metric. If  $z$  is a critical point the *stable manifold* of  $z$  (also

called the *inset*) is

$$W_s(z) = \{x \in M : L_\omega(x) = z\}$$

while the *unstable manifold* of  $z$  (also called the *outset*) is

$$W_u(z) = \{x \in M : L_\alpha(x) = z\}.$$

(a)  $W_s(z)$  and  $W_u(z)$  are connected  $C^r$  submanifolds, of dimensions  $k$  and  $n - k$  respectively, where  $k = \text{Ind}(z)$ .

(b)  $W_s(z)$  and  $W_u(z)$  intersect transversely at  $z$  and are otherwise disjoint.

\* (c) If  $\partial M = \emptyset$  then  $W_s(z) \approx \mathbb{R}^{n-k}$  and  $W_u(z) \approx \mathbb{R}^k$ .

\*\* (d) Actually, (a), (b) and (c) are true for any  $C^\infty$  Riemannian metric on  $M$ .

3. A compact  $n$ -manifold is the union of the closures of a finite number of disjoint open  $n$ -cells. [Consider stable manifolds of local minima of a Morse function.]

4. Let  $f: M \rightarrow [a, b]$  be an admissible Morse function on a compact manifold, having a unique critical value  $c$ ,  $a < c < b$ . Let  $z_1, \dots, z_m$  be the critical points of  $f$  and put  $W_s = \bigcup_i W_s(z_i)$ ,  $W_u = \bigcup_i W_u(z_i)$ . (See Exercise 2 for definition of  $W_s$  and  $W_u$ .) Then:

$$M - (W_s \cup W_u) \approx [f^{-1}(a) - W_s] \times I \approx [f^{-1}(b) - W_u] \times I.$$

\*5. Let  $S$  be a compact surface of genus  $p$ .

(a) Every Morse function on  $S$  has at least  $2p + 2$  critical points.

(b) Some Morse function has exactly this number of critical points.

6. Real projective  $n$ -space  $P^n$  can be represented as the quotient space of  $\mathbb{R}^{n+1} - 0$  under the identifications  $(x_0, \dots, x_n) = (cx_0, \dots, cx_n)$  if  $c \neq 0$ . The equivalence class of  $(x_0, \dots, x_n)$  is denoted by  $[x_0, \dots, x_n]$ . Let  $\lambda_0, \dots, \lambda_n$  be distinct nonzero real numbers and define  $f: P^n \rightarrow \mathbb{R}$  by

$$[x_0, \dots, x_n] \mapsto \sum_i \lambda_i x_i^2 / \sum_j x_j^2.$$

(a)  $f$  is a Morse function of type  $(1, 1, \dots, 1)$ . (See also Exercise 1, Section 6.4.)

(b) Sketch the critical points and level surfaces of the composition  $S^n \xrightarrow{p} P^n \xrightarrow{f} \mathbb{R}$ , where  $p$  is the canonical double covering, for  $n = 1, 2, 3$ .

\*7. Let  $f: S^n \rightarrow \mathbb{R}$  be a Morse function invariant under the antipodal map  $x \rightarrow -x$ . Then  $f$  has at least two critical points of each index  $0, 1, \dots, n$ . [Consider the function induced on  $P^n$ . The  $Z_2$  Betti numbers of  $P^n$  are  $1, 1, \dots, 1$ .]

8. Let  $M$  be a compact  $n$ -manifold without boundary and  $f: M \rightarrow \mathbb{R}$  a  $C^2$  map. Suppose every critical point belongs to a nondegenerate critical submanifold (see Exercise 7, Section 6.1). Let  $\mu_k$  denote the sum of the Euler characteristics of the nondegenerate critical submanifolds of index  $k$ . Then the following generalized Morse equality holds:

$$\chi(M) = \sum_{k=0}^n (-1)^k \mu_k.$$

[Let  $g: M \rightarrow \mathbb{R}$  vanish outside tubular neighborhoods of the critical submanifolds, such that  $g$  restricts to a Morse function on the critical submanifolds. One can choose  $g$  so that  $f + g$  is a Morse function whose critical points are precisely those of  $g$  on the critical submanifolds. If  $V$  is a critical submanifold of index  $k$  and  $x \in V$  is a critical point for  $g$  of index  $i$ , then  $x$  has index  $(-1)^{k+i}$  as a critical point of  $f + g$ . The sum of the indices of the critical points of  $f + g$  in  $V$  is thus  $(-1)^k \chi(V)$ . This result is due to R. Bott.]

9. Let  $\varphi: M \rightarrow N$  be a surjective submersion where  $M$  and  $N$  are compact manifolds without boundary. Let  $V = \varphi^{-1}(y)$  for some  $y \in N$ . Then  $\chi(M) = \chi(V)\chi(N)$ . [Let  $g: N \rightarrow \mathbb{R}$  be a Morse function and apply Exercise 8 to  $f = \varphi g: M \rightarrow \mathbb{R}$ .]

10. Let  $\partial_+ M$  be a union of components of the boundary of a compact  $n$ -manifold  $M$ ; put  $\partial_- M = \partial M - \partial_+ M$ . Then

$$\chi(M, \partial_+ M) = \chi(M, \partial_- M).$$

#### 4. CW-Complexes

In this section we assume familiarity with the notion of *CW-complex*.

Briefly, a *CW-complex* is a space  $X$  which can be expressed  $X = \bigcup_{n=0}^{\infty} X_n$  where  $X_0 \subset X_1 \subset \dots, X_0$  is a discrete subset and  $X_n$  is obtained from  $X_{n-1}$  by attaching  $n$ -cells by continuous maps of their boundaries into  $X_{n-1}$ . It is required that a subset of  $X$  is closed provided its intersection with each such cell (image) is closed. If  $X = X_n$  we call  $X$  an  $n$ -dimensional *CW-complex*. If the number of cells is finite,  $X$  is a *finite CW-Complex*.

A *subcomplex*  $A$  of a *CW-complex*  $X$  is a closed subspace  $A$  which is the union of cells of  $X$ . A *CW-pair*  $(X, A)$  consists of a *CW-complex*  $X$  and a subcomplex  $A$ .

**4.1. Theorem.** Let  $M$  be a compact  $n$ -manifold and  $f: M \rightarrow [a, b]$  an admissible Morse function of type  $(v_0, \dots, v_n)$  such that  $\partial M = f^{-1}(b)$ . Then  $M$  has the homotopy type of a finite *CW-complex* having exactly  $v_k$  cells of each dimension  $k = 0, \dots, n$  and no other cells.

*Proof.* The proof is by induction on the number of critical values. If  $c_1$  is the smallest critical value, then  $c_1$  is the absolute minimum of  $f$  because  $f^{-1}(a)$  is empty. Choose  $a < c_1 < a_1$  so that  $c_1$  is the only critical value in  $[a, a_1]$ . Then  $f^{-1}[a, a_1]$  has the homotopy type of a finite discrete set of points by Theorem 3.3; in fact  $f^{-1}[a, a_1]$  is the union of disjoint  $n$ -disks. This starts the induction. The inductive step follows from Theorem 3.3.

QED

Using the same ideas, one can prove the following result. The details are left to the reader.

**4.2. Theorem.** Let  $M$  be a compact  $n$ -dimensional manifold. Then  $(M, \partial M)$  has the homotopy type of a *CW-pair* of dimensions  $\leq n$ .

The restriction that  $M$  be compact is not necessary, but the proof for noncompact manifolds uses triangulation. We outline a proof of a somewhat weaker result:

**4.3. Theorem.** An  $n$ -dimensional manifold has the homotopy type of a *CW-complex* of dimension  $\leq n$ .

*Proof.* One can show that  $M$  and  $M - \partial M$  are homotopy equivalent (for example, by the collaring Theorem 2.1). Hence we can assume  $\partial M = \emptyset$ .

Choose a proper Morse function  $f: M \rightarrow \mathbb{R}_+$ , for example an approximation to the square of a proper map  $M \rightarrow \mathbb{R}$ . Assume  $f$  separates the critical points  $z_1, z_2, \dots$ , which are ordered so that  $f(z_{i+1}) > f(z_i)$ . Choose numbers  $a_i$  so that

$$0 = a_0 < f(z_1) < a_1 < f(z_2) < \dots$$

Note that  $f(z_i) \rightarrow \infty$  since  $f$  is proper and the  $z_i$  are isolated; therefore  $a_i \rightarrow \infty$  also.

From Theorem 4.2, for each integer  $k \geq 1$  there is a *CW-complex*  $X_k$  of dimension  $n$  and disjoint subcomplexes  $Y_k, Z_k \subset X_k$  and a homotopy equivalence

$$w_k: f^{-1}[a_{k-1}, a_k] \rightarrow X_k,$$

taking  $f^{-1}(a_{k-1})$  to  $Y_k$  and  $f^{-1}(a_k)$  to  $Z_k$  by homotopy equivalences. Let  $v_k: Z_k \rightarrow f^{-1}(a_k)$  be a homotopy inverse to  $f: f^{-1}(a_k) \rightarrow Z_k$ . The composition

$$Z_k \xrightarrow{v_k} f^{-1}(a_k) \xrightarrow{w_{k+1}} Y_{k+1}$$

can be approximated by a cellular map  $w_k: Z_k \rightarrow Y_{k+1}$ . A *CW-complex*  $X$  homotopy equivalent to  $M$  is obtained from the disjoint union of the  $X_k$  under the identification of  $x \in Z_k$  with  $w_k(x) \in X_{k+1}$ .

QED

Another extension of Theorem 4.2 is:

**4.4. Theorem.** Let  $M$  be a compact manifold and  $A \subset M$  a compact submanifold,  $\partial A = \partial M = \emptyset$ . Then  $(M, A)$  has the homotopy type of a *CW-pair*.

*Proof.* Let  $N \subset M$  be a closed tubular neighborhood of  $A$ . Thus  $N$  is a closed submanifold with boundary admitting  $A$  as a deformation retract, and  $(M, A)$  has the same homotopy type as  $(M, N)$ . Let  $P = \overline{M - N}$ ; then  $\partial P = \partial N = P \cap N$  and  $P \cap N = M$ . By Theorem 4.2,  $(P, \partial P)$  and  $(N, \partial N)$  have the homotopy type of *CW-complexes*; this implies Theorem 4.4.

QED

Again compactness is an unnecessary restriction. There are also generalizations of Theorem 4.4, to  $\partial$ -manifolds; for example  $A$  can be a closed neat submanifold.

#### Exercises

\*1. Let  $CP^n$  denote complex projective  $n$ -space. Define  $g: CP^n \rightarrow \mathbb{R}$  by the formula

$$g[z_0, \dots, z_n] = \sum \lambda_j |z_j|^2 / \sum |z_j|^2,$$

where  $z_0, \dots, z_n$  are complex homogeneous coordinates on  $CP^n$  and the  $\lambda_j$  are distinct positive numbers. Then  $g$  is a Morse function of type  $(1, 0, 1, 0, \dots, 1, 0, 1)$ . Therefore  $CP^n$  has the homotopy type of a *CW-complex* with 1 cell in even dimensions  $0, 2, \dots, 2n$

and no other cells. Consequently

$$H_k(\mathbb{C}P^n; G) = \begin{cases} G & \text{if } 0 \leq k \leq 2n \text{ and } k \text{ is even} \\ 0 & \text{otherwise} \end{cases}$$

for any coefficient group  $G$ .

2. A *relative CW-complex*  $(X, A)$  consists of a space  $X$  and a closed subspace  $A$  such that  $X = \bigcup_{n=-1}^{\infty} X_n$ , with  $A = X_{-1} \subset X_0 \subset \dots$ , such that  $X_n$  is obtained from  $X_{n-1}$  by attaching  $n$ -cells. If  $f: M \rightarrow [a, b]$  is an admissible Morse function of type  $(v_0, \dots, v_n)$  on a compact manifold  $M$ , then  $(M, f^{-1}(a))$  has the homotopy type of a relative CW-complex having exactly  $v_k$  cells of dimension  $k$ , for each  $k = 0, \dots, n = \dim M$ , and no other cells.

## Chapter 7

### Cobordism

... the theory of "Cobordisme" which has, within the few years of its existence, led to the most penetrating insights into the topology of differentiable manifolds.

—H. Hopf, International Congress of Mathematicians, 1958

Mathematicians are like Frenchmen: whatever you say to them they translate into their own language and forthwith it is something completely different.

—Goethe, *Maximen und Reflexionen*

In this short chapter we present the elementary part of one of the most elegant theories in differential topology, René Thom's theory of cobordism. It was largely for this work that Thom was awarded the Fields Medal in 1958.

We can partition all compact  $n$ -manifolds without boundary into equivalence classes, two manifolds being equivalent if their disjoint union is the boundary of a compact  $(n + 1)$ -manifold. The set  $\mathcal{R}^n$  of equivalence classes becomes an abelian group under the operation of disjoint union. An analogous construction with oriented manifolds produces an abelian group  $\Omega^n$ . Thom [1] set himself (and largely solved) the problem of computing these *cobordism groups*. Although their definition is very simple, it is not at all obvious how to compute them, or even to determine their cardinality.

Thom's work falls into two parts: first, proving that the cobordism groups are isomorphic to certain homotopy groups; and second, computing these homotopy groups. The second step requires a good deal of algebraic topology and we cannot go into it; it is the first step we are concerned with. Even though the proof yields no explicit calculations, it provides new insights into the connections between manifolds, vector bundles, homotopy and transversality.

#### 1. Cobordism and Transversality

Two compact manifolds  $M_0, M_1$  are called *cobordant*, denoted by  $M_0 \sim M_1$ , if there is a compact manifold  $W$  such that  $\partial W \approx M_0 \times 0 \cup M_1 \times 1$ . Speaking loosely, this means that the disjoint union of  $M_0$  and  $M_1$  is the boundary of  $W$ . We call  $W$  a cobordism from  $M_0$  to  $M_1$ . It is easy to see that

for each dimension  $n$  this defines an equivalence relation, called *cobordism*, on the class of compact  $n$ -manifolds without boundary. The set of cobordism classes is denoted by  $\mathfrak{R}^n$ ; the cobordism class of  $M$  is  $[M]$ .

An analogous equivalence relation, *oriented cobordism*, is defined for oriented manifolds. Let  $\omega_i$  be an orientation of  $M_i$ ; then  $(M_0, \omega_0)$  and  $(M_1, \omega_1)$  are *cobordant* if there is a compact oriented manifold  $(W, \theta)$  and an orientation preserving diffeomorphism

$$(\partial W, \partial\theta) \approx (M_0 \times 0, -\omega_0) \cup (M_1 \times 1, \omega_1).$$

The set of these equivalence classes is denoted by  $\mathfrak{Q}^n$ .

**1.1. Theorem.** *The operation of disjoint union makes  $\mathfrak{R}^n$  and  $\mathfrak{Q}^n$  into abelian groups.*

*Proof.* First of all, diffeomorphic manifolds are cobordant: if  $M_0 \approx M_1$  then

$$M_0 \times 0 \cup M_1 \times 1 \approx \partial(M_0 \times I)$$

(taking orientations into account where appropriate). The associative and commutative laws follow easily. The zero element of the group is  $[V]$  for any  $V$  which is the boundary of some compact manifold  $W$ . For, taking  $M \times I$  and  $W$  disjoint, we have

$$(M \times 0 \cup V) \cup (M \times 1) = \partial(M \times I \cup W).$$

Thus  $M \cup V \sim M$ . (We could take  $V = \emptyset$ .) The inverse of  $[M]$  is  $[M]$ ; the inverse of  $[M, \omega]$  is  $[M, -\omega]$ , as is seen by looking at  $M \times I$ .

QED

We have defined two sequences of abelian groups, the *oriented* and *non-oriented cobordism groups*. How can they be computed? Since we know all manifolds of dimension 0 or 1, the computation is easy in this case (Exercise 3); and it is also simple in dimension 2 once we have classified surfaces. But this kind of head-on attack will not get very far.

For any topological problem it is always a good idea to try to bring maps into play. Now we have already seen a useful connection between maps and manifolds: if  $f: V \rightarrow N$  is transverse to a submanifold  $A \subset N$  then  $f^{-1}(A)$  is a submanifold of  $V$ . If we fix  $V, N$  and  $A$ , and let  $f$  vary, we obtain a collection of submanifolds of  $V$ .

Once we consider maps, we should think about homotopy. A natural question is: if  $f, g: V \rightarrow N$  are homotopic, how are  $f^{-1}(A)$  and  $g^{-1}(A)$  related? The following simple result is the key to cobordism:

**1.2. Lemma.** *Let  $V, N$  be manifolds without boundary and  $A \subset N$  a closed submanifold without boundary. Assume  $V$  is compact. If  $f, g: V \rightarrow N$  are homotopic maps, both of which are transverse to  $A$ , then the manifolds  $f^{-1}(A), g^{-1}(A)$  are cobordant.*

*Proof.* There is a homotopy  $H: V \times I \rightarrow N$  from  $f$  to  $g$ , which we can choose transverse to  $A$ . Then  $H^{-1}(A)$  is a cobordism from  $f^{-1}(A)$  to  $g^{-1}(A)$ .

QED

We thus obtain a map from the homotopy set  $[V, N]$  to  $\mathfrak{R}^n$ , where  $n = \dim V - \dim N + \dim A$ . If we want to capture all of  $\mathfrak{R}^n$  in this way, we must choose  $V$  to be a manifold in which all  $n$ -manifolds can be embedded. Thus we take  $V = S^{n+k}$  with large  $k = \dim N - \dim A$ . We now have a map  $[S^{n+k}, N] \rightarrow \mathfrak{R}^n$ .

Suppose  $f: S^{n+k} \rightarrow N$  is transverse to  $A$ . What can we say about the submanifold  $f^{-1}(A) = M \subset S^{n+k}$ ? A most important fact is that *the normal bundle of  $M$  in  $S^{n+k}$  is the pullback under  $f$  of the normal bundle of  $A$  in  $N$* . For by the definition of transversality,  $Tf$  induces a vector bundle map of algebraic normal bundles:

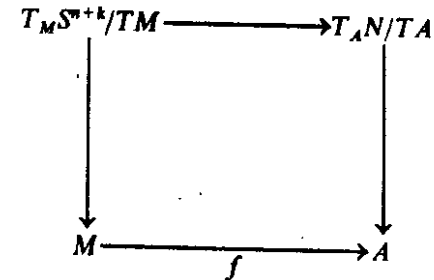

It follows that the submanifold  $A \subset N$  must have the property that the normal bundle of any  $M^n \subset S^{n+k}$  can be pulled back from the normal bundle of  $A$  by some map  $M \rightarrow A$ . Fortunately we have already constructed a pair  $(N, A)$  with this property, namely  $(E_{s,k}, G_{s,k})$  for  $s > n + k$ . Here  $G_{s,k}$  is the Grassmann manifold of  $k$ -planes in  $\mathbb{R}^s$  and  $E_{s,k}$  is the total space of the universal bundle  $\gamma_{s,k} \rightarrow G_{s,k}$  (see Section 4.3). As usual the base space is identified with the zero section, so that  $G_{s,k} \subset E_{s,k}$ .

For ease of notation we put  $E = E_{s,k}, G = G_{s,k}$ . Given a compact  $n$ -dimensional submanifold  $M \subset S^{n+k}$  without boundary, let  $U \subset S^{n+k}$  be a tubular neighborhood of  $M$ . Then, by Theorem 3.4 of Chapter 4, there is a map of vector bundles

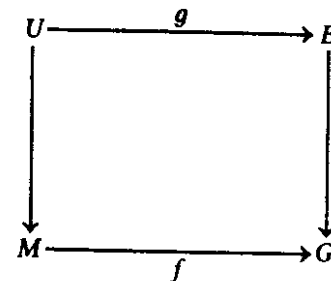



At this stage a new problem arises: we want  $g$  defined on all of  $S^{n+k}$ , not merely on the subset  $U$ . Moreover the extended map must not map any new points into  $G$ , since it is essential that  $g^{-1}(G) = M$ .

Simple examples show that such an extension may not be possible. At this point Thom introduces a *deus ex machina*: he adds a "point at infinity" to  $E$  and maps  $S^{n+k} - U$  to the new point! This stroke of genius completely solves the problem; it only remains to work out the technical details. We do this in the next section.

**Exercises**

1. The operation of cartesian product of manifolds induces bilinear maps

$$\Omega^i \times \Omega^j \rightarrow \Omega^{i+j}.$$

These pairings are associative, and commutative in the sense of graded rings: if  $\alpha \in \Omega^i$ ,  $\beta \in \Omega^j$  the  $\alpha\beta = (-1)^{i+j}\beta\alpha$ . There are similar bilinear pairings

$$\mathfrak{N}^i \times \mathfrak{N}^j \rightarrow \mathfrak{N}^{i+j}$$

which are strictly commutative.

2. Every element of  $\mathfrak{N}^i$  has order 2.
3.  $\Omega^0 = \mathbb{Z}$ ,  $\mathfrak{N}^0 = \mathbb{Z}_2$  and  $\Omega^1 = \mathfrak{N}^1 = 0$ .
4. Let  $n \geq 0$  be an even integer. The "mod 2 Euler characteristic" defines a surjective homomorphism  $\mathfrak{N}^n \rightarrow \mathbb{Z}_2$ .
5. An orientable surface of genus  $p \geq 0$  (as defined in Exercise 12, Section 1.3) is the boundary of a compact oriented 3-manifold.

**2. The Thom Homomorphism**

Let  $\xi = (p, E, B)$  be a vector bundle over a compact manifold  $B$  without boundary. The *one-point compactification*  $E^*$  of  $E$  is the space  $E^* = E \cup \{\infty\}$  where  $\infty$  is a point not in  $E$ . Neighborhoods of  $\infty$  are complements in  $E^*$  of compact subsets of  $E$ . We also call  $E^*$  the *Thom space* of the vector bundle  $\xi$ .

A fundamental property of  $E^*$  is that  $E^* - B$  is a contractible space. A contraction to  $\infty$  is given by the homotopy

$$(x, t) \mapsto \begin{cases} (E^* - B) \times I \rightarrow E^* - B \\ \left(\frac{1+t}{1-t}\right)x, & \text{if } 0 \leq t < 1, x \neq \infty \\ \infty, & t = 1 \text{ or } x = \infty. \end{cases}$$

From the homotopy extension theorem we obtain:

- 2.1. **Lemma.** Let  $Y$  be a closed subset of a manifold  $Q$ . Then two maps  $Q \rightarrow E^* - B$  which agree on  $Y$  are homotopic rel  $Y$ .

Now let  $Q$  be a manifold and  $g: Q \rightarrow E^*$  a map. We say that  $g$  is in *standard form* if there is a submanifold  $M \subset Q$  and a tubular neighborhood  $U \subset Q$  of  $M$  such that  $U = g^{-1}(E)$ ,  $M = g^{-1}(B)$ , and the diagram

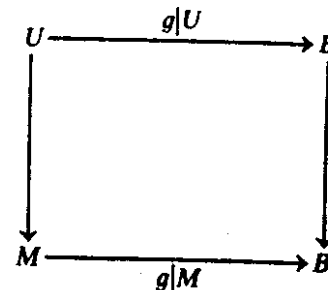

is a vector bundle map. This implies:  $g \upharpoonright B$  and  $g(Q - U) = \infty$ .

- 2.2. **Lemma.** Let  $Q$  be a compact manifold and  $B$  a compact manifold without boundary. Then every map  $f: Q \rightarrow E^*$  is homotopic to a map in standard form.

*Proof.* By a preliminary homotopy we assume  $f \upharpoonright B$ . Put  $M = f^{-1}(B)$ ; let  $U \subset f^{-1}(E)$  be a tubular neighborhood of  $M$  and  $D \subset U$  a disk subbundle. By Theorem 4.6.7 we can further assume that  $f$  agrees in  $D$  with a vector bundle map  $\phi: U \rightarrow E$ . Define a map

$$h: Q \rightarrow E^* \\ h = \begin{cases} \phi & \text{on } U \\ \infty & \text{on } Q - U. \end{cases}$$

Then  $h$  agrees with  $f$  on  $D$ , and  $h$  is in standard form. Since  $h$  and  $f$  agree on  $\partial D$ , and both map  $Q - \text{int } D$  into the contractible space  $E^* - B$ , it follows from Lemma 2.1 that  $f \simeq h$ .

QED

Let  $E_{s,k} \rightarrow G_{s,k}$  be the Grassmann bundle; put  $E = E_{s,k}$ ,  $G = G_{s,k}$ .

Let  $\pi_{n+k}(E^*)$  denote the  $(n+k)$ th homotopy group of  $E^* = E_{s,k}^*$ ; the base point is  $\infty$ . The homotopy class of  $f: S^{n+k} \rightarrow E^*$  is denoted by  $[f]$ .

We now define the *Thom homomorphism*  $\tau(n; k, s) = \tau: \pi_{n+k}(E^*) \rightarrow \mathfrak{N}^n$  as follows. Let  $\alpha \in \pi_{n+k}(E^*)$ . By the transversality theorem there exists  $f \in \alpha$  such that  $f: S^{n+k} \rightarrow E^*$  is transverse to  $G$  (or more precisely,  $f|(S^{n+k} - f^{-1}(\infty))$  is transverse to  $G$ ). By Lemma 1.2 the cobordism class of the manifold  $f^{-1}(G)$  is independent of the choice of  $f$ . We define  $\tau(\alpha) = [f^{-1}(G)]$ . Thus  $\tau(\alpha) = [f^{-1}(G)]$  where  $f \in \alpha$ ,  $f \upharpoonright G$ .

To see that  $\tau$  is additive, let  $\alpha, \beta \in \pi_{n+k}(E^*)$ . According to one of the definitions of addition in homotopy groups, we can define  $\alpha + \beta$  as follows. Choose maps  $f \in \alpha$ ,  $g \in \beta$ , such that  $f$  maps the lower hemisphere of  $S^{n+k}$  to  $\infty$  and  $g$  maps the upper hemisphere to  $\infty$ . Then  $\alpha + \beta$  is the class of the

map  $h$  which equals  $f$  on the upper hemisphere and  $g$  on the lower hemisphere. We may assume that  $f$ ,  $g$  and  $h$  are transverse to  $G$ . It is clear that  $h^{-1}(G)$  is the disjoint union of  $f^{-1}(G)$  and  $g^{-1}(G)$ , since these are in disjoint open hemispheres. Therefore

$$\begin{aligned}\tau(\alpha + \beta) &= [h^{-1}(G)] \\ &= [f^{-1}(G) \cup g^{-1}(G)] \\ &= [f^{-1}(G)] + [g^{-1}(G)] \\ &= \tau(\alpha) + \tau(\beta).\end{aligned}$$

For oriented manifolds there is defined a similar Thom homomorphism

$$\tilde{\tau}: \pi_{n+k}(\tilde{E}^*) \rightarrow \Omega^n.$$

Here  $\tilde{E} = \tilde{E}_{s,k}$  is the total space of the vector bundle  $\tilde{\gamma}_{s,k}$  defined as follows. The base space  $\tilde{G} = \tilde{G}_{s,k}$  is the manifold of oriented  $k$ -planes in  $\mathbb{R}^s$ ; an element of  $\tilde{G}$  is a pair  $(P, \omega)$  where  $P \in G$  and  $\omega$  is an orientation of the  $k$ -plane  $P$ . Thus  $\tilde{G}$  is a double covering of  $G$ .

The vector bundle  $\tilde{\gamma}_{s,k}$  is defined as the pullback of  $\gamma_{s,k}$  by the covering map  $\tilde{G} \rightarrow G$ ,  $(P, \omega) \mapsto P$ . Thus an element of  $\tilde{E}$  is a triple  $(P, \omega, x)$  comprising a  $k$ -plane  $P \subset \mathbb{R}^s$ , an orientation  $\omega$  of  $P$ , and a vector  $x \in P$ . The bundle projection of  $\tilde{\gamma}_{s,k}$  is the map

$$\tilde{E} \rightarrow \tilde{G}, \quad (P, \omega, x) \mapsto (P, \omega).$$

Notice that the bundle  $\tilde{\gamma}_{s,k}$  has a canonical orientation: the fibre over  $(P, \omega)$  is oriented by  $\omega$ .

The oriented Thom homomorphism  $\tilde{\tau}$  is defined as follows. Let  $\alpha \in \pi_{n+k}(\tilde{E}^*)$ . Then  $\tilde{\tau}(\alpha) = [f^{-1}(\tilde{G}), \theta]$  where

$$f: S^{n+k} \rightarrow \tilde{E}^*, \quad f \upharpoonright G, \quad f \in \alpha$$

and the orientation  $\theta$  of the manifold  $M = f^{-1}(\tilde{G}) \subset S^{n+k}$  is defined as follows. The normal bundle  $\nu$  of  $M$  is the pullback of the normal bundle of  $\tilde{G}$  in  $\tilde{E}$ , which is just  $\tilde{\gamma}_{s,k}$ . Orient  $\nu$  by the pullback of the canonical orientation of  $\tilde{\gamma}_{s,k}$ . Give  $S^{n+k}$  its standard orientation  $\sigma$ ; and then give  $M$  the unique orientation  $\theta$  such that  $\theta \oplus \nu = \sigma$  on  $T_M S^{n+k}$ .

The following is the *fundamental theorem of cobordism*:

**2.3. Theorem (Thom).** *The Thom homomorphisms  $\tau(n; k, s)$  and  $\tilde{\tau}(n; k, s)$  are:*

- (a) *surjective if  $k > n$  and  $s \geq k + n$ ;*
- (b) *injective (and hence bijective) if  $k > n + 1$  and  $s \geq k + n + 1$ .*

*Proof.* For simplicity we deal only with the unoriented case. To prove (a) let  $[M^n] \in \mathfrak{R}^n$ . We can assume  $M^n \subset S^{n+k}$  by Whitney's embedding theorem. Let  $U \subset S^{n+k}$  be a tubular neighborhood of  $M^n$ . By 4.3.4 there is a vector bundle map  $U \rightarrow E_{s,k}$ , because  $s \geq k + n$ . Extend this to the map  $g: S^{n+k} \rightarrow E_{s,k}^*$  which sends  $S^{n+k} - U$  to  $\infty$ . Clearly  $g \upharpoonright G_{s,k}$  and  $g^{-1}(G_{s,k}) = M^n$ . Hence  $\tau([g]) = [M^n]$ .

To prove (b), suppose  $g: S^{n+k} \rightarrow E_{s,k}^*$  is such that  $\tau([g]) = 0 \in \mathfrak{R}^n$ . We may assume  $g$  is in standard form by Theorem 2.2. Put  $g^{-1}(G_{s,k}) = M^n$ . Then  $\tau([g]) = [M^n] = 0$ , so that  $M$  bounds a compact manifold  $W^{n+1}$ . The assumption  $k > n + 1$  implies that the inclusion  $M^n \rightarrow S^{n+k}$  extends to a neat embedding  $W^{n+1} \rightarrow D^{n+k+1}$ .

The tubular neighborhood  $U \subset S^{n+k}$  of  $M^n$  (used for the standard form of  $g$ ) extends to a tubular neighborhood  $V \subset D^{n+k+1}$  of  $W^{n+1}$  (see Theorem 4.6.4). By Theorem 4.3.4 the bundle map  $g: U \rightarrow E_{s,k}$  extends to a bundle map  $h: V \rightarrow E_{s,k}$ , since  $s \geq k + (n + 1)$ . We extend  $h$  over all of  $D^{n+k+1}$  by mapping  $D^{n+k+1} - V$  to  $\infty$ . Since  $h|_{S^{n+k}} = g$  it follows that  $[g] = 0$ .

QED

As was mentioned earlier we cannot go into the actual computation of cobordism groups, nor can we discuss their important applications; but the following remarks may indicate some of the power of Thom's theory.

It is not hard to show that  $E^*$  and  $\tilde{E}^*$  are finite simplicial complexes. It follows from the simplicial approximation theorem that they have countable homotopy groups. Therefore the groups  $\mathfrak{R}^n$  and  $\Omega^n$  are countable—a conclusion by no means obvious from their definitions. Using algebraic topology it can be shown that in fact these groups are *finitely generated*. This means that there is a finite set  $\mathcal{S}$  of  $n$ -manifolds having the following property: every compact  $n$ -manifold without boundary is cobordant to the disjoint union of a finite number of copies of elements of  $\mathcal{S}$ .

Much sharper results on the nature of the cobordism groups are known. As a sample we quote without proof a truly remarkable theorem of Thom:

**2.4. Theorem.** *Let  $n$  be a positive integer.*

- (a) *If  $n$  is not divisible by 4 then the oriented cobordism group  $\Omega^n$  is finite.*
- (b) *If  $n$  is divisible by 4, say  $n = 4k$ , then  $\Omega^n$  is a finitely generated abelian group whose rank is  $\pi(k)$ , the number of partitions of  $k$ . Moreover:*
- (c) *A basis for the torsion-free part of  $\Omega^{4k}$  consists of all products of the form  $CP^{2j_1} \times \cdots \times CP^{2j_r}$  with  $j_1 + \cdots + j_r = k$  and  $1 \leq j_1 \leq \cdots \leq j_r \leq k$ .*

Thus the differentiable problem of computing cobordism groups has been largely reduced to the combinatorial problem of computing  $\pi(k)$ . This latter problem is classical; unfortunately it has not been solved.

### Exercises

1. (a) The space  $E_{n,1}^*$  is homeomorphic to  $P^n$ .
- (b) The space  $\tilde{E}_{n,1}^*$  is homeomorphic to the space obtained by identifying two points of  $S^n$ .
- (c) The space  $E_{n,n}^*$  is homeomorphic to  $S^n$ .
2. Let  $E$  be the total space of a  $k$ -plane bundle over a compact manifold.
  - (a) If  $M$  is a manifold of dimension less than  $k$ , every map  $M \rightarrow E^*$  is homotopic to a constant.
  - (b) The inclusion  $\mathbb{R}^k \rightarrow E$  of a fibre extends to a map  $S^k \rightarrow E^*$  which is not homotopic to a constant.

3. Two  $n$ -dimensional submanifolds  $M_0, M_1$  of a compact manifold  $V$  are called  $V$ -cobordant if there is a compact submanifold  $W \subset V \times I$  such that

$$\partial W = M_0 \times 0 \cup M_1 \times 1.$$

This is an equivalence relation; the set of equivalence classes is denoted  $\mathfrak{R}^n(V)$ .

\* (a) Let  $\dim V = n + k$ . The natural map  $\tau_v: [V, E_{s,k}^*] \rightarrow \mathfrak{R}^n(V)$  is surjective if  $k > n$ ,  $s \geq k + n$  and bijective if  $k > n + 1, s \geq k + n + 1$ .

(b) Under what assumptions does the operation "disjoint union" make  $\mathfrak{R}^n(V)$  a semi-group? A group?

(c)  $\mathfrak{R}^n(S^{n+k})$  is a group for all  $n, k$ .

4. Let  $V$  be a Riemannian manifold. A framed submanifold  $(M^n, F)$  of  $V^{n+k}$  is a compact submanifold  $M^n \subset V$ , plus a family  $F = (F_1, \dots, F_k)$  of sections of  $\tau_M V$  such that  $(F_1(x), \dots, F_k(x))$  are independent vectors spanning a subspace transverse to  $M_x$ , for all  $x \in M$ . Two framed submanifolds  $(M_0, F), (M_1, F)$  are framed cobordant if there is a framed submanifold  $(W, G) \subset V \times I$  such that  $\partial W = M_0 \times 0 \cup M_1 \times 1$ , and  $G|_{\partial W} = F \cup F'$ . The resulting set of equivalence classes is denoted  $F^n(V^{n+k})$ .

(a) There is a natural map

$$\pi: [V^{n+k}, S^k] \rightarrow F^n(V^{n+k}).$$

[Imagine  $S^k = (\mathbb{R}^k)^* = (E_{k,k})^*$ .]

(b)  $\pi$  is an isomorphism for all  $k, n$ .

(c) When  $k = 0$  and  $V^n$  is connected and oriented, there is a "degree" isomorphism  $F^n(V^n) \approx \mathbb{Z}$ . Thus we recapture the isomorphism  $\text{deg}: [V^n, S^0] \approx \mathbb{Z}$ .

5. Let  $\eta = (p, E, B)$  be a fixed vector bundle over a compact manifold  $B, \partial B = \emptyset$ . An  $\eta$ -submanifold  $(M, f) \subset V$  of a manifold  $V$  is a pair  $(M, f)$  where  $M \subset V$  is a compact submanifold and  $f$  is a bundle map from the normal bundle of  $M$  to  $\eta$  (this requires  $\dim \eta = \dim V - \dim M$ ). Two  $\eta$ -submanifolds  $(M_1, f_1) \subset V$  are  $\eta$ -cobordant if there is an  $\eta$ -submanifold  $(W, f) \subset V \times I$  such that  $\partial(W, f) = (M_0, f_0) \times 0 \cup (M_1, f_1) \times 1$  (using an obvious notation). The set of  $\eta$ -cobordism classes corresponds bijectively to the homotopy set  $[V, E^*]$ .

6. The bordism group  $\Omega^n(X)$  of a space  $X$  is defined as follows. An element of  $\Omega^n(X)$  is an equivalence class  $[f, M]$  of maps  $f: M \rightarrow X$  where  $M$  is a compact oriented  $n$ -manifold without boundary, two maps being equivalent if they extend to a map defined on an oriented cobordism between their domains. Taking  $X =$  a point gives  $\Omega^n$ . A homotopy class of maps  $g: X \rightarrow Y$  induces a homomorphism of abelian groups  $g_*: \Omega^n(X) \rightarrow \Omega^n(Y)$ , by composition with maps  $f: M \rightarrow X$ .

\*7. There are natural homomorphisms  $\Omega^n(X) \rightarrow H_n(X)$ . For  $n = 1$  these are isomorphisms.

8. There is a bilinear pairing

$$\Omega^n(X) \times \Omega^m(X) \rightarrow \Omega^{n+m-p}(X)$$

induced by intersection of maps, when  $X$  is an oriented  $p$ -dimensional manifold.

## Chapter 8

### Isotopy

Let us think, say, of a surface or a solid made of rubber, with figures marked upon it. What is preserved in these figures if the rubber is arbitrarily distorted without being torn?

—F. Klein, *Elementary Mathematics from an Advanced Standpoint*, 1908

In this chapter we investigate more thoroughly the notion of isotopy, introduced earlier for the tubular neighborhood theorem.

Intuitively speaking, we call two embeddings  $f, g: V \hookrightarrow M$  isotopic if one can be deformed to the other through embeddings; such a deformation is called an isotopy. By itself this relation is not very useful. However, it is usually true that the isotopy can be realized by a diffeotopy of  $M$ , that is, by a one-parameter family  $h_t$  of diffeomorphisms of  $M$  such that  $h_0 = 1_M$  and  $h_1 f = g$ . In this case  $f$  and  $g$  embed  $V$  in  $M$  "in the same way". It follows, for example, that if  $f$  extends to an embedding  $F: W \hookrightarrow M$ , where  $W \supset V$ , then  $g$  also extends to an embedding of  $W$ , namely  $h_1 F$ .

Thus in order to extend an embedding, it suffices to prove it is isotopic to an extendable embedding. This extension technique is one of the main uses of isotopy.

In Section 8.1 we prove the fundamental isotopy extension Theorem 1.3, along with several variations and applications. Section 8.2 applies these results to the question of differential structure on the union of two smooth manifolds which have been glued together along boundary components. In Section 8.3 special isotopies are constructed for embeddings of disks, the point being that there is only one way, up to isotopy and orientation, of embedding a disk in a connected manifold. Diffeotopies of the circle are also treated.

These results will be used in Chapter 9 to classify compact surfaces. They are a basic tool in any attempt to analyze manifolds or embeddings. Several applications are given in the exercises.

#### 1. Extending Isotopies

Let  $V$  and  $M$  be manifolds. Recall that an isotopy from  $V$  to  $M$  is a map  $F: V \times I \rightarrow M$  such that for each  $t \in I$  the map

$$F_t: V \rightarrow M, \quad x \mapsto F(x, t)$$

is an embedding. Intuitively, an isotopy is a smooth 1-parameter family of embeddings.

The *track* of the isotopy  $F$  is the embedding

$$\begin{aligned} \hat{F}: V \times I &\rightarrow M \times I, \\ (x,t) &\mapsto (F(x,t),t). \end{aligned}$$

Notice that  $F$  is *level-preserving*—it preserves the coordinate  $t$ . Every level-preserving embedding is the track of an isotopy.

If  $F: V \times I \rightarrow M$  is an isotopy we call the two embeddings  $F_0$  and  $F_1$  *isotopic*; we also say that  $F$  is an *isotopy of  $F_0$* . If  $V$  is a submanifold of  $M$  and  $F_0$  is the inclusion, we call  $F$  an *isotopy of  $V$  in  $M$* . When  $V = M$  and each  $F_t$  is a diffeomorphism, and  $F_0 = 1_M$ , then  $F$  is called a *diffeotopy* or an *ambient isotopy*.

There is an important connection between diffeotopies of  $M$  and vector fields on  $M \times I$ . Let  $\hat{F}: M \times I \rightarrow M \times I$  be the track of a diffeotopy  $F$ , so that  $\hat{F}$  is a level-preserving diffeomorphism. Each point of  $M \times I$  belongs to a unique arc  $\hat{F}(x \times I)$  for some  $x \in M$ . The tangent vectors to these arcs form a nonvanishing vector field  $X_F$  on  $M \times I$ , which is carried by the projection  $M \times I \rightarrow I$  to the constant positive unit vector field on  $I$ . Thus there is a map  $H: M \times I \rightarrow TM$  such that

$$X_F(y,t) = (H(y,t),1) \in M_y \times \mathbb{R} = T_{(y,t)}(M \times I).$$

The isotopy  $F$  is the flow  $\Phi$  of  $X_F$  applied to  $M \times 0$ :

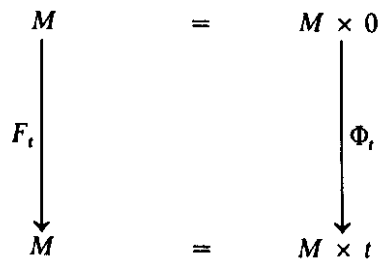

The *horizontal part*  $H$  of  $X_F$  is a special case of a *time-dependent vector field* on  $M$ . By this is meant any map  $G: M \times I \rightarrow TM$  such that  $G(x,t) \in M_x$ ; we also require that  $G$  map  $\partial M \times I$  into  $T(\partial M)$ .

Not every time-dependent vector field  $G$  comes from a diffeotopy, for there is no guarantee that the flow of the corresponding vector field  $X$  on  $M \times I$  is defined for all  $t \in I$ . The following diagram (Figure 8-1) shows the solution curves of a vector field on  $\mathbb{R} \times I$  which can be scaled to have vertical component 1; but *no* solution curve goes from  $\mathbb{R} \times 0$  to  $\mathbb{R} \times 1$ !

Since time-dependent vector fields are easy to construct, it is useful to have a criterion which guarantees that they generate isotopies. One such condition is the following. A time-dependent vector field  $G: M \times I \rightarrow TM$  has *bounded velocity* if  $M$  has a complete Riemannian metric such that  $|G(x,t)| < K$  for some constant  $K$ . (Compare Exercise 1 of Section 6.2.)

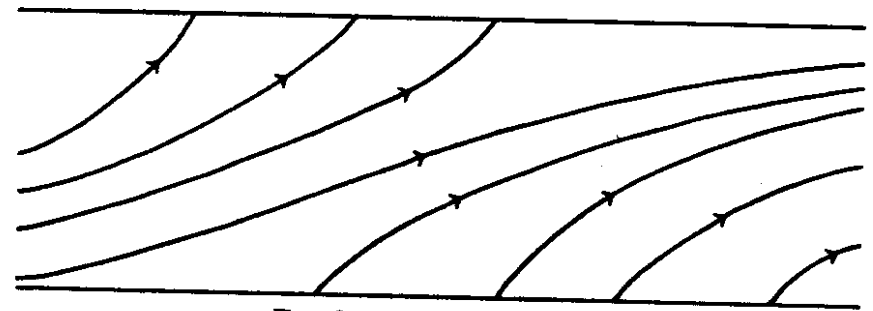

Figure 8-1. A vector field on  $\mathbb{R} \times I$ .

**1.1. Theorem.** Let  $G$  be a time-dependent vector field on  $M$  having bounded velocity. Then  $G$  generates a diffeotopy of  $M$ . That is, there is a unique diffeotopy  $F: M \times I \rightarrow M$  such that

$$\frac{\partial F}{\partial t}(x,t) = G(F(x,t),t).$$

*Proof.* Let  $X: M \times I \rightarrow T(M \times I)$  be the vector field  $X(x,t) = (G(x,t),1)$ . The projection into  $I$  of a solution curve of  $X$  is a curve of the form  $y \mapsto y + t$ . Therefore all solution curves are defined on intervals of length  $\leq 1$ . The condition of bounded velocity implies that  $M$  has a complete Riemannian metric in which all solution curves have finite length. Completeness then implies that each solution curve lies in a compact set. This means solution curves are defined on closed finite intervals, the endpoints of which map into  $M \times 0$  and  $M \times 1$ . It follows that for  $x \in M$  there is a solution curve of  $X$  having the form

$$t \mapsto (F(x,t),t), \quad 0 \leq t \leq 1.$$

This defines the diffeotopy  $F$ . Uniqueness of  $F$  follows from uniqueness of solutions of Lipschitz differential equations.

QED

The *support* of a time-dependent vector field  $G: M \times I \rightarrow TM$  is the set  $\text{Supp } G \subset M$  which is the closure of

$$\{x \in M: G(x,t) \neq 0 \text{ for some } t \in I\}.$$

If  $\text{Supp } G$  is compact then  $G$  has bounded velocity. Therefore an immediate consequence of Theorem 1.1 is:

**1.2. Theorem.** A time-dependent vector field which has compact support generates an isotopy. In particular every time-dependent vector field on a compact manifold generates an isotopy.

The *support*  $\text{Supp } F \subset V$  of an isotopy  $F: V \times I \rightarrow M$  is the closure of  $\{x \in V: F(x,t) \neq F(x,0) \text{ for some } t \in I\}$ :

We can now prove the following *isotopy extension theorems*:

**1.3. Theorem.** Let  $V \subset M$  be a compact submanifold and  $F: V \times I \rightarrow M$  an isotopy of  $V$ . If either  $F(V \times I) \subset \partial M$  or  $F(V \times I) \subset M - \partial M$ , then  $F$  extends to a diffeotopy of  $M$  having compact support.

**1.4. Theorem.** Let  $U \subset M$  be an open set and  $A \subset U$  a compact set. Let  $F: U \times I \rightarrow M$  be an isotopy of  $U$  such that  $\hat{F}(U \times I) \subset M \times I$  is open. Then there is a diffeotopy of  $M$  having compact support, which agrees with  $F$  on a neighborhood of  $A \times I$ .

*Proof of Theorems 1.3 and 1.4.* We first prove Theorem 1.4. The tangent vectors to the curves

$$\hat{F}: x \times I \rightarrow M \times I \quad (x \in U)$$

define a vector field  $X$  on  $\hat{F}(U \times I)$  of the form  $X(y,t) = (H(y,t), 1)$ . Here  $H: \hat{F}(U \times I) \rightarrow TM$  with  $H(y,t) \in M_y$ . By means of a partition of unity we construct a time-dependent vector field  $G: M \times I \rightarrow TM$  which agrees with  $H$  on a neighborhood of  $A \times I$ . (This requires  $\hat{F}(U \times I)$  to be open.) Since  $A \times I$  is compact, we can make  $G$  have compact support. The required diffeotopy of  $M$  is that generated by  $G$ .

To prove Theorem 1.3 we start from the vector field  $X$  on  $\hat{F}(V \times I)$  tangent to the curves  $\hat{F}(x \times I)$ . By means of a tubular neighborhood of  $\hat{F}(V \times I)$  and a partition of unity, the horizontal part of  $X$  is extended to a vector field  $Y$  on a neighborhood of  $\hat{F}(V \times I)$  in  $M \times I$ . The hypothesis on  $F$  allows us to assume that  $Y_{(x,t)}$  is tangent to  $(\partial M) \times I$  whenever  $x \in \partial M$ . After restricting to a smaller neighborhood, the horizontal part of  $Y$  is extended to a compactly supported time-dependent vector field  $G$  on  $M$ . The diffeotopy generated by  $G$  completes the proof of Theorem 1.3.

QED

The following is a frequently used corollary of the isotopy extension theorem.

**1.5. Theorem.** Let  $V \subset N$  be a compact submanifold. Let  $f_0, f_1: V \hookrightarrow M - \partial M$  be embeddings which are isotopic in  $M - \partial M$ . If  $f_0$  extends to an embedding  $N \rightarrow M$  then so does  $f_1$ .

*Proof.* There is an isotopy from the inclusion  $f_0(V) \subset M - \partial M$  to  $f_1 f_0^{-1}: f_0(V) \hookrightarrow M - \partial M$ . Such an isotopy extends to a diffeotopy  $H$  of  $M$  by 1.3. Thus  $H_1: M \rightarrow M$  is a diffeomorphism such that  $H_1|_{f_0(V)} = f_1^{-1} f_0$ , or equivalently  $H_1 f_0 = f_1$ . Therefore if  $g: N \hookrightarrow M$  extends  $f_0$ , then  $H_1 g: N \hookrightarrow M$  is an embedding which extends  $f_1$ .

QED

Compactness in Theorems in 1.3 and 1.4 can be replaced with the weaker hypothesis of bounded velocity of the isotopy. If  $V \subset M$  is a submanifold, an isotopy  $F: V \times I \rightarrow M$  has *bounded velocity* if  $M$  has a complete

Riemannian metric with the property that the tangent vectors to the curves  $t \mapsto F(x,t)$ , have bounded lengths. We obtain:

**1.6. Theorem.** Let  $V \subset M$  be a closed submanifold and  $F: V \times I \rightarrow M$  an isotopy of  $V$  having bounded velocity. If either  $F(V \times I) \subset \partial M$  or  $F(V \times I) \subset M - \partial M$ , then  $F$  extends to a diffeotopy of  $M$  which has bounded velocity.

**1.7. Theorem.** Let  $A \subset M$  be a closed set and  $U \subset M$  an open neighborhood of  $A$ . Let  $F: U \times I \rightarrow M$  be an isotopy of  $U$  having bounded velocity, such that  $\hat{F}(U \times I)$  is open in  $M \times I$ . Then there is a diffeotopy  $G$  of  $M$  having bounded velocity, which agrees with  $F$  on a neighborhood of  $A \times I$ ; and  $\text{Supp } G \subset F(U \times I)$ .

The proofs are left to the reader.

As a corollary of Theorem 1.7 we obtain the *ambient tubular neighborhood theorem*:

**1.8. Theorem.** Let  $A \subset M$  be a closed neat submanifold and let  $U \subset M$  be a neighborhood of  $A$ . Then the  $A$ -germ of any isotopy of tubular neighborhoods of  $A$  extends to a diffeotopy of  $M$  having support in  $U$ .

*Proof.* Since an isotopy of tubular neighborhoods leaves  $A$  pointwise fixed, in some neighborhood of  $A$  it has bounded velocity and we can use Theorem 1.7.

QED

A theorem analogous to Theorem 1.8 holds for collars on  $\partial M$ . It has as a consequence the following *smoothing theorem*, which allows us to change certain kinds of homeomorphisms into diffeomorphisms (see Figure 8-2):

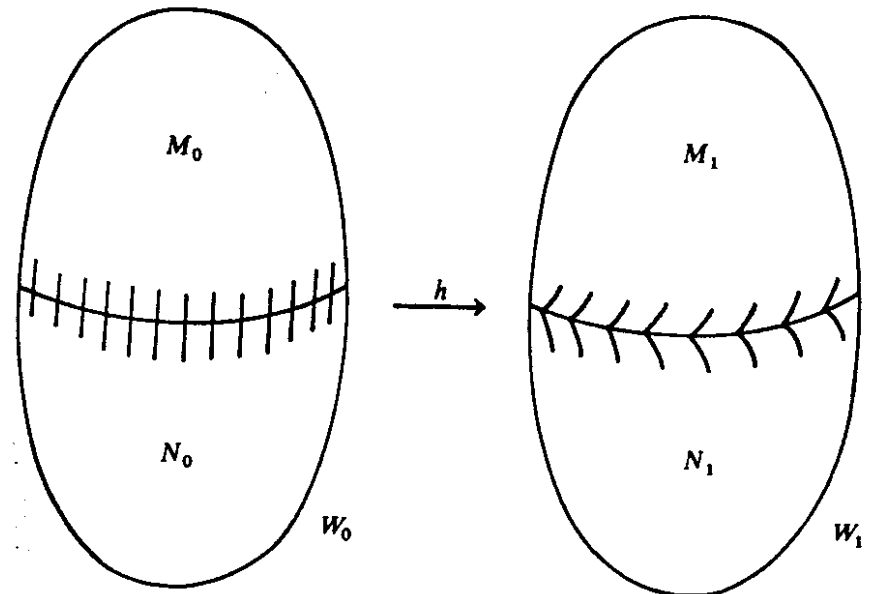

Figure 8-2. Smoothing the homeomorphism  $h$ .

**1.9. Theorem.** For  $i = 0, 1$  let  $W_i$  be an  $n$ -manifold without boundary which is the union of two closed  $n$ -dimensional submanifolds  $M_i, N_i$  such that

$$M_i \cap N_i = \partial M_i = \partial N_i = V_i.$$

Let  $h: W_0 \rightarrow W_1$  be a homeomorphism which maps  $M_0$  and  $N_0$  diffeomorphically onto  $M_1$  and  $N_1$  respectively. Then there is a diffeomorphism  $f: W_0 \approx W_1$  such that  $f(M_0) = M_1$ ,  $f(N_0) = N_1$  and  $f|_{V_0} = h|_{V_0}$ . Moreover  $f$  can be chosen so as to coincide with  $h$  outside a given neighborhood  $Q$  of  $V_0$ .

*Proof.* Choose a tubular neighborhood  $\tau_i$  for  $V_i$  in  $W_i$ . This defines a collar  $\tau_i|_{M_i}$  on  $V_i$  in  $M_i$ , and  $\tau_i|_{N_i}$  on  $V_i$  in  $N_i$ . We have another collar  $h(\tau_0|_{M_0})$  on  $V_1$  in  $M_1$ , which is the collar induced from  $\tau_0|_{M_0}$  by  $h|_{M_0}$ . By the ambient tubular neighborhood Theorem 1.8 we can isotop  $h|_{M_0}: M_0 \rightarrow M_1$  to a new diffeomorphism  $f': M_0 \rightarrow M_1$ ,  $f' = h$  on  $V_0$  and on  $M_0 - Q$ , such that  $f'(\tau_0|_{M_0})$  has the same  $V_1$ -germ as  $\tau_1|_{M_1}$ . Similarly we can isotop  $h|_{N_0}: N_0 \rightarrow N_1$  to  $f'': N_0 \rightarrow N_1$  so that  $f'' = h$  on  $V_0$  and on  $N_0 - Q$ , and the collar  $f''(\tau_0|_{N_0})$  has the same  $V_1$ -germ as  $\tau_1|_{N_1}$ . The map  $f' \cup f'': W_0 \rightarrow W_1$  is then the required diffeomorphism  $f$ .

QED

By choosing collars more carefully, we can even make  $f = h$  on  $M_0$  (or on  $M_1$ ).

### Exercises

- The relation “ $f$  is isotopic to  $g$ ” is an equivalence relation on  $\text{Emb}^{\infty}(M, N)$ .
- If  $f_0, f_1: M \hookrightarrow N$  are isotopic and  $g_0, g_1: N \hookrightarrow W$  are isotopic, then  $g_0 f_0, g_1 f_1: M \hookrightarrow W$  are isotopic.
- (a) If  $F: M \times I \rightarrow N$  is an isotopy, the map  $I \rightarrow \text{Emb}_{\text{reg}}^{\infty}(M, N)$ ,  $t \mapsto F_t$ , is continuous.  
(b) Conversely, every continuous map  $\lambda: I \rightarrow \text{Emb}_{\text{reg}}^{\infty}(M, N)$  can be approximated by maps  $\mu$  such that  $\mu(i) = \lambda(i)$ ,  $i = 0, 1$ , and the map  $M \times I \rightarrow N$ ,  $(x, t) \mapsto \mu(t)(x)$  is an isotopy.  
(c) Part (b), but not (a), is true for  $\text{Emb}_c^{\infty}(M, N)$ .
- The theorems of Section 8.1 are true for  $C^r$  isotopies (supply the definition) and  $C^r$  vector fields,  $1 \leq r < \infty$ . But some of them are false for  $C^{\infty}$  isotopies.
- The equivalence classes of the relation “ $f$  is isotopic to  $g$ ,” on  $\text{Emb}^{\infty}(M, V)$ , are open sets in the strong topology.
- Let  $V \subset M$  be a submanifold. A  $k$ -isotopy of  $V$  ( $k = 2, 3, \dots$ ) is a  $(C^{\infty})$  map  $F: V \times I^k \rightarrow M$  such that for each  $t \in I^k$  the map  $F|_{V \times t}$  is an embedding. Similarly one defines  $k$ -diffeotopy of  $M$ . If  $V \subset M - \partial M$  and  $V$  is compact, then every  $k$ -isotopy of  $V$  extends to a  $k$ -diffeotopy of  $M$  with “compact support.”
- (a) Let  $M$  be a compact  $n$ -manifold without boundary and  $f: M \hookrightarrow \mathbb{R}^{n+1}$  an embedding. If  $L \in GL(n+1)$  has negative determinant then  $f$  is not isotopic to  $L \circ f$ . [Hint: Consider the degree of the Gauss map  $\gamma: M \rightarrow S^n$  where  $\gamma(x)$  is the outward unit normal vector at  $x \in M$ .]

(b) The inclusion of  $S^n \hookrightarrow \mathbb{R}^{n+1}$  is isotopic to the antipodal embedding  $(x \mapsto -x)$  if and only if  $n$  is odd.

8. Suppose  $\partial M^n$  is compact. If  $M^n$  embeds in  $\mathbb{R}^q$ ,  $q \geq 2n$  then every embedding  $\partial M^n \rightarrow \mathbb{R}^q$  extends to  $M^n$ .

\*9. Let  $L \subset \mathbb{R}^3$  be obtained from a straight line by putting a small knot in it thus:



(a) There is an isotopy  $F_t$  of  $L$  in  $\mathbb{R}^3$  such that  $F_1(L)$  is a straight line  $R$ . [“Roll” the knot to infinity.]

(b) Such an isotopy cannot be ambient because  $\mathbb{R}^3 - L$  and  $\mathbb{R}^3 - R$  have different fundamental groups.

10. Let  $f, g: M \hookrightarrow V$  be homotopic embeddings. If  $1 + \dim V > 2(1 + \dim M)$ , then  $f$  and  $g$  are isotopic. [Let  $F: M \times I \rightarrow V$  be a homotopy from  $f$  to  $g$ . Approximate the map  $M \times I \rightarrow V \times I$ ,  $(x, t) \mapsto (F(x, t), t)$  by an embedding  $H$ . Write  $H(x, t) = (G(x, t), K(x, t)) \in V \times I$ . Then, assuming  $H(x, t) = F(x, t)$  for  $i = 0, 1$ , the map  $G: M \times I \rightarrow V$  is an isotopy from  $f$  to  $g$ .]

\*11. Let  $M, V$  be noncompact manifolds,  $\partial M = \partial V = \emptyset$ . Let  $f, g: M \hookrightarrow V$  be embeddings that are homotopic by a proper map  $M \times I \rightarrow V$ . If  $1 + \dim V > 2(1 + \dim M)$  then there is a proper ambient isotopy from  $f$  to  $g$ .

\*12. Can the dimension restriction in Exercise 11 be weakened?

13. Let  $M$  be a compact submanifold of  $Q$ . Suppose  $\partial Q = \emptyset$  and  $\dim Q \geq 2 \dim M + 2$ . If  $M$  is contractible to a point in  $Q$  then:

- $M$  can be isotoped into any open subset of  $Q$ ; and
- $M$  lies in a coordinate domain.

14. Let  $M, N \subset S^d$  be disjoint compact submanifolds. Suppose  $\dim M + \dim N < d - 1$ . Then  $M$  and  $N$  can be geometrically separated by an isotopy. This means that there is a diffeotopy of  $S^d$  carrying  $M$  into the northern hemisphere  $E_+^d$  and  $N$  into the southern hemisphere  $E_-^d$ . [Assume  $d \geq 2 \dim M + 2$ . Use Exercise 13 to isotop  $M$  into  $E_+^d$ . By general position choose the isotopy to avoid  $N$ . Extend to an ambient isotopy of  $S^d - N$  having compact support; etc.]

\*15. This exercise outlines a geometric proof of the “easy part” of the celebrated Freudenthal suspension theorem of homotopy theory: the suspension homomorphism  $\Sigma: \pi_m(S^q) \rightarrow \pi_{m+1}(S^{q+1})$  is surjective if  $m < 2q$  and injective if  $m < 2q - 1$ . Here  $\pi_m(S^q)$  is the set of homotopy classes of maps  $S^m \rightarrow S^q$  (the group structure is irrelevant).  $\Sigma$  is defined as follows.

Given  $f: S^m \rightarrow S^q$ , let  $\Sigma f: S^{m+1} \rightarrow S^{q+1}$  coincide with  $f$  on the equator and map the north and south poles  $S^{m+1}$  to the corresponding poles of  $S^{q+1}$ ; and let  $\Sigma f$  map each great circle quadrant of  $S^{m+1}$ , joining a pole to the equator, isometrically onto a great circle quadrant of  $S^{q+1}$ .

(a) A map  $g: S^{m+1} \rightarrow S^{q+1}$  is homotopic to a suspension if

$$g(E_+^{m+1}) \subset E_+^{q+1} \quad \text{and} \quad g(E_-^{m+1}) \subset E_-^{q+1}.$$

(b) A map  $g: S^{m+1} \rightarrow S^{q+1}$  is homotopic to a suspension if  $g^{-1}$  (north pole)  $\subset \text{Int } E_+^{m+1}$  and  $g^{-1}$  (south pole)  $\subset \text{Int } E_-^{m+1}$ . (For then  $g(E_+^{m+1}) \subset S^{q+1} - \text{(south pole)}$  which deforms into  $E_+^{q+1}$ ; etc.)

- (c) If  $m < 2q$  then  $\sum: \pi_m(S^q) \rightarrow \pi_{m+1}(S^{q+1})$  is surjective. [Assume the poles of  $S^{q+1}$  are regular values; use (b) and Exercise 14.]
- (d) If  $m < 2q - 1$  then  $\sum: \pi_m(S^q) \rightarrow \pi_{m+1}(S^{q+1})$  is injective. [Imitate the proof of (c) to show that a homotopy from  $\sum(f)$  to  $\sum(g)$  is homotopic to the suspension of a homotopy from  $f$  to  $g$ .]

- 16. The conclusion of Theorem 1.5 is true for isotopic embeddings  $V \hookrightarrow M$ .
- \*17. Figure 1-5 (p. 28) shows three surfaces in  $\mathbb{R}^3$ . There are diffeotopies of  $\mathbb{R}^3$  carrying any one of them onto any other!

## 2. Gluing Manifolds Together

Suppose that  $P$  and  $Q$  are  $n$ -dimension  $\partial$ -manifolds and that  $f: \partial Q \approx \partial P$  is a diffeomorphism. The adjunction space  $W = P \cup_f Q$  is a topological manifold containing natural copies of  $P$  and  $Q$ . We can give  $W$  a differential structure which extends the differential structures on  $P$  and  $Q$ . The object of this section is to show that all such differential structures on  $W$  are diffeomorphic.

For notational simplicity we identify  $P$  and  $Q$  with their images in  $W$ . Let  $\partial P = \partial Q = V$ . By means of collars on  $V$  in  $P$  and  $Q$ , we find a homeomorphism of a neighborhood  $U \subset W$  of  $V$  onto  $V \times \mathbb{R}$  taking  $x \in V$  to  $(x, 0)$ , and which maps  $U \cap P$  and  $U \cap Q$  diffeomorphically onto  $V \times [0, \infty)$  and  $V \times (-\infty, 0]$ , respectively. We give  $U$  the differential structure induced by this homeomorphism. The required differential structure on  $W$  is obtained by collation from  $P$ ,  $Q$ , and  $U$ .

In defining this differential structure on  $W$ , various choices were made. The following result, called *uniqueness of gluing*, says that the diffeomorphism type of  $W$  is independent of these choices. It merely restates Theorem 1.9.

**2.1. Theorem.** *Let  $f: \partial Q \approx \partial P$  be a diffeomorphism. Let  $\alpha, \beta$  be two differential structures on  $W = P \cup_f Q$  which both induce the original structure on  $P$  and  $Q$ . Then there is a diffeomorphism  $h: W_\alpha \approx W_\beta$  such that  $h|_P = 1_P$ .*

This theorem is somewhat unsatisfying in that there is no *canonical* differential structure on  $P \cup_f Q$ ; there is only a *canonical diffeomorphism class* of structures. Differential topologists generally ignore this, and treat  $P \cup_f Q$  as a well-defined differentiable manifold. Since it leads to no trouble and saves a good deal of writing, we shall follow this practice.

The following is a useful criterion for diffeomorphism of two glued manifolds:

**2.2. Theorem.** *Let  $f_0: \partial Q_0 \approx \partial P$  and  $f_1: \partial Q_1 \approx \partial P$  be diffeomorphisms. Suppose that the diffeomorphism  $f_1^{-1}f_0: \partial Q_0 \approx \partial Q_1$  extends to a diffeomorphism  $h: Q_0 \approx Q_1$ . Then  $P \cup_{f_0} Q_0 \approx P \cup_{f_1} Q_1$ .*

*Proof.* A map

$$\psi: P \cup_{f_0} Q_0 \rightarrow P \cup_{f_1} Q_1$$

is well-defined by  $\psi|_P = 1_P$ ,  $\psi|_{Q_0} = h$ . Now apply Theorem 1.9 and the remark following it.

QED

An important special case is:

**2.3. Theorem.** *Let  $f, g: \partial Q \approx \partial P$  be isotopic diffeomorphisms. Then  $P \cup_f Q \approx P \cup_g Q$ .*

*Proof.*  $g^{-1}f$  is isotopic to the identity of  $\partial Q$ . The isotopy can be spread out over a collar on  $\partial Q$  and then extended to a diffeomorphism of  $Q$  which is the identity outside the collar. Now use Theorem 2.2.

QED

## 3. Isotopies of Disks

The following useful result says that, except perhaps for orientation, there is essentially only one way to embed a disk in a connected manifold.

**3.1. Theorem.** *Let  $M$  be a connected  $n$ -manifold and  $f, g: D^k \hookrightarrow M$  embeddings of the  $k$ -disk,  $0 \leq k \leq n$ . If  $k = n$  and  $M$  is orientable, assume that  $f$  and  $g$  both preserve, or both reverse, orientation. Then  $f$  and  $g$  are isotopic. If  $f(D^k) \cup g(D^k) \subset M - \partial M$ , an isotopy between them can be realized by a diffeotopy of  $M$  having compact support.*

*Proof.* We shall use repeatedly the fact that isotopy is an equivalence relation on the set of embeddings.

First assume  $\partial M = \emptyset$ .

Since  $M$  is connected, the embeddings  $f|_0, g|_0: 0 \rightarrow M$  are isotopic; by Theorem 1.3 they are ambiently isotopic. Therefore we may assume  $f(0) = g(0)$ .

Let  $(\varphi, U)$  be a chart on  $M$  at  $f(0)$  such that  $\varphi(U, f(0)) = (\mathbb{R}^n, 0)$ . We can radially isotop  $f$  and  $g$  to embeddings in  $U$ ; consider, for example, the isotopy

$$(x, t) \mapsto f((1 - t + t\varepsilon)x), \quad x \in D^k, \quad 0 \leq t \leq 1,$$

for sufficiently small  $\varepsilon > 0$ . Therefore we assume

$$f(D^k) \cup g(D^k) \subset U.$$

If  $k = n$  we can further assume that  $f$  and  $g$  both preserve or both reverse orientations, as embeddings into the orientable manifold  $U$ . If  $M$  is orientable this follows from the hypothesis. If  $M$  is not orientable we can replace  $f$ , if necessary, by an isotopic embedding obtained by isotoping  $f$  around an orientation reversing loop based at  $f(0)$ .

It suffices to show that  $\varphi f, \varphi g: D^k \rightarrow \mathbb{R}^n$  are isotopic. If  $k = n$  we can assume, by proper choice of  $\varphi$ , that both embeddings preserve orientation.

Moreover we can also assume, for any  $k$ , that  $\varphi f$  and  $\varphi g$  are linear: any embedding  $h: D^k \rightarrow \mathbb{R}^n$  with  $h(0) = 0$  is isotopic to a linear one by the standard isotopy (see proof of Theorem 4.5.3):

$$(x,t) \rightarrow \begin{cases} t^{-1}h(tx), & 1 \geq t > 0 \\ Dh(0)x, & t = 0. \end{cases}$$

If  $\varphi f$  and  $\varphi g$  are linear, and  $k = n$ , then their determinants are both positive, by our orientation assumptions. Hence they are restriction of maps in the same component of  $GL(n)$ . A smooth path in  $GL(n)$  provides the required isotopy. If  $k < n$ , we can first extend  $f$  and  $g$  to linear automorphisms of  $\mathbb{R}^n$  having positive determinants and then use a path in  $GL(n)$ . This finishes the proof when  $\partial M = \emptyset$ .

If  $\partial M \neq \emptyset$ , first isotop  $f$  and  $g$  into  $M - \partial M$  by isotoping  $M$  into  $M - \partial M$ ; this is easily accomplished with a collar on  $\partial M$ . Then apply the previous constructions to  $f, g: D^k \rightarrow M - \partial M$ .

QED

An argument similar to the proof of Theorem 3.1 applies to embeddings of a disjoint union of disks. The following result about pairs of disks generalizes readily to any number of disks.

**3.2. Theorem.** *Let  $M$  be a connected  $n$ -manifold without boundary. Suppose that  $f_i, g_i: D^n \rightarrow M$  ( $i = 1, 2$ ) are embeddings such that*

$$f_1(D^n) \cap f_2(D^n) = \emptyset = g_1(D^n) \cap g_2(D^n).$$

*If  $M$  is orientable suppose further that  $f_i$  and  $g_i$  both preserve, or both reverse, orientation. Then there is a diffeomorphism  $H: M \rightarrow M$  which is diffeotopic to the identity such that  $Hf_i = g_i$  ( $i = 1, 2$ ).*

*Proof.* By Theorem 3.1,  $f_1$  and  $g_1$  are ambiently isotopic. Hence there is a diffeomorphism  $H_1$  of  $M$ , diffeotopic to the identity, with  $H_1 f_1 = g_1$ . We now apply Theorem 3.1 the embeddings

$$H_1 f_2, g_2: D^n \hookrightarrow M^n - g_1(D^n).$$

There is diffeomorphism  $H_2$  of  $M^n - g_1(D^n)$  such that  $H_2 H_1 f_2 = g_2$ , and  $H_2$  is isotopic to the identity by a diffeotopy with compact support. Such a diffeotopy extends to all of  $M$  so as to leave  $g_1(D^n)$  fixed. Therefore  $H_2$  extends to a diffeomorphism of  $M$  which is diffeotopic to  $1_M$  and such that  $H_2 g_1 = g_1$ . The theorem is proved by setting  $H = H_2 H_1$ .

QED

Finally we consider diffeotopies of the circle.

**3.3. Theorem.** *Every diffeomorphism of  $S^1$  is isotopic to the identity or to complex conjugation. Therefore every diffeomorphism of  $S^1$  extends to a diffeomorphism of  $D^2$ .*

*Proof.* Let  $f: S^1 \rightarrow S^1$  be a diffeomorphism. First suppose  $f$  has degree 1. By a preliminary isotopy we may assume  $f$  is the identity on some open interval  $J \subset S^1$ . Let  $J' \subset S^1$  be an open interval such that  $J \cup J' = S^1$ . Identify  $J'$  with an interval of real numbers. An isotopy from  $f$  to the identity is given by

$$f_t(x) = \begin{cases} x & \text{if } x \in J \\ tx + (1-t)f(x) & \text{if } x \in J'. \end{cases}$$

Now suppose  $\deg f = -1$ . Let  $\delta: S^1 \rightarrow S^1$  be complex conjugation. Then  $\deg(f\delta) = 1$  so  $f\delta$  is isotopic to the identity by an isotopy  $g_t$ . Then  $g_t\delta$  is an isotopy from  $f$  to  $\delta$ .

QED

**3.4. Corollary.** *Let  $M$  be a compact 2-manifold without boundary admitting a Morse function having only 2 critical points. Then  $M \approx S^2$ .*

*Proof.* By Theorem 5.6.4 (and its proof)  $M$  is the union of two 2-disks glued along their boundaries. We may take the disks to be the upper and lower hemispheres of  $S^2$ ; by Theorem 3.3 we may take the gluing map to be the identity. The result now follows from Theorem 2.3.

### Exercises

- An embedding  $f: S^{k-1} \hookrightarrow M$  is *unknotted* if  $f$  extends to an embedding of  $D^k$ .
  - $f$  is unknotted if and only if there is a chart  $\varphi: U \rightarrow \mathbb{R}^n$  on  $M$  and an isotopy  $F$  of  $f$  such that  $\varphi F_1: S^{k-1} \hookrightarrow \mathbb{R}^n$  is the standard inclusion.
  - An embedding  $f: S^1 \hookrightarrow \mathbb{R}^3$  is unknotted if and only if there is a compactly supported isotopy of  $\mathbb{R}^3$  carrying  $f$  to the standard inclusion.
  - Let  $M$  be a simply connected 4-manifold. Then every embedding  $S^1 \hookrightarrow M$  is unknotted.
- The orthogonal group  $O(n)$  is a deformation retract of  $\text{Diff}_*(\mathbb{R}^n)$ ,  $1 \leq n < \infty$ .
- If  $M$  is an orientable manifold denote by  $\text{Diff}_+(M)$  the group of orientation preserving diffeomorphisms. Let  $G \subset \text{Diff}_+(S^n)$  be the image of  $\text{Diff}_+(D^{n+1})$  under the restriction homomorphism.
  - If  $f \in \text{Diff}_+(S^n)$  is isotopic to the identity, then  $f \in G$ .
  - Let  $g, h \in \text{Diff}_+(S^n)$ . Then  $g$  and  $h$  are isotopic to diffeomorphisms  $u, r$  which are the identity on the upper and lower hemispheres, respectively; this implies  $ur = ru$ .
  - The quotient group  $\Gamma_{n+1} = \text{Diff}_+(S^n)/G$  is abelian.
  - $\Gamma_2 = \{0\}$ .
  - $\Gamma_3 = \{0\}$ . (Smale [2]; Munkres [2].) [Hint: Let  $f \in \text{Diff}_+(S^2)$ . By an isotopy assume  $f$  is the identity on a hemisphere. It now suffices to show that a diffeomorphism  $g$  of  $\mathbb{R}^2$ , having compact support  $K \subset \mathbb{R}^2$ , is isotopic to the identity through such diffeomorphisms. The unit tangents to images of horizontal lines form a vector field  $X$  on  $\mathbb{R}^2$  which is constant outside  $K$ , and  $X$  is homotopic to a constant rel  $\mathbb{R}^2 - K$ . By the Poincaré–Bendixson theorem, such a homotopy gives rise to an isotopy of  $g$ .]

**Remark.** These groups  $\Gamma_i$  are important in classifying differential structures. The set of diffeomorphism classes of oriented differential structures on  $S^i$  forms a group under connected sum. This group is isomorphic to  $\Gamma_i$  except perhaps for  $i = 4$ . It is known that the  $\Gamma_i$  are finite for all  $i$ . The first nontrivial group is  $\Gamma_7 \approx \mathbb{Z}_{28}$ . For an interesting (and difficult!) Morse-theoretic proof that  $\Gamma_4 = \{0\}$  see J. Cerf [1].



## Chapter 9

### Surfaces

Un des problèmes centraux posés à l'esprit humain est le problème de la succession des formes.

—R. Thom, *Stabilité Structurelle et Morphogénèse*, 1972

Concerned with forms we gain a healthy disrespect for their authority . . .

—M. Shub, For Ralph, 1969

A *surface* is a two-dimensional manifold. The classification of compact surfaces was “known,” in some sense, by the end of the nineteenth century. Möbius [1] and Jordan [1] offered proofs (for orientable surfaces in  $\mathbb{R}^3$ ) in the 1860's. Möbius' paper is quite interesting; in fact he used a Morse-theoretic approach similar to the one presented in this chapter. The main interest in Jordan's attempt is in showing how the work of an outstanding mathematician can appear nonsensical a century later.

Of course in those days very few topological concepts had been developed. Both Jordan and Möbius considered two surfaces equivalent if they could be “decomposed into infinitely small pieces in such a way that contiguous pieces of one correspond to contiguous pieces of the other.” The difficulties of trying to prove anything on the basis of such a definition are obvious.

The main idea in classifying surfaces goes back to Riemann: cut the surface along closed curves, and arcs joining boundary points, until any further cuts will disconnect it. The maximal number of cuts which can be made without disconnecting the surface, plus 1, was called the *connectivity* by Riemann. Thus a sphere or disk has connectivity 1, or is *simply connected*; an annulus has connectivity 2; a torus has connectivity 3; and so on. What Möbius and Jordan tried to prove is that two compact connected oriented surfaces are homeomorphic if and only if they have the same connectivity and same number of boundary circles.

Riemann proved, more or less, the subtle fact that every maximal set of non-disconnecting cuts has the same cardinality. It seems strange that neither Riemann nor anyone else in the nineteenth century, except perhaps Möbius, seems to have realized the necessity for proving that the connectivity of a compact surface is in fact *finite*.

If one grants the finiteness of the connectivity, the classification reduces to that of simply connected surfaces. The latter is another deep result, for which the nineteenth century offers little in the way of proof.

The connectivity is an intuitively appealing concept, but perhaps for this very reason, it is hard to work with. It is best treated by means of homology theory (see Exercise 17 of Section 9.3).

It turns out that every compact connected surface  $M$  is diffeomorphic to one obtained as follows. Punch out a number  $v$  of 2-disks from  $S^2$ ; glue in  $g$  cylinders (if  $M$  is orientable) or  $g$  Möbius bands (if  $M$  is nonorientable). The number  $g$ , called the *genus* of  $M$ , is uniquely determined by  $M$ . The diffeomorphism class of  $M$  is characterized by its genus, orientability, and number of boundary components.

The proof of this classification is structured as follows. In Section 9.1 model surfaces are constructed and analyzed. The hardest step is in Section 9.2: the proof that a surface is a disk if it has an admissible Morse function with 2 minima, 1 saddle and no other critical points. The proof given extends to higher dimensions. The classification is completed in Section 9.3 by induction on the number of saddles of a Morse function on the surface.

### 1. Models of Surfaces

Here is a way of constructing a surface. Start with a surface  $M$  and an embedding

$$f: S^0 \times D^2 \hookrightarrow M - \partial M.$$

The image of  $f$  is a pair of disjoint disks in  $M$ . Now cut out the interior of these disks and glue in the cylinder  $D^1 \times S^1$  by  $f|_{S^0 \times S^1}$ . This produces a new surface  $M'$ :

$$M' = [M - \text{Int } f(S^0 \times D^2)] \cup_f D^1 \times S^1.$$

We give  $M'$  a differential structure inducing the original structure on  $M - \text{Int } f(S^0 \times D^2)$  and  $D^1 \times S^1$ . By Theorem 8.2.1, this structure is unique up to diffeomorphism. We shall pretend that  $M'$  is a well-defined differentiable manifold and write  $M' = M[f]$ . We say  $M'$  is obtained from  $M$  by *attaching a handle*, or by *surgery on  $f$* .

**1.1. Theorem.** *Let  $M$  be a surface and let  $f_0, f_1: S^0 \times D^2 \rightarrow M - \partial M$  be isotopic embeddings. Then  $M[f_0] \approx M[f_1]$ .*

*Proof.* By the isotopy extension Theorem 8.1.3 there is a diffeomorphism  $\varphi: M \rightarrow M$  such that  $\varphi f_0 = f_1$ . Put  $M - \text{Int } f_i(S^0 \times D^2) = Q_i$ ,  $i = 0, 1$ . Put

$$g_i = f_i^{-1}|_{\partial Q_i}: \partial Q_i \approx S^0 \times S^1.$$

Then

$$\begin{aligned} M[f_0] &= (D^1 \times S^1) \cup_{g_0} Q_0 \\ M[f_1] &= (D^1 \times S^1) \cup_{g_1} Q_1. \end{aligned}$$

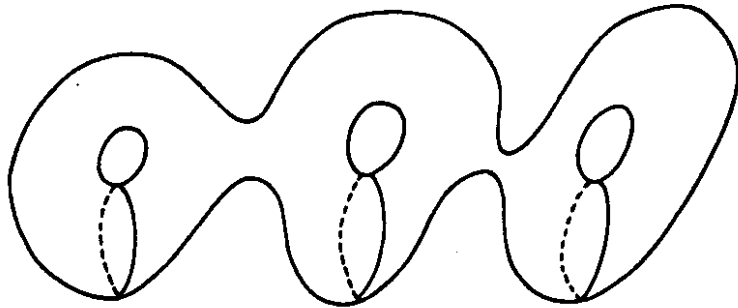

Figure 9-1. Connected sum of 3 tori.

nonorientable surface. Note that  $\partial B \approx S^1$ . Any surface diffeomorphic to  $B$  is also called a Möbius band.

If  $M$  is any surface without boundary then

$$M \# P \approx (M - \text{Int } D) \cup_f B$$

where  $D \subset M$  is a disk and  $f: \partial B \approx \partial M$  is arbitrary. This is because the projective plane is obtained by gluing  $D^2$  and  $B$  along their boundaries.

The image of  $B$  in  $M \# P$  is also called a *crosscap*, especially when we think of it as obtained as above by gluing. A nonorientable surface of genus  $p \geq 1$  is also called a sphere with  $p$  crosscaps attached.

An easy computation shows that the Euler characteristic of a nonorientable surface of genus  $p$  is  $2 - p$ .

**1.6. Theorem.** *Let  $M, N$  be nonorientable surfaces of genus  $p, q$  respectively. Then  $M \approx N$  if and only if  $p = q$ .*

*Proof.* Left as an exercise.

A nonorientable surface of genus 2 is called a *Klein bottle*. It can be obtained from a sphere by attaching a handle by any nonorientable embedding  $S^0 \times D^2 \rightarrow S^2$ .

Let  $M$  be a connected nonorientable surface without boundary. Let  $f: S^0 \times D^1 \hookrightarrow M$  and consider  $M[f]$ . We may suppose the image of  $f$  is contained in the interior of a small disk  $D \subset M$ . Thus  $M[f]$  is obtained by gluing together  $M - \text{Int } D$  and  $D[f]$  along their boundaries. If we identify  $D$  with a hemisphere of  $S^2$ , and reinterpret  $f$  as an embedding  $g: S^0 \times D^2 \rightarrow S^2$ , we find that  $M[f] \approx M \# S^2[g]$ . Now  $S^2[g]$  is a torus if  $g$  is orientable, and Klein bottle otherwise; and the orientability of  $g$  is the same as that of  $f: S^0 \times D^2 \hookrightarrow D$ . But since  $M$  is nonorientable, we can isotop  $f(1 \times D^2)$  around an orientation reversing loop. This leads to another embedding  $f_1: S^0 \times D^2 \rightarrow D$  which is isotopic to  $f$  in  $M$ , and which is orientable if and only if  $f$  is nonorientable. Thus

$$M[f] \approx M \# S^2[f] \approx M \# S^2[f_1]$$

where  $S^2[f]$  is a torus and  $S^2[f_1]$  is a Klein bottle. Since a Klein bottle is a sphere with two crosscaps, this proves:

**1.7. Theorem.** *Attaching a handle to a connected nonorientable surface is the same as attaching two crosscaps. Therefore attaching a handle to a nonorientable surface of genus  $p$  produces a nonorientable surface of genus  $p + 2$ .*

A dual result is:

**1.8. Theorem.** *Let  $M$  be an orientable surface of genus  $p$ . Attaching a crosscap to  $M$  yields a nonorientable surface of genus  $2p + 1$ .*

*Proof.* This is clear if  $p = 0$ . If  $p > 0$  consider  $M$  as the connected sum of  $p$  tori. Then  $M \# P$  is the same as  $P$  with  $p$  handles, and the preceding result applies.

QED

We now construct models of  $\partial$ -surfaces by simply cutting out the interiors of a number  $k > 0$  of disjoint disks from an orientable or nonorientable surface  $M$  of genus  $g$ . The result is called a  $\partial$ -surface of genus  $g$  with  $k$  boundary components. By isotopy of disks (Section 8.3), the diffeomorphism class of such a surface depends only on  $M$  and the number of disks.

By a *model surface* we mean a surface or  $\partial$ -surface of genus  $g$ , orientable or nonorientable. In Section 9.3 we shall show that every compact connected surface is diffeomorphic to a unique type of model surface.

It is clear that two model surfaces are diffeomorphic if and only if (a) they have the same genus and the same number of boundary circles, and (b) both are orientable or both are nonorientable.

If a model surface  $M$  has genus  $g$ , and  $\partial M$  has  $b$  components, then its Euler characteristic  $\chi$  is  $2 - 2g - b$  if  $M$  is orientable, while  $\chi = 2 - g - b$  if  $M$  is not orientable. (See Exercise 7, Section 5.2) This proves:

**1.9. Theorem.** *Two model surfaces are diffeomorphic if and only if they have the same genus, the same Euler characteristic, and the same number of boundary components.*

### Exercises

1. An orientable surface of genus  $p$  contains  $p$  disjoint circles whose union does not separate the surface.
2. A nonorientable surface of genus  $p$  contains  $p$  disjoint circles each of which reverses orientation.
3. Let  $C \subset M$  be a circle in a surface  $M$  without boundary, which does not disconnect  $M$ .
  - (a) If  $C$  reverses orientation, it has a Möbius band neighborhood and there is a surface  $N$  such that  $M \approx N \# P^2$ .
  - (b) There is a circle  $C' \subset M$  meeting  $C$  transversely, and at only one point. Moreover:
  - (c)  $C \cup C'$  has a neighborhood  $N \subset M$  diffeomorphic to  $T - \text{Int } D$  where  $D$  is a disk in the torus  $T$ . Consequently  $M \approx W \# T^2$  for some surface  $W$ .

The diffeomorphism  $g_1^{-1}g_0:\partial Q_0 \rightarrow \partial Q_1$  extends to the diffeomorphism  $\varphi:Q_0 \approx Q_1$ . The theorem follows by Theorem 8.2.2.

QED

**1.2. Corollary.** *Let  $M$  be a connected surface. If  $M$  is nonorientable, all surfaces obtained by attaching a handle to  $M$  are diffeomorphic.*

*Proof.* Use Theorem 8.3.2.

QED

We give  $S^0 \times D^2$  its product orientation. This means that  $1 \times D^2$  is oriented like the standard orientation of  $D^2$ , while  $(-1) \times D^2$  is given the opposite orientation. This orientation of  $S^0 \times D^2$  induces an orientation of  $S^0 \times S^1$  which is the same as it receives as  $\partial(D^1 \times S^1)$ , where  $D^1$  and  $S^1$  are given their standard orientations.

Let  $M$  be a surface, and let  $f:S^0 \times D^2 \rightarrow M$  be an embedding. If  $M$  can be oriented so that  $f$  preserves orientation, we call  $f$  an *orientable embedding*. In all other cases  $f$  is *nonorientable*. It is easy to prove:

**1.3. Theorem.**  *$M[f]$  is orientable if and only if  $f$  is orientable.*

A connected manifold is called *reversible* if it is orientable and admits an orientation reversing diffeomorphism.

**1.4. Theorem.** *Let  $M$  be a connected surface and  $f, g:S^0 \times D^2 \rightarrow M - \partial M$  embeddings. Then  $M[f] \approx M[g]$  in the following cases:*

- (a)  $M$  is nonorientable;
- (b)  $M$  is oriented and  $f$  and  $g$  both preserve or both reverse orientation;
- (c)  $M$  is reversible and both  $f$  and  $g$  are orientable.

*Proof.* Part (a) has already been proved (Corollary 1.2). Part (b) follows from Theorem 8.3.2. To prove (c) it suffices to consider the case where  $M$  is oriented so that  $f$  preserves and  $g$  reverses orientation [since other cases are covered by (b)]. Let  $h:M \rightarrow M$  reverse orientation. Then  $M[hg] \approx M[f]$  by (b). We must prove  $M[hg] \approx M[g]$ . Let  $\rho:S^0 \times D^2 \rightarrow S^0 \times D^2$  be the orientation reversing diffeomorphism  $\rho(x,y) = (-x,y)$ . Then  $M[hg] \approx M[g\rho]$ . But since  $\rho|_{S^0 \times S^1}$  extends to a diffeomorphism of  $D^1 \times S^1$ , it follows from Theorem 8.2.2 that  $M[g\rho] \approx M[g]$ .

QED

**1.5. Lemma.** *Let  $M$  be a reversible surface and  $f:S^0 \times D^2 \rightarrow M - \partial M$  an orientable embedding. Then  $M[f]$  is reversible.*

*Proof.* Let  $h:M \rightarrow M$  be an orientation reversing diffeomorphism. Let  $\rho:S^0 \times D^2 \rightarrow S^0 \times D^2$  be an orientation reversing diffeomorphism such that  $\rho|_{S^0 \times S^1}$  extends to a diffeomorphism  $\bar{\rho}$  of  $D^1 \times S^1$ .

By ambient isotopy of disks, there is a diffeotopy of  $M$  carrying  $h$  to a diffeomorphism  $g:M \rightarrow M$  such that  $gf = f\rho$ . Note that  $g$  reverses orientation.

Consider the map  $\varphi:M[f] \rightarrow M[g]$  which is  $\bar{\rho}$  on  $D^1 \times S^1$  and  $g$  on  $M - \text{Int } f(S^0 \times D^2)$ . Clearly  $\varphi$  is an orientation reversing homeomorphism. By uniqueness of gluing (Theorem 8.2.1)  $\varphi$  can be made into a diffeomorphism.

QED

We now define an important class of surfaces. Let  $p \geq 0$  be an integer. An orientable surface  $M$  is of *genus  $p$*  provided  $M$  can be obtained from  $S^2$  by successively attaching handles  $p$  times. That is, there must exist a sequence of orientable surfaces  $M_0, \dots, M_p$  and orientable embeddings  $f_i:S^0 \times D^2 \rightarrow M_{i-1}$ ,  $i = 1, \dots, p$  (if  $p > 0$ ) such that

$$M_0 \approx S^2, \quad M_i \approx M_{i-1}[f_i], \quad M_p = M.$$

Thus each  $M_i$  has genus  $i$ . Later we shall also define nonorientable surfaces of genus  $p$ .

Induction on  $p$  shows that *an orientable surface of genus  $p$  is compact, connected and reversible* (use Theorems 1.3 and 1.5). *It has Euler characteristic  $2 - 2p$*  (use Exercise 8, Section 5.2). Therefore *orientable surfaces of different genus are not diffeomorphic*. On the other hand induction on  $p$  and Theorem 1.4(c) shows that *two orientable surfaces of the same genus are diffeomorphic*.

In Section 9.3 we shall prove the main theorem of surface theory: every compact connected orientable surface has a genus.

Starting from two connected surfaces  $M, N$  without boundary, we construct the *connected sum* of  $M$  and  $N$  as follows. Take  $M$  and  $N$  to be disjoint. Let  $f:S^0 \times D^2 \rightarrow M \cup N$  be an embedding with  $f(1 \times D^2) \subset M$ ,  $f(-1 \times D^2) \subset N$ . Let  $W = (M \cup N)[f]$ .

The diffeomorphism class of  $W$  is independent of  $f$  provided at least one of  $M, N$  is nonorientable or reversible. In such a case we pretend  $W$  is a well-defined manifold and write  $W = M \# N$ .

We can also view  $M \# N$  as formed by gluing together  $M - \text{Int } B$  and  $N - \text{Int } D$  by a diffeomorphism  $\partial D \approx \partial B$ , where  $B \subset M$  and  $D \subset N$  are disks.

The connected sum of higher dimensional manifolds can be defined analogously.

Clearly  $M_0 \# M_1$  is orientable if and only if both  $M_0$  and  $M_1$  are orientable. It is easy to prove that if  $M_1$  is an orientable surface of genus  $p_1$ , then  $M_0 \# M_1$  is orientable with genus  $p_0 + p_1$ . In particular an orientable surface of genus  $p \geq 2$  is the connected sum  $p$  tori (Figure 9-1).

We turn to models of nonorientable surfaces. Let  $P$  denote the projective plane. A *nonorientable surface of genus  $p \geq 1$*  means any surface diffeomorphic to the connected sum of  $p$  (disjoint) copies of  $P$ . Such a surface is nonorientable.

The *Möbius band*  $B$  is the surface which is the quotient space of  $S^1 \times [-1, 1]$  under the identifications  $(x, y) \sim (-x, -y)$ . It is the simplest

- 4. (a) Every orientable surface of genus  $p$  bounds a compact 3-manifold.  
 (b) A nonorientable surface of genus  $p$  bounds a compact 3-manifold if and only if  $p$  is even. [Use Exercise 7, Section 5.2.]
- 5. The complex projective plane is not reversible. [See Exercise 18, Section 5.2.]
- \*\*6. Not every 3-manifold is reversible.
- 7. Let  $M$  be an  $n$ -manifold without boundary. Then  $M \neq S^n \approx M$ .
- 8. Let  $f: S^1 \rightarrow M$  be a loop in a surface  $M$ . Then  $f$  preserves orientation (in the sense of Section 4.4) if and only if  $\#_2(f, f) = 0$  (see Exercise 4, Section 5.2 for the mod 2 intersection number  $\#_2$ ).

### 2. Characterization of the Disk

The following result is the key to the classification of surfaces.

**2.1. Theorem.** *Let  $f: M \rightarrow \mathbb{R}$  be an admissible Morse function on a compact connected surface  $M$ . Suppose  $f$  has exactly 3 critical points, and these are of type 0, 0, 1. Then  $M \approx D^2$ .*

The strategy of proof is as follows. First we find another function  $g: N \rightarrow \mathbb{R}$  of the same kind, on a surface  $N$  which we know is diffeomorphic to  $D^2$ . Then we construct a homeomorphism from  $M$  to  $N$  using level curves and gradient lines of the two Morse functions. This homeomorphism is then smoothed to a diffeomorphism.

Before beginning the proof we discuss a method of extending diffeomorphism.

Let  $M_i$  be a complete Riemannian manifold,  $i = 0, 1$ , and  $f_i: M_i \rightarrow \mathbb{R}$  a map. For  $x \in M_i$  let  $A_i(x) \subset M_i$  be the maximal solution curve through  $x$  of the vector field  $\text{grad } f_i$ .

Let  $U_i \subset M_i$  be open and let  $G: U_0 \approx U_1$  be a diffeomorphism having the following properties: for all  $x \in U_0$ ,

- (1)  $f_1 G(x) = f_0(x)$ , and
- (2)  $G(U_0 \cap A_0(x)) = U_1 \cap A_1(Gx)$ .

We say that  $G$  preserves level surfaces and gradient lines.

Let  $U_i^* \subset M_i$  be the saturation of  $U_i$ , under the flow of  $\text{grad } f_i$ , that is:

$$U_i^* = \bigcup_{x \in U_i} A_i(x).$$

**2.2. Lemma.** *In addition to the above, suppose also that for each  $x \in U_0$ ,*

- (a)  $f_0(A_0(x)) = f_1(A_1(f_0(x)))$ ;
- (b)  $A_0(x) \cap U_0$  is connected.

Then  $G$  extends to a unique diffeomorphism  $G = U_0^* \approx U_1^*$  which satisfies (1) and (2).

*Proof.* Any critical points of  $f_0$  in  $U_0^*$  are already in  $U_0$ ; thus  $G$  is already defined in a neighborhood of such points. If  $x \in U_0^* - U_0$ , then  $A_0(x)$

contains a point  $y \in U_0$ . Define

$$G(x) = A_1(Gy) \cap f_1^{-1}(f_0(x)).$$

The intersection is nonempty by (a); it contains only one point since  $f_1$  is monotone on gradient lines; and  $G(x)$  is independent of  $y$  by (b).

It remains to prove that  $G$  is  $C^\infty$ . Let  $x \in U_0^*$ ; put  $G(x) = y$ . Then from commutativity of the diagram

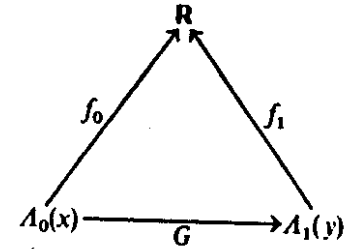

we see that

$$G|_{A_0(x)} = [f_1|_{A_1(y)}]^{-1} \circ [f_0|_{A_0(x)}].$$

Thus  $G|_{A_0(x)}$  is  $C^\infty$ . That  $G$  is globally  $C^\infty$  follows from the fact that the gradient flows are  $C^\infty$ .

QED

Notice that Lemma 2.2 is also true if  $U_0$  and  $U_1$  are open subsets of level surfaces ((b) is then trivial). The proof is the same.

Next we study the model function

$$g: \mathbb{R}^2 \rightarrow \mathbb{R}$$

$$g(x, y) = \frac{x^4}{4} - \frac{x^3}{3} - x^2 + y^2$$

$$= \int_0^x t(t+1)(t-2) dt + y^2.$$

The critical points of  $g$  are at  $(0,0)$ ,  $(-1,0)$ ,  $(2,0)$ . They are nondegenerate, of types 1, 0, 0 respectively. Note that the three critical values are distinct.

**2.3. Lemma.**  $g^{-1}(c)$  is connected if  $c \geq 0$ .

*Proof.* Note that  $g$  is proper, so  $g^{-1}(c)$  is compact. One component of the critical level  $g^{-1}(0)$  is a figure 8, and each loop of the figure 8 encloses one of the two (local) minima of  $g$ . Any other component of  $g^{-1}(0)$  would be a circle enclosing another minimum, which is impossible. Therefore  $g^{-1}(0)$  is connected. If  $c > 0$ , each component of  $g^{-1}(c)$  is a circle enclosing a minimum. But one component encloses  $g^{-1}(0)$ , hence it encloses both minima. Therefore  $g^{-1}(c)$  has only one component.

QED

**2.4. Lemma.** If  $\xi > 0$ ,  $g^{-1}(-\infty, \xi] \approx D^2$ .

*Proof.* It suffices to prove this for some large  $\xi$ , by the regular interval Theorem 6.2.2. We shall show that if  $\xi$  is large then each ray from  $(0,0)$  meets the curve  $g^{-1}(\xi)$  transversely. Since  $g^{-1}(\xi)$  is connected, this will mean  $g^{-1}(-\infty, \xi]$  is star shaped, and thus prove the lemma. Since  $\text{grad } f$  is perpendicular to  $g^{-1}(\xi)$ , it suffices to show that if  $|x|^2 + |y|^2$  is large enough then

$$\langle \text{grad } f(x,y), (x,y) \rangle \neq 0$$

But

$$\begin{aligned} \langle \text{grad } f(x,y), (x,y) \rangle &= \langle (x^3 - x^2 - 2x, 2y), (x,y) \rangle \\ &= x^2(x^2 - x - 2) + 2y^2 \end{aligned}$$

which is positive if  $x > 2$  or  $y > 3$ .

QED

Now consider the gradient flow  $\Phi_t$  of  $g$ , given by the system of differential equations

$$\begin{aligned} \frac{dx}{dt} &= x^3 - x^2 - 2x \\ \frac{dy}{dt} &= 2y. \end{aligned}$$

These can be easily solved (see Figure 9-2). It is clear that the  $x$ -axis and  $y$ -axis are invariant. The stationary points of the flow are of course the critical points of  $g$ . There are two sources,  $(-1,0)$  and  $(2,0)$ ; and one saddle,  $(0,0)$ . The flow lines are orthogonal to the level curves  $g = \text{constant}$ .

If  $y \neq 0$ , or  $y = 0$  and  $x < 1$  or  $x > 2$ , then  $|\Phi_t(x,y)| \rightarrow \infty$  as  $t \rightarrow \infty$ . If  $-1 \leq x < 0$  or  $0 < x \leq 2$  then  $\Phi_t(x,0) \rightarrow (0,0)$  as  $t \rightarrow \infty$ .

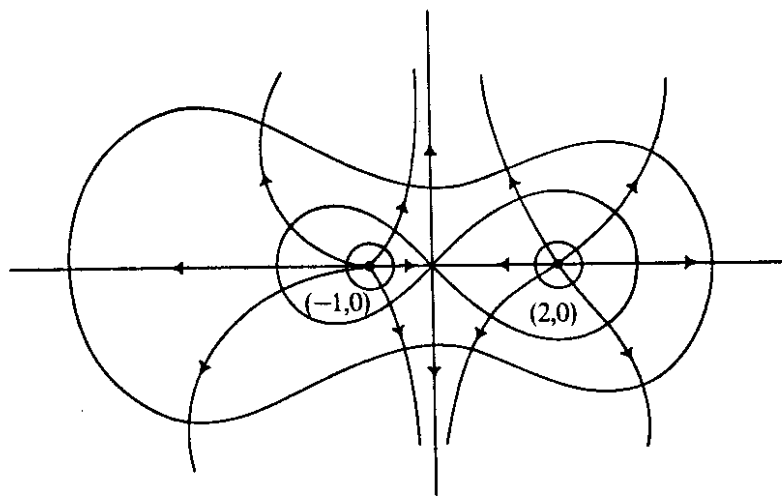

Figure 9-2. Levels and gradients.

As  $t \rightarrow -\infty$ ,  $\Phi_t(x,y) \rightarrow (-1,0)$  if  $x < 0$ ; to  $(0,0)$  if  $x = 0$ ; and to  $(2,0)$  if  $x > 0$ .

Now let  $f: M \rightarrow \mathbb{R}$  be as in Theorem 2.1. Let  $a, b, c \in M$  be the three critical points of  $f$ , with  $a$  and  $c$  local minima and  $b$  a saddle. By slightly perturbing  $f$  near  $a$  and  $c$ , if necessary, we can assume that  $f(b) > f(a) > f(c)$ .

Let  $\lambda: \mathbb{R} \rightarrow \mathbb{R}$  be a diffeomorphism such that

$$\begin{aligned} \lambda(f(a)) &= -\frac{1}{2} = g(-1,0), \\ \lambda(f(b)) &= 0 = g(0,0), \\ \lambda(f(c)) &= \frac{2}{3} = g(2,0). \end{aligned}$$

The map  $\lambda \circ f: M \rightarrow \mathbb{R}$  is a Morse function having the properties listed in Theorem 2.1. Therefore we may assume that  $f(a) = g(-1,0)$ ,  $f(b) = g(0,0)$ ,  $f(c) = g(2,0)$ .

Set  $\xi = f(\partial M) > 0$ . Then  $\xi$  is the maximum value of  $f$ , and  $f^{-1}(\xi) = \partial M$ .

We first prove that  $\partial M$  is connected. By the regular interval Theorem 6.2.2 it suffices to prove that  $f^{-1}(\epsilon)$  is connected for some  $\epsilon$ ,  $0 < \epsilon < \xi$ , since  $\partial M \approx f^{-1}(\epsilon)$ .

Give  $M$  a Riemannian metric induced by Morse charts near critical points. Let  $F_t$  be the flow of  $-\text{grad } f$ ; then  $F_t: M \rightarrow M$  is defined for all  $t \geq 0$ . For each  $x \in M$  the limit  $\bar{x} = \lim_{t \rightarrow \infty} F_t(x)$  is one of the three critical points. The sets

$$\begin{aligned} W_a &= \{x \in M: \bar{x} = a\}, \\ W_c &= \{x \in M: \bar{x} = c\} \end{aligned}$$

are disjoint open sets.

A glance at a Morse chart near the saddle  $b$  shows there are only two nonconstant trajectories limiting at  $b$ , and these intersect  $f^{-1}(\epsilon)$  in two points, say  $q_1, q_2$ . Moreover the set  $\{q_1, q_2\}$  is the common boundary in  $f^{-1}(\epsilon)$  of  $f^{-1}(\epsilon) \cap W_a$  and  $f^{-1}(\epsilon) \cap W_c$ . No component of  $f^{-1}(\epsilon)$  can be entirely in  $W_a$ , for if it were,  $W_a$  would be a component of  $M$ , contradicting connectedness of  $M$ . Similarly for  $W_c$ . Therefore each component of  $f^{-1}(\epsilon)$  must be separated by a subset of  $\{q_1, q_2\}$ . Since a single point cannot separate, each component contains both  $q_1$  and  $q_2$ . Hence there is only one component.

Let  $\varphi: U \rightarrow \mathbb{R}^2$  and  $\psi: V \rightarrow \mathbb{R}^2$  be Morse charts for  $f$  and  $g$  at  $b$  and  $(0,0)$ . We may assume that  $\varphi(U) = \psi(V)$ . Put

$$H = \varphi^{-1}\psi: V \rightarrow M.$$

Then  $H$  maps  $V$  diffeomorphically onto  $U$ , preserving level surfaces (i.e.,  $gH = f$ ). We can choose  $V$  so that  $M$  has a Riemannian metric making  $H$  an isometry (where  $V$  inherits the standard metric from  $\mathbb{R}^2$ ). Then  $H$  also preserves gradient lines.

We also choose  $V$  so that  $V$  meets each  $g$ -gradient line in a connected set; for example,  $V = \text{Int } B_\delta$  for small  $\delta > 0$ . It then follows from Theorem 2.2 that  $H$  extends to a diffeomorphism  $H: V^* \approx U^*$  between the saturation of  $V$  and  $U$ , preserving levels and gradients.

We can choose  $\psi$  so that  $H$  has the following property: as  $t \rightarrow -\infty$ , the grad  $f$  trajectory of  $H(p)$  tends to  $a$  or  $c$ , respectively, according as the grad  $g$  trajectory of  $p \in V^*$  tends to  $(-1,0)$  or  $(2,0)$ .

Fix a real number  $\alpha$  such that

$$g(2,0) < g(-1,0) < \alpha < g(0,0) = 0.$$

Let  $D, D'$  be the components of the minima  $(-1,0), (2,0)$  respectively, in the submanifold  $g^{-1}(-\infty, \alpha] \subset \mathbb{R}^2$ . Morse's lemma implies that  $D$  and  $D'$  are disks. Observe that  $\partial D$  and  $\partial D'$  are components of level curves.

Let  $\varepsilon > 0$  be very small. Let  $B_\varepsilon \subset \mathbb{R}^2$  be the square  $|x| \leq \varepsilon, |y| \leq \varepsilon$ . Let  $B_\varepsilon^*$  denote the saturation of  $B_\varepsilon$  under the gradient flow of  $g$ .

Define

$$P_\varepsilon = [B_\varepsilon^* - \text{Int}(D \cup D')] \cap g^{-1}(-\infty, \varepsilon].$$

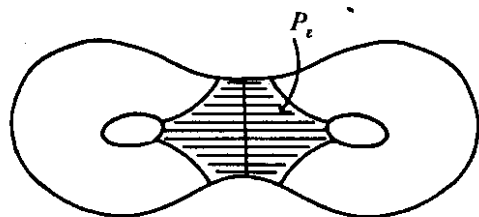

Figure 9-3.

See Figure 9-3. If  $\varepsilon$  is sufficiently small then  $B_\varepsilon \subset V$  and  $P_\varepsilon \subset V^*$ ; and also the sets

$$A = P_\varepsilon \cap D = P_\varepsilon \cap \partial D,$$

$$A' = P_\varepsilon \cap D' = P_\varepsilon \cap \partial D'$$

are (compact) arcs. Fix such an  $\varepsilon$ .

Let  $\Gamma, \Gamma'$  be the components of  $a$  and  $c$  respectively in  $f^{-1}(\infty, \alpha]$ . Then  $\Gamma$  and  $\Gamma'$  are disjoint disks.

The diffeomorphism  $H: V^* \approx U^*$  embeds the arcs  $A, A'$  in the circles  $\partial\Gamma, \partial\Gamma'$  respectively. There are diffeomorphisms  $D \approx \Gamma, D' \approx \Gamma'$  which agree with  $H$  on  $A, A'$ . To see this, identify  $D$  and  $\Gamma$  with  $D^2$  via diffeomorphisms in such a way that  $H|_A$  is transformed into an orientation preserving embedding  $H_0$  of an arc  $B \subset \partial D^2$  into  $\partial D^2$ . By isotopy of disks,  $H_0$  is isotopic to the inclusion of  $B$  in  $\partial D^2$ , and by isotopy extension  $H_0$  therefore extends to a diffeomorphism of  $D^2$ . Hence  $H$  extends to a diffeomorphism  $D \approx \Gamma$ , and likewise for  $D'$  and  $\Gamma'$ .

In this way we obtain a diffeomorphism

$$G: D \cup D' \approx \Gamma \cup \Gamma'$$

$$G(D) = \Gamma, \quad G(D') = \Gamma'.$$

We now extend the restriction

$$G: \partial D \cup \partial D' \approx \partial\Gamma \cup \partial\Gamma'$$

to a diffeomorphism of saturations

$$F: (\partial D \cup \partial D')^* \rightarrow (\partial\Gamma \cup \partial\Gamma')^*,$$

such that  $F$  preserves level curves and gradient lines. For this we use Lemma 2.2 and the remark following its proof.

Notice that  $F$  and  $H$  agree on

$$(\partial D \cup \partial D')^* \cap P_\varepsilon$$

since they agree on  $A \cup A'$ , and both preserve level curves and gradients.

Define a map

$$K: g^{-1}(-\infty, \xi] \rightarrow M$$

by

$$K = \begin{cases} G & \text{in } D \cup D' \\ H & \text{in } P_\varepsilon \\ F & \text{elsewhere.} \end{cases}$$

Then  $K$  is well defined. It is easy to see that  $K$  is surjective and injective, hence  $K$  is a homeomorphism. Moreover  $K$  maps  $D \cup D'$  and  $g^{-1}(-\infty, \xi] - \text{Int}(D \cup D')$  diffeomorphically.

From the smoothing Theorem 8.1.9 we conclude that  $N \approx M$ . Since also  $N \approx D^2$  by Theorem 2.4, the proof of Theorem 2.1 is complete.

QED

In the proof of Theorem 2.1 we did not use Theorems 8.3.3 and 8.3.4, or any other special properties of manifolds of dimension 1 or 2. The same argument, with only notational changes, proves the following generalization of Theorem 2.1:

**2.5. Theorem.** *Let  $f: M \rightarrow \mathbb{R}$  be an admissible Morse function on a compact connected  $n$ -manifold  $M$ . Suppose  $f$  has exactly 3 critical points, of types 0, 0, 1. Then  $M \approx D^n$ .*

### Exercises

1. The proof of Theorem 2.1 can be varied slightly to prove the following. Let  $f: M \rightarrow \mathbb{R}, g: D^2 \rightarrow \mathbb{R}$  be admissible Morse each having only three critical points, and these types 0, 0, 1. Suppose that  $f$  and  $g$  take the same values at corresponding critical points, and that  $f(\partial M) = g(\partial D^2)$ . Then there is homeomorphism  $h: D^2 \rightarrow M$  such that  $fh = g$ . Moreover  $M$  has a Riemannian metric for which  $h$  maps gradient lines of  $g$  to gradient lines of  $f$ .

2. Let  $a < 0 < b$ . Define a polynomial map in two variables:

$$P_{a,b}: \mathbb{R} \times \mathbb{R}^{n-1} \rightarrow \mathbb{R},$$

$$P_{a,b}(x,y) = \int_0^x s(s-a)(s-b) ds + |y|^2.$$

(a)  $P_{a,b}$  is a Morse function having local minima at  $(a,0)$  and  $(b,0)$ , a type 1 saddle at  $(0,0)$ , and no other critical points.

- (b)  $P_{a,b}(a,0) \neq P_{a,b}(b,0)$  if and only if  $a \neq -b$ .
- (c) Let  $\alpha$  be in the image of  $P_{a,b}$ . Then  $P_{a,b}^{-1}(-\infty, \alpha]$  is connected if and only if  $\alpha \geq 0$ .
- (d)  $P_{a,b}^{-1}(-\infty, \alpha] \approx D^k$  if  $\alpha > 0$ .

- 3. Let  $M$  be a compact connected surface without boundary which admits a Morse function having just four critical points, exactly one of which is a saddle. Then  $M \approx S^2$ .
- 4. Let  $f: M \rightarrow \mathbb{R}$  be a Morse function on a connected compact Riemannian manifold without boundary. Assume the Riemannian metric comes from Morse charts near critical points. Then if  $f$  has more than one local minimum, there exist two local minima  $a, b$  and a type 1 critical point  $p$ , with the following property: one branch of the unstable manifold of  $p$  (for  $\text{grad } f$ ) tends to  $a$  and the other branch tends to  $b$ .
- 5. [Smale]. Let  $M$  be a compact connected manifold. If  $\partial M = \emptyset$  then  $M$  has a Morse function with only 1 maximum and 1 minimum. [Use Exercise 4 and Theorem 2.4.]

### 3. The Classification of Compact Surfaces

We begin by investigating neighborhoods of a critical level of an admissible Morse function  $f$  on a compact connected surface  $M$ . Let  $p \in M$  be a saddle (critical point of index 1). Suppose that  $f(p) = 0$  and that  $\varepsilon > 0$  is such that  $p$  is the only critical point in  $N = f^{-1}[-\varepsilon, \varepsilon]$ . Assume that  $N$  is connected. Put

$$\begin{aligned} C_- &= f^{-1}(-\varepsilon) \\ C_0 &= f^{-1}(0) \\ C_+ &= f^{-1}(\varepsilon) \end{aligned}$$

Then  $C_-$  and  $C_+$  are compact 1-manifolds without boundary;  $C_- \cup C_+ = \partial N$ . Since  $N$  is connected,  $C_0$  must be connected. Therefore  $C_0$  is a figure 8.

Here are two examples. In each  $f$  has one saddle and one minimum in  $M$ . (1)  $M$  is a U-shaped cylinder in  $\mathbb{R}^3$  and  $f$  is the height function shown in Figure 9-4. (2)  $M$  is a Möbius band,  $f$  has the level curves shown in Figure 9-5.

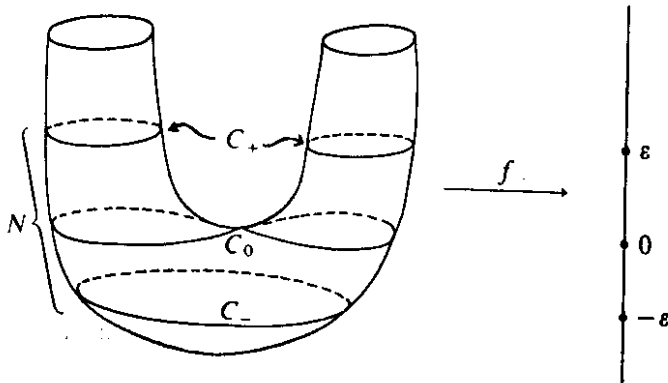

Figure 9-4.

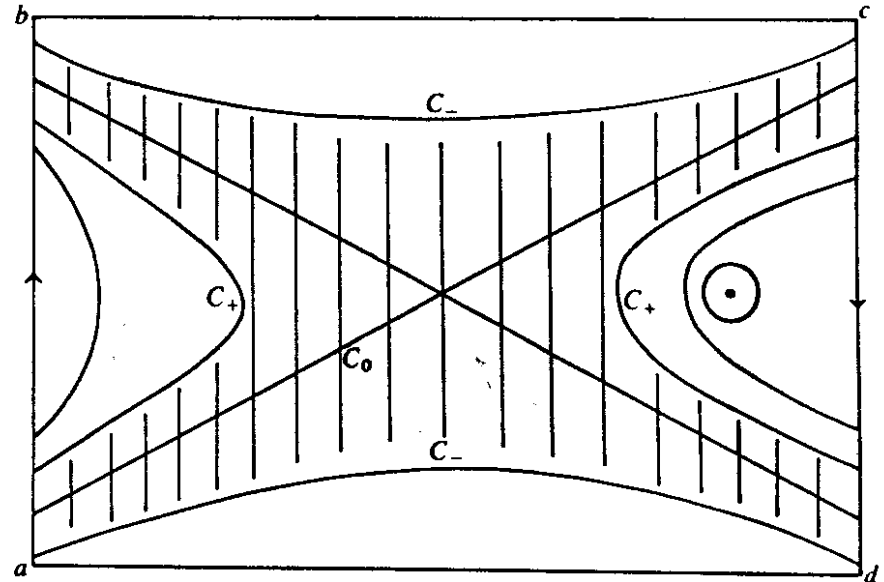

Figure 9-5.  $ab$  is identified with  $cd$ .  $N$  is shaded.

Note that example (1) is also obtained from Figure 9-5 if  $ab$  is identified with  $dc$  to make a cylinder.

In fact these are the only examples of such an  $N$ , up to diffeomorphism. We do not need to prove this, but only the following consequences:

- 3.1. Lemma. Let  $f$  and  $N$  be as above. Then either
  - (a)  $N$  is orientable and  $\partial N$  has three components; or
  - (b)  $N$  is nonorientable and  $\partial N$  has two components.

Proof. A Morse chart at  $p$  shows that  $p$  has an X-shaped neighborhood in  $C_0$ . Label the four branches of the X by the quadrants they lie in (Figure 9-6). The arrows in Figure 9-6 represent  $\text{grad } f$ . The key question is: how

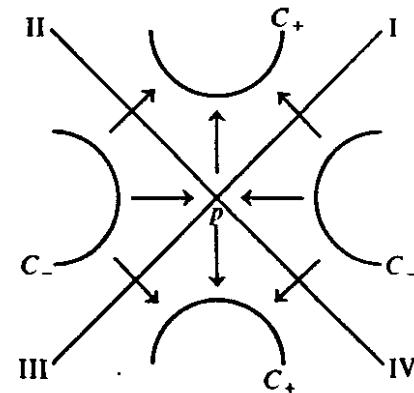

Figure 9-6. Levels and gradients near a saddle.

are the four branches I, II, III, IV connected in  $C_0$ ? Suppose I connects to IV. The resulting loop  $\lambda$  based at  $p$  *preserves orientation*, as can be seen by considering the orientation defined by the tangent to the loop and  $\text{grad } f$ . (Perturb the loop slightly away from  $p$  to make it smoothly embedded. See Figure 9-7.) It is clear that in this case II must connect to III. Notice that

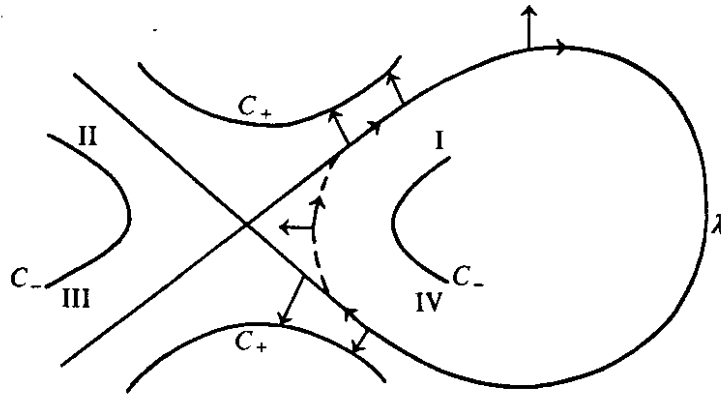

Figure 9-7. The loop  $\lambda$  preserves orientation.

$C_+$  is connected, for otherwise we could follow the top part of  $C_+$  around the loop and some gradient line would intersect  $C_+$  twice. This is impossible because  $C_+ = f^{-1}(\epsilon)$ . (See Figure 9-8.)

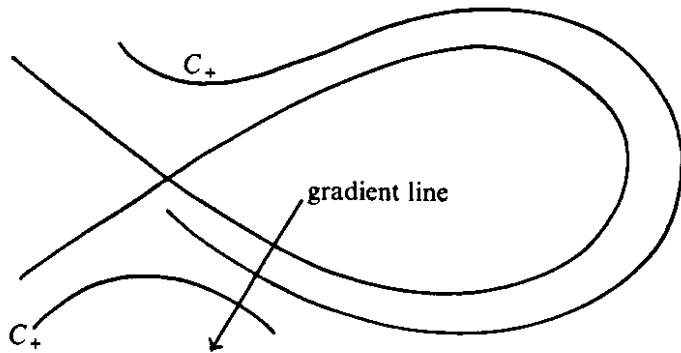

Figure 9-8. Impossible, because  $C_+ = f^{-1}(\epsilon)$ .

For similar reasons, the right and left branches of  $C_-$  must each close up, forming two components. If I connects to II then  $C_-$  is connected and  $C_+$  has two components.

Now suppose I connects to III. The resulting loop then *reverses* orientation (Figure 9-9). In this case the two branches of  $C_+$  connect up;  $C_+$  is

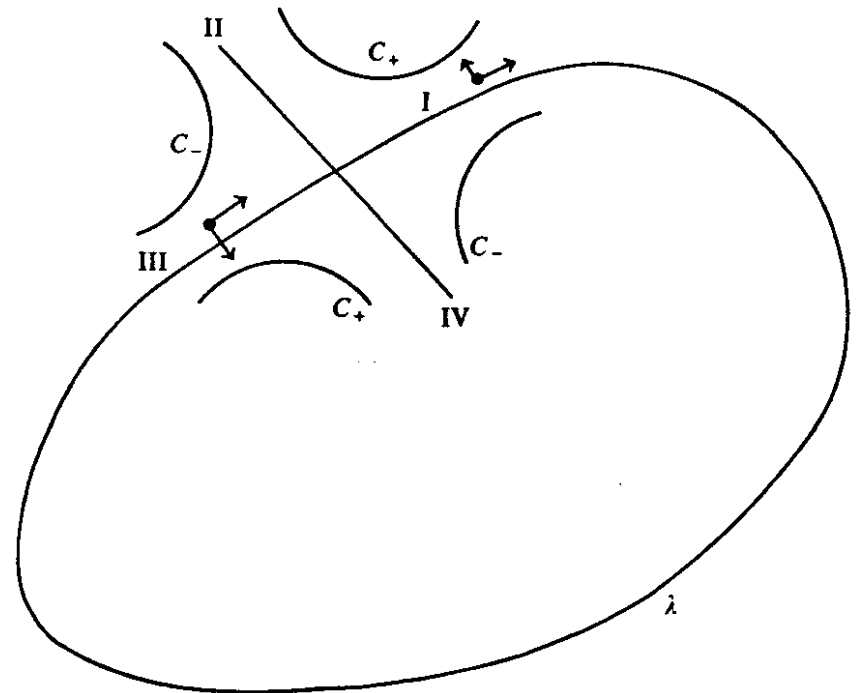

Figure 9-9.  $\lambda$  reverses orientation.

connected. Likewise, II connects to IV and  $C_-$  is connected.

QED

Let  $B_1, \dots, B_k \subset D^2 - \partial D^2$  be disjoint embedded disks. Put  $H_k = D^2 - \cup \text{Int } B_i$ , and  $H_0 = D^2$ .

A disk with  $k$  holes means a surface diffeomorphic to  $H_k$ , that is, an orientable model surface of genus 0 and  $k + 1$  boundary circles. Any two such surfaces (for the same  $k$ ) are diffeomorphic. Since the Euler characteristic of  $H_k$  is  $1 - k$ ,  $H_k$  is not diffeomorphic to  $H_\ell$  for  $k \neq \ell$ . Note that  $H_1 \approx S^1 \times I$ .

Returning to the situation of Theorem 3.1, we have:

**3.2. Lemma.** *Let  $N$  be as in Theorem 3.1(a). Then  $N$  is a disk with 2 holes.*

*Proof.* We may assume  $C_-$  has two components and  $C_+$  has one. Glue disks onto  $N$  along each of the components of  $C_-$ , to obtain a new manifold  $V$ . Define a map  $g: V \rightarrow \mathbb{R}$  which is  $f$  on  $N$ , and on each disk is  $x^2 + y^2 - 1 - \epsilon$ , when the disk is identified with  $D^2$ . The differential structure on  $V$  can be chosen so that  $g$  is  $C^\infty$ . (Use collars determined by level curves and gradient lines.) Then  $g$  is an admissible Morse function on  $V$  having one saddle and two minima. By Theorem 2.1,  $V \approx D^2$ . Therefore  $N \approx H_2$ .

QED



A saddle is a critical point of index 1. We restate Theorem 3.2 as:

**3.3. Theorem.** *Let  $M$  be a compact connected orientable surface admitting a Morse function having only one critical point, a saddle. Then  $M$  is a disk with 2 holes; moreover  $f$  takes its maximum and minimum on  $\partial M$ .*

It is now easy to classify compact orientable surfaces admitting a Morse function with only one saddle:

**3.4. Theorem.** *Let  $f: M \rightarrow \mathbb{R}$  be an admissible Morse function on a compact connected orientable surface. Suppose  $f$  has exactly one saddle (and perhaps other critical points of type 0 or 2). Then  $M$  is diffeomorphic to either  $S^2$ ,  $D^2$ ,  $S^1 \times I$  or  $H_2$ . If  $f|_{\partial M}$  is constant then  $M \cong H_2$ .*

*Proof.* Delete from  $M$  the interior of disjoint disks around the critical points (if any) of types 0 and 2. Do this in such a way that the disks contain no other critical points, and their boundaries are components of level curves. The resulting manifold  $W$  is diffeomorphic to  $H_2$  by Theorem 3.3. If  $f$  has no critical points of type 0 or 2, then  $M = W$ ; however, this cannot happen if  $f|_{\partial M}$  is constant. If there are critical points of types 0 or 2, then  $M$  is obtained from  $W$  by capping some of the boundary circles with disks. This produces  $S^1 \times I$ ,  $D^2$  or  $S^2$ .

QED

We now come to the classification of compact orientable surfaces. First we assume no boundary.

**3.5. Theorem.** *Let  $M$  be a compact connected orientable surface without boundary. Then there is a unique integer  $p \geq 0$  such that  $M$  is an orientable surface of genus  $p$  as defined in Section 9.1 (a "sphere with  $p$  handles"). The Euler characteristic of  $M$  determines  $p$  by the formula  $\chi(M) = 2 - 2p$ . In particular  $\chi(M)$  is even and  $\leq 2$ .*

*Proof.* We proceed by induction on the number  $v$  of saddles of a Morse function  $f: M \rightarrow \mathbb{R}$ .

Suppose  $f$  has no saddles. Give  $M$  a Riemannian metric. Let  $P \subset M$  be the set of minima. Each trajectory of  $\text{grad } f$  in  $M - P$  tends toward a maximum. The basin of attraction of each maximum is an open set; but it is also closed since different basins are disjoint. Since  $M - P$  is connected, there is only one maximum. Similarly there is only one minimum. Hence  $M \cong S^2$  by Theorem 8.3.4.

Let  $v = k > 0$  and suppose inductively that the theorem is true whenever  $M$  admits a Morse function having fewer than  $k$  saddles. We may assume  $f$  separates critical points; there is then a unique saddle  $p$  such that  $f(p) < f(q)$  for every saddle  $q \neq p$ .

Let  $f(p) = \alpha$  and let  $\beta > \alpha$  be such that  $p$  is the only critical point in  $f^{-1}[\alpha, \beta]$ .

Let  $V$  be the component of  $p$  in  $f^{-1}(-\infty, \beta]$ . Notice that  $\partial V \subset f^{-1}(\beta)$ . Since  $f|_V$  has only one saddle, we can apply Theorem 3.4. Since  $\partial V \neq \emptyset$ , we conclude that  $V \cong S^2$ . Also  $V \cong H_2$  since  $f|_{\partial V}$  is constant. Thus  $V \cong D^2$  or  $V \cong S^1 \times I$ .

Suppose  $V \cong D^2$ . Then we can define a new Morse function  $g: M \rightarrow \mathbb{R}$ , equal to  $f$  on  $M - V$ , and having only one critical point in  $V$  (a minimum). Since  $g$  has only  $k - 1$  saddles, it follows from the induction hypothesis that the theorem is true for  $M$ .

Suppose finally that  $V \cong S^1 \times I$ . Then  $\partial V = S^1 \times \{0, 1\}$ . Let  $M_0$  be obtained from  $M$  by capping  $\partial V$  with two disks. We can define  $f$  on the disks to get a Morse function  $f_0: M_0 \rightarrow \mathbb{R}$  having fewer saddles than  $f$ . By the induction hypothesis  $M_0$  is an orientable surface of some genus  $q$ . Since  $M$  is evidently obtained from  $M_0$  by attaching a handle,  $M$  has genus  $q + 1$ . This completes the induction.

The uniqueness of the genus and the formula for the Euler characteristic were proved in Section 9.1.

QED

It is now easy to give a geometric interpretation to the genus.

**3.6. Theorem.** *Let  $M$  be an orientable surface of genus  $p$ . Then there exist  $p$  disjoint circles in  $M$  whose complement is connected; but any  $p + 1$  disjoint circles disconnect  $M$ .*

*Proof.* If  $p = 0$  we may assume  $M = S^2$ . The first part of the conclusion is vacuous and the second follows from Theorem 4.4.6.

Suppose  $C_1, \dots, C_q$  are disjoint circles in  $M$ ,  $q \geq 1$ , and  $M - \cup C_i$  is connected. Let  $N_1, \dots, N_q$  be disjoint closed tubular neighborhoods of  $C_1, \dots, C_q$ . Let  $V = M - \cup \text{Int } N_i$ . Let  $W$  be obtained from  $V$  by capping the  $2q$  boundary circles of  $V$  with disks. Notice that  $W$  is connected and orientable, and that  $M$  is obtained from  $W$  by attaching  $q$  handles. Let  $W$  have genus  $g \geq 0$ . Then  $M$  has genus  $g + q = p$ . It follows that  $q \leq p$ .

QED

The classification of compact orientable  $\partial$ -surfaces is as follows:

**3.7. Theorem.** *Let  $M$  be a connected compact orientable surface of Euler characteristic  $\chi$ . Suppose  $\partial M$  has  $k > 0$  boundary components. Then  $\chi + k$  is even. Let  $p = 1 - (\chi + k)/2$ . Then  $M$  is diffeomorphic to the surface obtained from an orientable surface of genus  $p$  by removal of the interiors of  $k$  disjoint disks.*

*Proof.* Cap the boundary circles of  $M$  to produce an orientable surface  $W$ . Then the Euler characteristic  $\chi + k$ . Therefore if  $W$  has genus  $p$ , we find that  $\chi + k = 2 - 2p$ .

QED

The number  $p$  associated to the  $\partial$ -surface  $M$  by Theorem 3.7 is called the *genus of  $M$* .

We turn to nonorientable surfaces.

**3.8. Lemma.** *Every nonorientable surface  $N$  contains a submanifold which is a Möbius band.*

*Proof.* Pick some orientation reversing loop  $f: S^1 \rightarrow N - \partial N$ . We can assume  $f$  is an immersion with clean double points. It is easy to see that  $f(S^1)$  contains a topologically embedded circle which reverses orientation. This circle is smooth except for finitely many corners. The corners can be smoothed out. In this way we construct a smoothly embedded circle which reverses orientation. It is easy to see that a tubular neighbor of such a circle is a Möbius band.

QED

**3.9. Lemma.** *Let  $N$  be a compact connected nonorientable surface. Then there is a unique integer  $p > 0$  such that  $M$  contains  $p$ , but not  $p + 1$ , disjoint Möbius bands.*

*Proof.* It suffices to exhibit an integer  $n$  such that no  $n + 1$  Möbius bands in  $N$  can be disjoint.

Suppose  $B \subset N$  is a Möbius band. Then  $\partial B$  is connected; hence  $N - B$  is connected. Therefore if  $B_1, \dots, B_p \subset N$  are disjoint Möbius bands, it follows that  $N - \cup B_i$  is connected.

Let  $\pi: \tilde{N} \rightarrow N$  be the orientable double covering of  $N$ . Then  $\pi^{-1}(B)$  is a cylinder in  $\tilde{N}$  if  $B \subset N$  is a Möbius band.

Let  $V \subset N$  be a connected two-dimensional submanifold. Then  $\pi^{-1}(V)$  is connected if and only if  $V$  is nonorientable. Hence  $\pi^{-1}(V)$  is connected if and only if  $V$  contains a Möbius band.

Let the genus of  $\tilde{N}$  be  $n - 1 \geq 0$ .

Let  $B_1, \dots, B_n$  be disjoint Möbius bands in  $N$ . Then  $\pi^{-1}(B_1), \dots, \pi^{-1}(B_n)$  are disjoint cylinders in  $\tilde{N}$ ; they contain  $n$  disjoint embedded circles. Therefore  $\tilde{N} - \cup \pi^{-1}(B_i)$ , which is  $\pi^{-1}(N - \cup B_i)$ , is disconnected by Theorem 3.6. It follows that  $N - \cup B_i$  is orientable and contains no Möbius band.

QED

We call the integer  $p$  of Theorem 3.9 the *Möbius number of  $N$* .

**3.10. Theorem.** *Let  $N$  be a compact connected nonorientable surface without boundary, having Möbius number  $p$ . Then  $N$  is a nonorientable surface of genus  $p$ .*

*Proof.* Let  $M_0 \subset N$  be obtained by cutting out the interiors of  $p$  disjoint Möbius bands. Then  $M_0$  is orientable. Cap off  $\partial M_0$  with  $p$  disks to obtain an orientable surface  $M$ ; let  $M$  have genus  $g$ . Clearly  $N$  is formed by attaching  $p$  crosscaps to  $M$ . By Theorems 1.7 and 1.8  $N$  is a nonorientable surface of

genus  $2g + p$ . But this implies that the Möbius number of  $N$  is at least  $2g + p$ . Therefore  $2g = 0$  and  $M$  is a sphere.

QED

We conclude with a convenient diffeomorphism criterion:

**3.11. Theorem.** *Two connected compact surfaces are diffeomorphic if and only if they have the same Euler characteristic and the same number of boundary components, and both are orientable or both are nonorientable.*

*Proof.* In the orientable case this follows from Theorem 3.7. In the nonorientable case, glue Möbius bands to the boundary components; this preserves the Euler characteristic. The theorem now follows from Theorem 3.10.

### Exercises

1. A compact surface embedded in  $\mathbb{R}^2$  is diffeomorphic to  $D^2$  or some  $H_k$ .
- \*2. Let  $M$  be a surface and  $C \subset M$  a circle. If  $C$  is contractible to a point in  $M$  then  $C$  bounds a disk in  $M$ .
- \*3. A connected noncompact simply connected surface  $M$  without boundary, is diffeomorphic to  $\mathbb{R}^2$ . [Let  $f: M \rightarrow \mathbb{R}_+$  be a proper Morse function. For every regular value  $\alpha \in f(M)$ , the submanifold  $M_\alpha = f^{-1}(-\infty, \alpha]$  is a disk with holes. For sufficiently large  $\beta > \alpha$ , every boundary circle of  $M_\alpha$  bounds a disk in  $M_\beta$ . Therefore  $M$  is an increasing union of disks:  $M = \cup D_i$ ,  $D_i \subset \text{Int } D_{i+1}$ . And  $D_{i+1} - \text{Int } D_i \approx S^1 \times I$  so a diffeomorphism  $M \approx \mathbb{R}^2$  can be built up successively over the  $D_i$ .]
4. (a) Let  $M$  be an orientable surface of genus  $p$  and  $C_1, C_2$  circles in  $M$ . Suppose neither circle separates  $M$ . Then there is a diffeomorphism  $f: (M, C_1) \approx (M, C_2)$ . [Represent  $M$  as a sphere with handles so that  $C_i$  goes around a handle in a standard way.]  
(b) Suppose both  $C_1$  and  $C_2$  separate  $M$ . In what circumstances is the conclusion of (a) true?
5. (a) Let  $M = T - \text{Int } D$  where  $D \subset T$  is a disk in a torus. Then  $M$  and  $H_2$  are not homeomorphic but  $M \times I$  and  $H_2 \times I$  are homeomorphic.  
(b) The doubles of  $M$  and  $H_2$  are diffeomorphic.
6. Two compact oriented surfaces which are diffeomorphic, are diffeomorphic by an orientation preserving diffeomorphism.
7. Every compact nonorientable  $\partial$ -surface admits a diffeomorphism that reverses orientation of its boundary.
- \*8. Let  $C, C'$  be embedded circles in the sphere  $S^2 = \partial D^3$ . Then every diffeomorphism  $f: C \approx C'$  extends to a diffeomorphism of  $D^3$ . [ $C$  and  $C'$  bound disks in  $S^2$  over which  $f$  can be extended; etc.]
9. The cobordism groups in dimension 2 are:  $\Omega^2 = 0$ ,  $\mathfrak{R}^2 = \mathbb{Z}_2$ .
10. If  $M$  is an orientable surface of genus  $p$ , any  $2p + 1$  circles in  $M$  which meet each other transversely (or are disjoint) separate  $M$ .
11. What are the analogues of Theorem 3.6 and Exercise 10 for nonorientable surfaces?
12. In a compact nonorientable surface every maximal set of disjoint Möbius bands has the same cardinality.

13. Let  $M$  be a connected noncompact surface. If  $K \subset M$  is compact let  $n(K)$  be the number of components  $U$  of  $M - K$  such that  $U$  is not compact. Let  $w$  be the supremum of  $n(K)$  as  $K$  varies over all compact sets. We call  $w$  the number of ends of  $M$ .

- The number of ends is a diffeomorphism invariant
- $\mathbb{R}^2$  has 1 end.
- For every cardinal number  $k$  less than or equal to that of  $\mathbb{R}$ , there is a surface having  $k$  ends.
- A noncompact connected surface  $M$  has only a finite number of ends, and has finite connectivity (compare Exercise 17), if and only if there is a compact surface  $N$  such that  $M \approx N - \partial N$ .

\*14. Let  $M$  be a connected surface and  $\{S_i\}$  an uncountable collection of circles in  $M$ . Then  $M - S_j \cup S_k$  is disconnected for some  $j, k$ . [Hint: let  $\{f_\alpha: S^1 \hookrightarrow M\} = Y$  be an uncountable collection of embeddings. Prove that  $C_w(S^1, M)$  is separable and use this to show that  $Y$  contains one of its limit points.]

\*15.  $\mathbb{R}^3$  does not contain an uncountable collection of disjoint Möbius bands [see hint to Exercise 14].

\*16. Let  $f: M \rightarrow N$  be a map of degree  $d$  between compact connected oriented surfaces without boundary. What relations, if any, exist between  $d$ , the genus of  $M$  and the genus of  $N$ ?

\*17. The connectivity  $c(M)$  of a compact surface  $M$  is the integer  $c \geq 0$  (if it exists) having the following property. Let  $V \subset M$  be the union  $V_1 \cup \cdots \cup V_r$  where each  $V_i$  is a neat arc, or a circle in  $M - \partial M$ , and  $V_i \cap V_j$  for  $i \neq j$ . Suppose  $M - V$  is connected. Then  $r \leq c$ , and if  $r < c$   $V$  is a proper subset of another set  $V'$  of the same type. (Riemann's connectivity is  $c(M) + 1$ .)

- If  $\partial M$  has  $b$  components then  $c(M) = 2 - \chi(M) - b$ .
- $c(M)$  is the dimension over  $\mathbb{Z}_2$  of  $H_1(M, \partial M; \mathbb{Z}_2)$ .
- Express  $c(M)$  in terms of  $b$  and the genus of  $M$ .

## Bibliography

- Abraham, R.  
1. Transversality in manifolds of mappings. *Bull. Amer. Math. Soc.* 69 (1963), 470-474.
- Abraham, R., and Robbins, J.  
1. *Transversal Mappings and Flows*. W. A. Benjamin, Inc., New York, 1967.
- Alexandroff, P. S., and Hopf, H.  
1. *Topologie I*. Springer-Verlag, Berlin, 1935.
- Artin, M., and Mazur, B.  
1. On periodic points. *Annals of Math.* 81 (1965), 81-99.
- Bochner, S.  
1. Analytic mapping of compact Riemann spaces into Euclidean space. *Duke Math. J.* 3 (1937), 339-354.
- Brouwer, L. E. J.  
1. Über Abbildungen von Mannfaltigkeiten. *Math. Ann.* 71 (1912), 97-115.
- Brown, A. B.  
1. Functional dependence. *Trans. Amer. Math. Soc.* 38 (1935), 379-394.
- Brown, M.  
1. The monotone union of open  $n$ -cells is an open  $n$ -cell. *Proc. Amer. Math. Soc.* 12 (1961), 812-814.  
2. Locally flat embeddings of topological manifolds. *Annals of Math.* 75 (1962), 331-340.
- Cerf, J.  
1. *Sur les Difféomorphismes de la Sphère de Dimension Trois* ( $\Gamma_4 = 0$ ). Lecture Notes in Mathematics, Vol. 53. Springer-Verlag, New York, 1968.
- Dold, A.  
1. *Lectures on Algebraic Topology*. Springer-Verlag, New York, 1974.
- Dubovickii, A. Ya.  
1. On differentiable mappings of an  $n$ -dimensional cube into a  $k$ -dimensional cube. *Mat. Sbornik N.S.* 32 (74) (1953), 443-464 [in Russian].
- von Dyck, W.  
1. Beiträge zur Analysis Situs I. Ein- und zwei-dimensionale Mannfaltigkeiten. *Math. Ann.* 32 (1888), 457-512.
- Grauert, H.  
1. On Levi's problem and the imbedding of real analytic manifolds. *Annals of Math.* 68, 460-472.
- Hadamard, J.  
1. Sur quelques applications de l'indice de Kronecker. Appendix to J. Tannery, *Théorie des Fonctions*, Vol. 2, 2nd Edition. Paris, 1910.
- Hanner, O.  
1. Some theorems on absolute neighborhood retracts. *Arkiv Mat.* 1 (1952), 389-408.
- Harrison, J.  
1. Continued fractals and the Seifert Conjecture. *Bull. Amer. Math. Soc.* 13 (1985), 147-153.
- Heegard, P.  
1. Sur l'Analysis Situs. *Bull. Soc. Math. de France* 44 (1916), 161-242. [Translated from: Forstudier til en topologisk teori for de algebraiske Sammenhang. Dissertation, Copenhagen, 1898.]

- Hirsch, M. W.
1. Immersion of manifolds. *Trans. Amer. Math. Soc.* 93 (1959), 242–276.
  2. On imbedding differentiable manifolds in euclidean space. *Annals of Math.* 73 (1961), 566–571.
  3. A proof the nonretractability of a cell onto its boundary. *Proc. Amer. Math. Soc.* 14 (1963), 364–365.
  4. The imbedding of bounding manifolds in euclidean space. *Annals of Math.* 74 (1961), 494–497.
  5. (with Mazur, B.) *Smoothings of Piecewise Linear Manifolds*. Annals Study 80. Princeton University Press, Princeton, 1974.
- Hirsch, M. W., and Smale, S.
1. *Differential Equations, Dynamical Systems and Linear Algebra*. Academic Press, New York, 1974.
- Hopf, H.
1. Systeme symmetrischer Bilinearformen und euklidische Modelle der projectiven Räume. *Vierteljahrsschr. naturforschende Gesellschaft Zurich* 85 (1940), 165–177.
- Hurewicz, W. and Wallman, H.
1. *Dimension Theory*. Princeton University Press, Princeton, 1948.
- James, I. M.
1. Euclidean models of projective spaces. *Bull. London Math. Soc.* 3 (1971), 257–276.
- Jordan, C.
1. Sur les déformations des surfaces. *J. de Math.* (2) XI (1866), 105–109.
- Kervaire, M.
1. A manifold which does not admit any differentiable structure. *Comm. Math. Helv.* 34 (1960), 304–312.
- Kneser, H., and Kneser, M.
1. Reell-analytische Strukturen der Alexandroff-Geraden. *Arch. d. Math.* 9 (1960), 104–106.
- Koch, W., and Puppe, D.
1. Differenzbar Strukturen auf Mannifaltigkeiten ohne abzählbare Basis. *Arch. d. Math.* 19 (1968), 95–102.
- Kronecker, L.
1. Über Systeme von Funktionen mehrerer Variablen. *Monatsberichte Berl. Akad.* (1869), 159–193 and 688–698.
- Kuiper, N. H.
1.  $C^1$ -equivalence of functions near isolated critical points. In R. D. Anderson, *Symposium on Infinite Dimensional Topology*, Annals Study 69. Princeton University Press, Princeton, 1972.
- Lang, S.
1. *Introduction to Differentiable Manifolds*. Interscience, New York, 1962.
- Lefschetz, S.
1. *Topology*. American Mathematical Society Colloquium Publications, Vol. 12, New York, 1930.
- Lickorish, W. B. R.
1. A representation of orientable combinatorial 3-manifolds. *Annals of Math.* 76 (1962), 531–540.
- Milnor, J.
1. On manifolds homeomorphic to the 7-sphere. *Annals of Math.* 64 (1956), 399–405.
  2. *Topology from the Differentiable Viewpoint*. University of Virginia Press, Charlottesville, 1966.
  3. *Morse Theory*. Annals Study 51. Princeton University Press, Princeton, 1963.
  4. A survey of cobordism theory. *Enseignement Math.* 8 (2) (1962), 16–23.
- Möbius, A. F.
1. Theorie der elementaren Verwandtschaft. *Leipziger Sitzungsberichte math.-phys. Classe* 15 (1869). [Also in *Werke*, Bd. 2.]

- Morrey, C. B.
1. The analytic embedding of abstract real-analytic manifolds. *Annals of Math.* 68 (1958), 159–201.
- Morse, A. P.
1. The behavior of a function on its critical set. *Annals of Math.* 40 (1939), 62–70.
- Morse, M.
1. Relations between the critical points of a real analytic function of  $n$  independent variables. *Trans. Amer. Math. Soc.* 27 (1925), 345–396.
  2. *The Calculus of Variations in the Large*. American Mathematical Society Colloquium Publications, Vol. 18, New York, 1934.
- Munkres, J. R.
1. *Elementary Differential Topology*. Annals Study 54. Princeton University Press, Princeton, 1963.
  2. Differentiable isotopies on the 2-sphere. *Mich. Math. J.* 7 (1960), 193–197.
- Nash, J.
1. Real algebraic manifolds. *Annals of Math.* 56 (1962), 405–421.
- Palais, R.
1. Morse theory on Hilbert manifolds. *Topology* 2 (1963), 299–340.
- Poincaré, H.
1. Analysis situs. *J. Ecole Polytechnique, Paris* 1 (2) (1895), 1–123. [Also in *Oeuvres*, t. 6.]
  2. Complément à l'analysis situs. *Rendiconti Circolo Matematico, Palermo* 13 (1899), 285–343. [Also in *Oeuvres*, t. 6.]
  3. Deuxième complément à l'analysis situs. *Proc. London Math. Soc.* 32 (1900), 277–308. [Also in *Oeuvres*, t. 6.]
  4. Cinquième complément à l'analysis situs. *Rendiconti, Circolo Matematico, Palermo* 18 (1904), 45–110. [Also in *Oeuvres*, t. 6.]
- Pontryagin, L. S.
1. Smooth manifolds and their applications in homotopy theory. *Amer. Math. Soc. Translations, Ser. 2, Vol. 11* (1959), 1–114 [translated from *Trudy. Inst. Steklov* 45 (1955)].
  2. *Foundations of Combinatorial Topology*. Graylock Press, Rochester, 1952.
- Riemann, G. F. B.
1. Allgemeine Voraussetzungen und Hilfsmittel für die Untersuchung von Funktionen unbeschränkt veränderlichen Grössen. *J. reine und angewandte Math.* 54 (1857), 103–4. [Partly translated in D. E. Smith, *A Source Book in Mathematics*, Vol. 2. Dover Publications, New York, 1959.]
  2. Über die Hypothesen welche der Geometrie zugrunde liegen. *Abh. Gesellschaft Wiss. Göttingen* 13 (1868), p. 1 et. seq. Also in *Werke*, 2nd Edition, p. 272 et. seq. [Translated in D. E. Smith, *A Source Book in Mathematics*, Vol. 2. Dover Publications, New York, 1959.]
- Sard, A.
1. The measure of the critical points of differentiable maps. *Bull. Amer. Math. Soc.* 48 (1942), 883–890.
- Schweitzer, P. A.
1. Counterexamples to the Seifert conjecture and opening closed leaves of foliations. *Annals of Math.* 100 (1974), 386–400.
- Shiata, M.
1. *Nash Manifolds*. Lecture Notes in Mathematics, Vol. 1269. Springer-Verlag, New York, 1987.
- Shub, M., and Sullivan, D.
1. A remark on the Lefschetz fixed point formula for differentiable maps. *Topology* 13 (1974), 189–191.

Smale, S.

1. Generalized Poincaré's conjecture in dimensions greater than four. *Annals of Math.* 74 (1961), 391–406.
2. Diffeomorphisms of the 2-sphere. *Proc. Amer. Math. Soc.* 10 (1959), 621–626.
3. Morse theory and a nonlinear generalization of the Dirichlet problem. *Annals of Math.* 80 (1964), 382–396.

Steenrod, N.

1. *The Topology of Fibre Bundles*. Princeton University Press, Princeton, 1951.

Takens, F.

1. A note on sufficiency of jets. *Invent. Math.* 13 (1971), 225–231.

Thom, R.

1. Quelques propriétés globales des variétés différentiables. *Comm. Math. Helv.* 28 (1954), 17–86.

Van Douwen, E. K.

1. The box product of countably many metrizable spaces need not be normal. *Fund. Math.* 88 (1975), 127–132.

Whitehead, J. H. C.

1. On  $C^1$  complexes. *Annals of Math.* 41 (1940), 809–824.

Whitney, H.

1. A function not constant on a connected set of critical points. *Duke Math. J.* 1 (1935), 514–517.
2. Differentiable manifolds. *Annals of Math.* 37 (1936), 645–680.
3. On the topology of differentiable manifolds. In R. L. Wilder, *Lectures in Topology*, University of Michigan Press, Ann Arbor, 1941.
4. The selfintersections of a smooth  $n$ -manifold in  $2n$ -space. *Annals of Math.* 45 (1944), 220–246.
5. The singularities of a smooth  $n$ -manifold in  $(2n - 1)$  space. *Annals of Math.* 45 (1944), 247–293.
6. Analytic extensions of differentiable functions defined in closed sets. *Trans. Amer. Math. Soc.* 36 (1934), 63–89.

## Appendix

In this appendix we briefly summarize a few basic facts of analysis and topology.

### General Topology

A topological space  $X$  is called:

*Hausdorff* if every pair of points have disjoint neighborhoods;

*normal* if for every pair of disjoint closed sets  $A, B$  there is a continuous map  $f: X \rightarrow [0,1]$  with  $f(A) = 0$  and  $f(B) = 1$ ;

*paracompact* if every open cover  $\mathcal{U} = \{U_\lambda\}_{\lambda \in A}$  has a locally finite open refinement  $\mathcal{V} = \{V_\gamma\}_{\gamma \in I}$ . This means:  $\mathcal{V}$  is an open cover of  $X$ , each element of  $\mathcal{V}$  is contained in some element of  $\mathcal{U}$ , and for each  $x \in X$  the set of  $V_\gamma$  for which  $x \in V_\gamma$  is finite.

The closure of a subset  $S \subset X$  is denoted by  $\bar{S}$ .

**A.1. Theorem.** *If  $X$  is normal and  $\mathcal{U} = \{U_\lambda\}_{\lambda \in A}$  is a locally finite open cover then  $\mathcal{U}$  has a shrinking, that is, an open cover  $\mathcal{V} = \{V_\lambda\}_{\lambda \in A}$  such that  $\bar{V}_\lambda \subset U_\lambda$ .*

**A.2. Theorem.** *A paracompact Hausdorff space is normal.*

A *partition of unity* subordinate to the open cover  $\mathcal{U}$  is a collection  $\{f_\lambda\}_{\lambda \in A}$  of continuous maps  $f_\lambda: X \rightarrow [0,1]$  having the following two properties: the family of open sets  $\{f_\lambda^{-1}(0,1]\}_{\lambda \in A}$  is a locally finite refinement of  $\mathcal{U}$ ; and  $\sum_{\lambda \in A} f_\lambda(x) = 1$  for all  $x$ .

**A.3. Theorem.** *A topological space is paracompact if and only if every open cover has a subordinate partition of unity.*

**A.4. Theorem.** *Every metric space is paracompact.*

A subset  $A$  of a space  $X$  is *nowhere dense* if its closure  $\bar{A}$  contains no nonempty open set; equivalently,  $X - \bar{A}$  is dense in  $X$ . If  $X$  is the union of a countable family of closed nowhere dense subsets  $X$  is of the *first category*; otherwise  $X$  is of the *second category*.

**A.5. Baire Category Theorem.** *A complete metric space  $X$  is of the second category. Equivalently: the union of any countable collection of closed nowhere dense subsets has void interior, and the intersection of any countable collection of open dense subsets is dense.*

## Calculus

Let  $U \subset \mathbb{R}^m$  be an open set and  $f: U \rightarrow \mathbb{R}^n$  a map. A linear map  $L: \mathbb{R}^m \rightarrow \mathbb{R}^n$  is called the *derivative of  $f$  at  $x \in U$*  if

$$\lim_{h \rightarrow 0} |h|^{-1}(f(x+h) - f(x) - Lh) = 0.$$

Here  $|h|$  is the norm  $\left(\sum_{j=1}^m h_j^2\right)^{1/2}$  of the vector  $h = (h_1, \dots, h_m) \in \mathbb{R}^m$ . If such an  $L$  exists, it is unique and is denoted by  $Df_x$  or  $Df(x)$ .

The map  $f$  is called  $C^1$  provided  $Df_x$  exists for every  $x \in U$  and the map

$$\begin{aligned} Df: U &\rightarrow L(\mathbb{R}^m, \mathbb{R}^n), \\ x &\mapsto Df_x \end{aligned}$$

is continuous.

By recursion we define  $f$  to be  $C^r$ ,  $2 \leq r < \infty$ , if the map

$$Df: U \rightarrow \mathbb{R}^{mn} = L(\mathbb{R}^m, \mathbb{R}^n)$$

is  $C^{r-1}$ . If  $f$  is  $C^r$  for all  $r$  it is called  $C^\infty$ .

Write  $f(x) = (f_1(x), \dots, f_n(x))$ . We call  $f$  (*real*) *analytic*, or  $C^\omega$ , if in some neighborhood of each point of  $U$ , each  $f_j$  is equal to the limit of a convergent power series (in  $m$  variables). This implies that  $f$  is  $C^\infty$ . We say  $\infty \leq \omega$ .

**A.6. Theorem.**  $f$  is  $C^r$ ,  $1 \leq r < \infty$ , if and only if each  $f_j: U \rightarrow \mathbb{R}$  has continuous partial derivatives of all orders  $\leq r$ .

Let  $U$  and  $V$  be open subsets of  $\mathbb{R}^n$ . A  $C^r$  diffeomorphism  $f: U \rightarrow V$  is a  $C^r$  homeomorphism  $f: U \approx V$  whose inverse is also  $C^r$ .

Let  $W \subset \mathbb{R}^n$  be open, and  $p \in W$ . A  $C^r$  map  $f: W \rightarrow \mathbb{R}^n$  is a *local diffeomorphism at  $p$*  if there is an open set  $U \subset W$  such that  $p \in U$  and  $f(U)$  is open, and  $f|_U: U \approx f(U)$  is a  $C^r$  diffeomorphism.

**A.7. Inverse Function Theorem.** Let  $U \subset \mathbb{R}^n$  be an open set and  $f: U \rightarrow \mathbb{R}^n$  a  $C^r$  map,  $1 \leq r \leq \omega$ . If  $p \in U$  and  $Df_p$  is invertible, then  $f$  is a  $C^r$  local diffeomorphism at  $p$ .

**A.8. Implicit Function Theorem (surjective form).** Let  $U \subset \mathbb{R}^m$  be an open set and  $f: U \rightarrow \mathbb{R}^n$  a  $C^r$  map,  $1 \leq r \leq \omega$ . Let  $p \in U$ ,  $f(p) = 0$ , and suppose that  $Df_p$  is surjective. Then there exists a local diffeomorphism  $\varphi$  of  $\mathbb{R}^m$  at 0 such that  $\varphi(0) = p$  and

$$f\varphi(x_1, \dots, x_m) = (x_1, \dots, x_n).$$

*Proof.* After a linear change of coordinates in  $\mathbb{R}^m$  we can assume that  $\frac{\partial f_i}{\partial x_j}(p) = \delta_{ij}$  for  $i = 1, \dots, n$  and  $j = 1, \dots, m$ . Define  $h: U \rightarrow \mathbb{R}^n$ ,  $h = (h_1, \dots, h_m)$  where  $h_i = f_i$ ,  $i = 1, \dots, n$  and  $h_i(x_1, \dots, x_m) = x_i$ ,  $i = n+1, \dots, m$ . Then  $h$  is  $C^r$  and  $Dh_p$  has rank  $m$ . By the inverse function

theorem  $h$  is a  $C^r$  local diffeomorphism at  $p$ . Therefore in a neighborhood of 0 in  $\mathbb{R}^m$ ,  $h$  has a  $C^r$  inverse  $\varphi$ . Then  $h(\varphi(x)) = x$  for  $x$  near 0; this  $\varphi$  satisfies the theorem.

QED

**A.9. Implicit Function Theorem (injective form).** Let  $U \subset \mathbb{R}^m$  be an open set and  $f: U \rightarrow \mathbb{R}^n$  a  $C^r$  map,  $1 \leq r \leq \omega$ . Let  $q \in \mathbb{R}^n$  be such that  $0 \in f^{-1}(q)$ , and suppose that  $Df_0$  is injective. Then there is a local diffeomorphism  $\psi$  of  $\mathbb{R}^n$  at  $q$  such that  $\psi(q) = 0$ , and

$$\psi f(x) = (x_1, \dots, x_m, 0, \dots, 0).$$

The proof is "dual" to that of Theorem A.8 and is left as an exercise.

# Index

## A

- Abraham, R., 80
- Absolute neighborhood retract, 15
- Alexandroff, P., 141
- Algebraic variety, 66
- Antipodal map, 106, 122, 183
- Approximation, 44–50, 56–58. *See also*
  - Denseness
  - algebraic, 66
  - analytic, 65–66
  - by embeddings, 26, 27
  - by homotopic maps, 124
  - by immersions, 27
  - of sections, 56, 83, 134
- Artin, M., 66
- Atlas, 9, 11
  - oriented, 104–105
  - on a set, 14
  - for vector bundles, 87
  - orthogonal, 96

## B

- Baire category theorem, 213
- Baire subset, 65
- Ball. *See* Disk
- Base space, 87
- Betti numbers, 161. *See also* Morse inequalities
  - of  $CP^n$ , 167
  - of  $P^n$ , 165
- Bimorphism, 88, 98
- Bochner, S., 66
- Bordism groups, 176
- Boundary of manifold, 29–32
- Bounded velocity, 180–181
- Brouwer, L.E.J., 141
  - fixed point theorem of, 73
- Brown, A.B., 67
- Brown, M., 21
- Bump function, 41
- Bundle of  $n$ -planes, 87. *See also* Vector Bundle

## C

- Canonical homotopy, 112
- Cell, 157, 160. *See also* Disk
  - theorem of M. Brown, 21
- Cerf, J., 187
- Characteristic
  - Euler. *See* Euler characteristic
  - of system of functions, 140
- Chart, 9, 11
  - adapted, 15
  - natural, 17, 143
  - for vector bundle, 86

- Chrystal, G., 7
- Classification, 3. *See also* Homotopy classes
  - of differential structures, 187
  - of 1-manifolds, 32
  - of  $n$ -plane bundles over  $S^1$ , 108
  - of oriented  $k$ -plane bundles, 108
  - of surfaces, 200–208
  - of vector bundles, 99–103
    - over spheres, 103
- Classifying map, 100
- Classifying space, 102
- Cobordism, 5, 169–176, 207
- Cobordant manifolds, 169, 170, 176
- Cocycle of vector bundle atlas, 87
- Codimension, 13
- Collar, 113
  - on  $C^\infty$  submanifold, 114
  - on neat submanifold, 118
  - on nonparacompact manifold, 118
- Collaring theorem, 113, 152
- Collation of differential structures, 13
- Commutative diagram, 19
- Compactification, 172
- Complex projective space, 14. *See also*
  - Intersection numbers; Morse functions; Projective space
  - as  $CW$ -complex, 167
  - and cobordism groups, 175
- Composition map, 64
- Connected sum, 191, 194
- Connection, 99
- Connectivity, 2, 188–189, 208
- Convolution, 45–47
- Coordinate system, 8–12
- Cotangent bundle, 143
- Covering homotopy theorem, 85, 89–92, 98
- Critical points, 22. *See also* Morse function;
  - Morse inequalities
  - and gradients, 152, 164
  - nondegenerate, 143–147
  - index of, 144
- Critical value, 22
- Crosscap, 192
- Cube, 68
- $CW$ -complex, 166–168

## D

- Degree of map, 4, 120–131
  - of  $CP^n$ , 140
- Denseness. *See also* Approximation
  - of embeddings, 35, 54–55, 62–63
  - of immersions, 35, 53, 82
  - of Morse functions, 147
  - of polynomials, 66

Derivative, 214  
 notation for, 19–20  
 Diagonal, 25  
 Diagonalization of symmetric matrices, 145  
 Diffeomorphisms, 16. *See also* Diffeotopy;  
 Isotopy; Openness  
 of  $CP^2$ , 140  
 differentiability class of, 20, 50, 52  
 by following flow lines, 153, 156  
 local, 214  
 one-parameter group of, 151  
 of open sets on  $\mathbb{R}^n$ , 214  
 preserving or reversing orientation, 105,  
 109, 207  
 of  $S^n$ , 106, 187  
 of surfaces, 207  
 Diffeomorphism groups of  $\mathbb{R}^n$  and  $S^n$ , 187  
 Diffeotopy, 178–179, 182. *See also* Isotopy  
 of  $S^1$ , 186  
 of surfaces in  $\mathbb{R}^3$ , 184  
 Differential equations, 149–152  
 Differential structures, 12–14  
 analytic, 118  
 compatible, 51  
 existence and uniqueness of, 51–52,  
 57–58  
 oriented, 105  
 on  $S^n$ , group of, 187  
 Dimension  
 of manifold, 11  
 of vector bundle, 87  
 Direct sum of vector bundles. *See* Whitney  
 sum  
 Disk  
 open, 9  
 characterization of, 194, 199  
 closed, 23  
 unit, 23n  
 with holes, 203  
 Double of manifold, 32  
 Double covering, oriented, 105–106  
 Dubovickii, A. Ya., 67n  
**E**  
 Embeddings, 27. *See also* Approximation;  
 Denseness; Extension; Isotopy;  
 Openness  
 in Euclidean space, 23–29, 31  
 level-preserving, 178  
 nonorientable, 190  
 of collar, 152  
 orientable, 190  
 of  $P^n$ , 29, 108  
 of  $S^{k-1}$ , unknotted, 187  
 End of noncompact surface, 208  
 Epimorphism of vector bundles, 88, 98  
 Euler characteristic, 133–135  
 and critical submanifolds, 165  
 homological, 161, 164, 166  
 mod 2, 172

of orientable surface, 139  
 product formula, 166  
 as self-intersection of diagonal, 138  
 of surfaces, 204–205, 207, 208  
 Euler number, 121, 133  
 of vector bundle over  $S^n$ , 140  
 Exact sequence of vector bundles, 93–95  
 Extension. *See also* Isotopy  
 of diffeomorphisms, 186, 207  
 of embeddings, 58, 180, 183  
 of  $S^{k-1}$ , 187  
 of maps into  $S^n$ , 126–127  
 of tubular neighborhoods, 115, 118  
 of vector bundles, 91  
 of vector bundle morphisms, 92

**F**

Fibre, 87  
 Fibre derivative, 112  
 Fibre dimension, 87  
 Fibre map, 88  
 First category, 213  
 Fixed points, 73  
 and Euler characteristic, 138  
 of iterates, 66  
 and Lefschetz number, 139  
 in  $P^{2n}$ , 139  
 Flow, 149–151  
 Frame bundle, 98  
 Framed cobordism, 176  
 Frenchmen, 169  
 Fundamental theorem of algebra, 125  
 generalization of, 131  
 Fundamental theorem of cobordism, 174

**G**

Gauss map, 182  
 Gauss–Bonnet theorem, 141  
 General position, 4, 78  
 Genus of surface, 28, 139, 172, 189, 191, 205  
 Germs, 53, 91  
 Globalization, 52  
 theorems, 53, 75  
 Gluing manifolds, 184  
 Goethe, 169  
 Gradient. *See* Vector field gradient  
 Grassmann bundle, 99, 173, 174  
 Grassmann manifold, 14, 102, 108, 118,  
 171–175  
 Grauert, H., 65

**H**

Hadamard, J., 141  
 Harrison, J., 156  
 Hairy ball theorem, 125  
 Handle, attaching of, 189  
 Halfspace, 29  
 Hanner, O., 15

Heegard, P., 7, 85  
 Hessian  
 matrix, 143  
 quadratic form, 144–147  
 Homotopy classes  
 of maps into  $S^n$ , 4, 129, 130, 176  
 of maps into Thom spaces, 175  
 Homotopy extension theorem, 90  
 Hopf, H., 141, 169, 210  
 theorem of, 164  
 Horizontal part of vector field, 178  
 Hurewicz, W., 27, 30, 210  
**I**  
 Immersions, 21. *See also* Denseness;  
 Approximation; Openness  
 with clean double points, 82  
 in general position, 82  
 injective, 27, 41  
 Implicit function theorem, 214–215  
 generalization, 7  
 Index  
 of critical point, 144  
 of critical submanifold, 149  
 of quadratic form, 144  
 of zero of vector field, 133, 136  
 Induced differential structure, 13  
 Induced vector bundle, 97  
 Inner product, 95, 152  
 Inset, 165  
 Integral curve, 150  
 Intersection number, 120, 132–133  
 of complex projective subspaces, 138  
 and degree, 140  
 of maps, 139, 176  
 Inverse vector bundle, 100, 103  
 Inverse function theorem, 22, 214  
 Isomorphism of vector bundles, 88  
 Isotopy, 111, 177–184. *See also* Diffeotopy  
 ambient, 118, 178, 183  
 of disks, 185–187  
 of embeddings of  $D^n$ , 117, 185–187  
 of embeddings of  $\mathbb{R}^n$ , 117  
 extension theorems, 180  
 of knotted line, 183  
 proper, 183  
 rel  $A$ , 111  
 of tubular neighborhoods, 111–113,  
 116–118

**J**

Jet, 60–63, 65  
 transversality theorem, 80  
 Jordan, C., 188

**K**

Kernel of vector bundle epimorphism, 93  
 Kervaire, M., 16, 210

Klein bottle, 192  
 Klein, F., 34, 85, 177  
 Kneser, H., 15  
 Kneser, M., 15, 210  
 Koch, W., 15  
 Kronecker, L., 140–141  
 Kuiper, N., 148

**L**

Lefschetz number, 139  
 Lefschetz, S., 141  
 fixed point theorem of, 139  
 Lickorish, W. B. R., 194  
 Lie group, 92, 108  
 Limit set  
 of map, 65  
 of vector field, 164  
 Line with two origins, 15, 28  
 Linking number, 130  
 Localization axiom, 75  
 Locally finite:  
 refinement, 213  
 set of charts, 35  
 Local representation of map, 15  
 Long line, 15, 118

**M**

Manifolds, 1, 11–15  
 assumptions regarding, 33, 67  
 with boundary, 29–31  
 Nash, 211  
 non-Hausdorff, 15, 32  
 nonparacompact, 15, 32  
 nonsmoothable, 16  
 one-dimensional, 20  
 orientable, 32, 105, 131  
 oriented, 105, 121  
 paracompact, 33  
 parallelizable, 88  
 reversible, 190, 194  
 smooth, 12  
 Manifold pair, 57  
 Map  
 analytic, 34, 214  
 closed, 40  
 $C^r$ , 9, 15–16  
 between open subsets of Euclidean  
 space, 9, 214  
 between submanifolds of Euclidean  
 space, 9–11  
 differentiable, 15  
 immersive, 21  
 locally trivial, 85  
 proper, 38  
 submersive, 21  
 Mapping class, 75  
 Mathematicians, 169  
 Mazur, B., 66  
 Measure zero, 68



Milnor, J., 142, 155  
 Möbius, A.F., 4, 188  
 Möbius band, 27, 189, 191, 206–208  
 Möbius number of surface, 206  
 Monomorphism of vector bundles, 88, 98, 99  
 Morphism of vector bundles, 88, 98, 99  
 Morrey, C. B., 66  
 Morse, A. P., 67  
 Morse equality, generalized, 165  
 Morse functions, 142–149, 199  
   admissible, 156  
   on  $CP^n$ , 167  
   on  $P^n$ , 149, 165  
   on surfaces, 165, 194–204  
   with four critical points, 200  
   with three critical points, 194, 199  
   with two critical points, 154, 156  
   with unique maximum and unique minimum, 200  
 Morse inequalities, 160–164  
 Morse, M., 1, 4, 142, 145  
 Morse–Sard theorem, 69  
 Morse's lemma, 145, 146, 148, 149  
   generalized, 149  
 Morse theory, 142  
 Munkres, J., 187

## N

Nash, J., 66  
 Nash manifolds, 211  
 Normal bundle, 95–96. *See also* Section;  
   Vector field  
   of codimension-one submanifold,  
     107–108  
   of  $\partial M$ , 106  
   of  $P^k$  in  $P^{k+1}$ , 98  
   as pullback, 171  
   trivial, 108, 113  
 Nowhere dense set, 213

## O

One-point compactification, 172  
 Openness of certain sets of maps, 36–41  
   of Morse functions, 147  
 Orientation, 103–106, 121–122  
 Orthogonal complement of vector bundle, 95  
 Orthogonal group, 14, 187  
 Orthogonal structure, 95  
 Outset, 165

## P

Palais, R., 142  
 Parallelizability  
   of frame bundle, 98  
   of product of spheres, 98  
 Partition of unity, 213  
   of class  $C^r$ , 43  
   used to glue maps, 44

Periodic points  
   theorem of Artin and Mazur, 66  
   theorem of Shub and Sullivan, 140  
 Plane bundle, 87. *See also* Vector bundle  
 Poincaré, H., 2, 4, 211  
 Poincaré's conjecture, 2  
 Polynomial maps, 28, 199  
 Pontryagin, L. S., 27, 141  
 Projection of vector bundle, 87  
 Projective spaces, 13, 14, 28, 29, 98, 108,  
   138, 139, 140, 149, 175  
 Prolongation, 61  
 Pullback of vector bundle, 97, 171  
 Puppe, D., 15  
 Punctured torus, immersions of, 27

## Q

Quadratic form, 20, 142, 144  
 Quaternionic projective space, 14  
 Quotient vector bundle, 93

## R

Real projective space, 13. *See also* Betti  
   numbers; Embeddings; Morse  
   functions  
   of dimension-2, 20  
   of dimension-3, 20, 28  
   as Thom space, 175  
 Red herring principle, 22n  
 Reeb, G., theorem of, 154  
 Regular interval theorem, 153  
 Regular level surface, 9, 22, 28, 149–155  
 Regular point, 22  
 Regular value, 14, 22  
   theorem, 22, 27, 31  
   knotted curve as inverse image of, 32  
 Relative approximation theorem, 49  
 Remmert, R., 65  
 Residual subset, 74  
 Restriction map, 41  
 Retraction  
   of class  $C^r$ , 20  
   of  $D^n$  to  $S^{n-1}$ , nonexistence of, 72  
 Riemannian metric, 95, 178, 180  
 Riemann, G.F.B., 1, 188  
 Riemann surface, 1  
 Riemann's connectivity, 208

## S

Saddle, 204  
 Sard, A., 67  
   theorem of. *See* Morse–Sard theorem  
 Schweitzer, P., 156  
 Second category, 213  
 Sections  
   of map, 56  
   of  $TS^n$ , 98

  of vector bundle, 133–140. *See also* Vector  
   field  
   of normal vector bundle, 86, 138, 140  
 Semi-orbit, 156  
 Separable, 15  
 Separation by submanifold, 107–108  
 Shiata, 66  
 Shub, M., 140, 188  
 Shrinking of covering, 43, 213  
 Smale, S., 16, 142, 187, 200  
 Smoothing theorem, 181  
 Smooth manifold, 12  
 Solution curve, 149, 150  
 Space  
   Hausdorff, 33, 213  
   normal, 65, 213  
   paracompact, 33, 65, 213  
   Baire, 59–62, 64, 65, 214  
 Sphere  
   as Thom space, 175  
   characterization of, 156, 187  
   differential structure on, 13  
   exotic, 155  
   group of differential structures on, 187  
   unit, 8  
   with handles, 204  
 Stable manifold, 164  
 Stably isomorphic vector bundles, 102  
 Standard form of map, 173  
 Stiefel manifold, 78  
 Structure functor, 52  
 Subbundle, 92  
 Submanifold, 13, 21–22  
   assumed to be  $C^\infty$ , 67  
   critical, 161, 165  
   framed, 176  
   locally flat, 13n  
   of manifold with boundary, 30–31  
   neat, 30  
   of  $R^{n+k}$ , 10  
 Submanifold complex, 84  
 Submersion, 21  
 Sullivan, D., 140  
 Support  
   of function, 43  
   of isotopy, 179  
   radius of, 45  
   of time-dependent vector field, 179  
 Surface, 188. *See also* Classification; Genus;  
   Euler characteristic, 139  
   model, 189–193  
   noncompact, 207, 208  
   nonorientable, 191  
   reversible, 190  
 Surgery, 189  
 Suspension homomorphism, 183–184

## T

Takens, F., 148  
 Tangent bundle, 11, 88

  of  $M \times N$ , 21  
   of  $S^n$ , 20, 98  
   of total space, 94–95  
   unit, 26  
 Tangent functor, 7, 89  
 Tangent space, 11, 17  
 Tangent vector, 11, 16–19  
 Thom, R., 1, 5, 120, 142, 188  
   awarded Fields Medal, 169  
   theorems of, 174, 175  
 Thom homomorphism, 173–174  
 Thom space of vector bundle, 172–175  
 Topology.  
   compact-open, 58  
   compact-open  $C^r$ , 34  
   fine, 35  
   strong, 59, 64, 65  
   strong  $C^r$ , 35, 40, 41  
   weak  $C^r$ , 34–35  
   Whitney, 35  
 Total space of vector bundle, 87  
 Trajectory, 149, 151  
 Transition functions, 87  
 Transversality, 4, 22, 74–84  
 Trivialization of vector bundle, 88  
 Tubular neighborhoods, 109–118  
 Tubular neighborhood theorem, 112, 116  
   ambient, 181  
 Type number of Morse function, 160

## U

Universal bundle, 99  
 Unstable manifold, 165

## V

Van Douwen, 65  
 Van Dyck, W., 141  
 Vector bundle, 4–5, 17, 85–92. *See also*  
   Classification; Normal bundle;  
   Section  
   nonorientable, 109  
   one-dimensional, 106  
   orientable, 104–106, 108  
   orthogonal, 95–96  
   over  $S^n$ , 103, 140  
 Vector bundle map, 88  
   natural, 97  
 Vector fields, 133. *See also* Sections  
   and differential equations, 149–153,  
     155–156, 164  
   and isotopy, 178–181  
   bounded velocity, 155  
   gradient, 152  
   time-dependent, 178

## W

Wallman, H., 27, 30  
 Weyl, H., 2, 7, 120

Whitehead, A. N., 85  
 Whitehead, J. H. C., 67  
 Whitney, H., 2, 24, 27, 55, 66, 118, 138  
   theorems on  
     embeddings, 24, 27  
     immersions, 27  
     existence of normal vector fields, 138

Whitney sum of vector bundles, 94, 102  
 Winkelkemper, H. E., 67

## Z

Zero section of vector bundle, 87

## Graduate Texts in Mathematics

*continued from page ii*

- 65 WELLS. *Differential Analysis on Complex Manifolds*. 2nd ed.
- 66 WATERHOUSE. *Introduction to Affine Group Schemes*.
- 67 SERRE. *Local Fields*.
- 68 WEIDMANN. *Linear Operators in Hilbert Spaces*.
- 69 LANG. *Cyclotomic Fields II*.
- 70 MASSEY. *Singular Homology Theory*.
- 71 FARKAS/KRA. *Riemann Surfaces*. 2nd ed.
- 72 STILLWELL. *Classical Topology and Combinatorial Group Theory*. 2nd ed.
- 73 HUNGERFORD. *Algebra*.
- 74 DAVENPORT. *Multiplicative Number Theory*. 2nd ed.
- 75 HOCHSCHILD. *Basic Theory of Algebraic Groups and Lie Algebras*.
- 76 ITAKA. *Algebraic Geometry*.
- 77 HECKE. *Lectures on the Theory of Algebraic Numbers*.
- 78 BURRIS/SANKAPPANAVAR. *A Course in Universal Algebra*.
- 79 WALTERS. *An Introduction to Ergodic Theory*.
- 80 ROBINSON. *A Course in the Theory of Groups*.
- 81 FORSTER. *Lectures on Riemann Surfaces*.
- 82 BOTT/TU. *Differential Forms in Algebraic Topology*.
- 83 WASHINGTON. *Introduction to Cyclotomic Fields*.
- 84 IRELAND/ROSEN. *A Classical Introduction to Modern Number Theory*. 2nd ed.
- 85 EDWARDS. *Fourier Series*. Vol. II. 2nd ed.
- 86 VAN LINT. *Introduction to Coding Theory*. 2nd ed.
- 87 BROWN. *Cohomology of Groups*.
- 88 PIERCE. *Associative Algebras*.
- 89 LANG. *Introduction to Algebraic and Abelian Functions*. 2nd ed.
- 90 BRØNDSTED. *An Introduction to Convex Polytopes*.
- 91 BEARDON. *On the Geometry of Discrete Groups*.
- 92 DIESTEL. *Sequences and Series in Banach Spaces*.
- 93 DUBROVIN/FOMENKO/NOVIKOV. *Modern Geometry—Methods and Applications*. Part I. 2nd ed.
- 94 WARNER. *Foundations of Differentiable Manifolds and Lie Groups*.
- 95 SHRYAYEV. *Probability*.
- 96 CONWAY. *A Course in Functional Analysis*. 2nd ed.
- 97 KOBLITZ. *Introduction to Elliptic Curves and Modular Forms*. 2nd ed.
- 98 BRÖCKER/TOM DIECK. *Representations of Compact Lie Groups*.
- 99 GROVE/BENSON. *Finite Reflection Groups*. 2nd ed.
- 100 BERG/CHRISTENSEN/RESSEL. *Harmonic Analysis on Semigroups: Theory of Positive Definite and Related Functions*.
- 101 EDWARDS. *Galois Theory*.
- 102 VARADARAJAN. *Lie Groups, Lie Algebras and Their Representations*.
- 103 LANG. *Complex Analysis*. 3rd ed.
- 104 DUBROVIN/FOMENKO/NOVIKOV. *Modern Geometry—Methods and Applications*. Part II.
- 105 LANG.  $SL_2(\mathbb{R})$ .
- 106 SILVERMAN. *The Arithmetic of Elliptic Curves*.
- 107 OLVER. *Applications of Lie Groups to Differential Equations*. 2nd ed.
- 108 RANGE. *Holomorphic Functions and Integral Representations in Several Complex Variables*.
- 109 LEHTO. *Univalent Functions and Teichmüller Spaces*.
- 110 LANG. *Algebraic Number Theory*.
- 111 HUSEMÖLLER. *Elliptic Curves*.
- 112 LANG. *Elliptic Functions*.
- 113 KARATZAS/SHREVE. *Brownian Motion and Stochastic Calculus*. 2nd ed.
- 114 KOBLITZ. *A Course in Number Theory and Cryptography*. 2nd ed.
- 115 BERGER/GOSTIAUX. *Differential Geometry: Manifolds, Curves, and Surfaces*.
- 116 KELLEY/SRINIVASAN. *Measure and Integral*. Vol. I.
- 117 SERRE. *Algebraic Groups and Class Fields*.
- 118 PEDERSEN. *Analysis Now*.
- 119 ROTMAN. *An Introduction to Algebraic Topology*.
- 120 ZIEMER. *Weakly Differentiable Functions: Sobolev Spaces and Functions of Bounded Variation*.

- 121 LANG. Cyclotomic Fields I and II. Combined 2nd ed.
- 122 REMMERT. Theory of Complex Functions. *Readings in Mathematics*
- 123 EBBINGHAUS/HERMES et al. Numbers. *Readings in Mathematics*
- 124 DUBROVIN/POMENKO/NOVIKOV. Modern Geometry—Methods and Applications. Part III.
- 125 BERENSTEIN/GAY. Complex Variables: An Introduction.
- 126 BOREL. Linear Algebraic Groups.
- 127 MASSEY. A Basic Course in Algebraic Topology.
- 128 RAUCH. Partial Differential Equations.
- 129 FULTON/HARRIS. Representation Theory: A First Course. *Readings in Mathematics*
- 130 DODSON/POSTON. Tensor Geometry.
- 131 LAM. A First Course in Noncommutative Rings.
- 132 BEARDON. Iteration of Rational Functions.
- 133 HARRIS. Algebraic Geometry: A First Course.
- 134 ROMAN. Coding and Information Theory.
- 135 ROMAN. Advanced Linear Algebra.
- 136 ADKINS/WEINTRAUB. Algebra: An Approach via Module Theory.
- 137 AXLER/BOURDON/RAMEY. Harmonic Function Theory.
- 138 COHEN. A Course in Computational Algebraic Number Theory.
- 139 BREDON. Topology and Geometry.
- 140 AUBIN. Optima and Equilibria. An Introduction to Nonlinear Analysis.
- 141 BECKER/WEISPFENNING/KREDEL. Gröbner Bases. A Computational Approach to Commutative Algebra.
- 142 LANG. Real and Functional Analysis. 3rd ed
- 143 DOOB. Measure Theory.
- 144 DENNIS/FARB. Noncommutative Algebra.
- 145 VICK. Homology Theory. An Introduction to Algebraic Topology. 2nd ed.
- 146 BRIDGES. Computability: A Mathematical Sketchbook.
- 147 ROSENBERG. Algebraic K-Theory and Its Applications.
- 148 ROTMAN. An Introduction to the Theory of Groups. 4th ed.
- 149 RATCLIFFE. Foundations of Hyperbolic Manifolds.
- 150 EISENBUD. Commutative Algebra with a View Toward Algebraic Geometry.
- 151 SILVERMAN. Advanced Topics in the Arithmetic of Elliptic Curves.
- 152 ZIEGLER. Lectures on Polytopes.
- 153 FULTON. Algebraic Topology: A First Course.
- 154 BROWN/PEARCY. An Introduction to Analysis.
- 155 KASSEL. Quantum Groups.
- 156 KECHRIS. Classical Descriptive Set Theory.